

AUGUST - 1945

# electronics

A MCGRAW-HILL PUBLICATION



OMNI-DIRECTIONAL RADIO RANGES

# THE AMPEREXTRA FACTOR in INDUCTION HEATING

The Amperextra Factor is the longer operating life and lower maintenance cost of Amperex air and water cooled transmitting and rectifying tubes. In induction heating, a field in which our engineers have pioneered, this Factor adds considerably to the general efficiency of equipment using Amperex tubes.



## LONGER LIFE . . .

. . . since the life of a tube is influenced by the equipment in which it is used, as well as by the inherent characteristics of the tube itself, we maintain a Special Engineering Application Department which constantly applies our tubes in actual circuits, and determines which conditions are conducive to prolonged life. Their findings are freely available to you.



## FIGURED . . .

. . . on the basis of the hours of maximum tube life, Amperex tubes are by far your best and most economical "buy."



## LOWER MAINTENANCE COST . . .

. . . Amperex tubes offer more value per dollar invested. Down time is noticeably decreased, number of replacements minimized, overall costs reduced.

## AMPEREX

### performance tube

The Amperex Special Application Engineering Department, another "Amperextra," will be glad to work with you on present or postwar problems.



*Amperex Type 575-A Mercury Vapor Rectifier. Filament AC voltage, 5.0 volts. Filament current, 10.0 amperes. Preheating period, before plate voltage is applied, 30 seconds. \$30.00, list price.*



*Amperex Type 889-R Transmitting Tube. Filament voltage, 11 volts. Filament current, 125 amperes. Amplification factor, 21. Direct interelectrode capacitance: Grid to plate, 20.7  $\mu\text{f}$ : Grid to filament, 19.5  $\mu\text{f}$ : Plate to filament, 2.5  $\mu\text{f}$ . \$260.00, list price.*



*Amperex Type HF-100 Transmitting Tube. Filament Voltage, 10-10.5 volts. Filament current, 2.5 amperes. Amplification factor, 23. Grid to plate transconductance at 100 ma., 4200. Direct interelectrode capacitance: Grid to plate, 4.5  $\mu\text{f}$ : grid to filament, 3.5  $\mu\text{f}$ : plate to filament, 1.4  $\mu\text{f}$ . \$12.50, list price.*

## AMPEREX TUBES . . .

. . . for induction heating applications range from small 50 watt types to "big boys" of 100,000 watts. Many of these tube types are now available through leading radio equipment distributors.

# AMPEREX ELECTRONIC CORPORATION

25 Washington St., Brooklyn 1, N.Y., Export Division: 13 E. 40th St., New York 16, N.Y., Cables: "Arlab"

Canadian Distributor: Rogers Electronic Tubes, Limited • 622 Fleet Street West, Toronto

# electronics

A McGRAW-HILL PUBLICATION



AUGUST • 1945

OMNI-DIRECTIONAL RADIO RANGES.....		Cover
Artist Jack LaBous' conception of plane using signals from two stations 100 miles apart to obtain a position fix. Dotted lines indicate 10-degree units of azimuth transmitted by new CAA vhf system		
SURPLUS EQUIPMENT DISPOSAL PLAN, by G. T. Montgomery .....	92	
Details of government-designed machinery under which obsolete military electronic gear is marketed		
MOTOR NOISE UNIT FOR AIRCRAFT TRAINER, by Byron E. Phelps.....	96	
Noise resembling that of an airplane motor is produced by a multivibrator and sub-harmonic generators		
REMOTE TUNING WITH REACTANCE TUBES, by H. Bard.....	100	
Receivers are tuned over a limited band, by means of d-c transmitted over telephone lines		
ELECTRONIC CONTROL FOR MAGNETIC CLUTCHES, by Ralph L. Jaeschke.....	102	
A preset motor speed is maintained within 0.1 percent for all load variations up to full load		
F-M ANTENNA COUPLER, by John P. Taylor.....	107	
Feeding an f-m antenna without shorting an a-m tower on which it is mounted		
INDUCTION AND DIELECTRIC HEATING EQUIPMENT .....	110	
Performance and cost data on commercially available induction and dielectric heating equipment.		
SURVEY OF D-C AMPLIFIERS, by Maurice Artzt .....	112	
Causes of drift, performance characteristics of 12 different circuits, and oscilloscope applications		
HIGH-Q IRON-CORED INDUCTOR CALCULATIONS, by Stephen L. Javna.....	119	
Analytic approach to core and coil calculations results in highest-Q inductor		
HARMONIC SUPPRESSION FOR AIRCRAFT GENERATORS, by F. W. Jaksha.....	124	
Procedure for designing low-cost series resonant filters to suppress harmonics in output		
STUDIO AND CONTROL-ROOM DESIGN, by William Reagh Hutchins.....	126	
Equipment and space requirements for studio and control room of student-operated station		
QUARTZ CRYSTAL IMPROVEMENTS, by C. W. Franklin.....	130	
Advances in crystal manufacturing methods hold promise for future		
SQUARE-WAVE DIFFERENTIATING CIRCUIT ANALYSIS, by G. P. Ohman.....	132	
Development of charts giving pulse amplitude and length for input of finite wave-front slope		
GRAPHICAL SYMBOLS FOR ELECTRONIC DIAGRAMS .....	136	
Most-used schematic symbols abstracted from ASA bulletins and arranged in chart form for convenient reference		
STABILIZED NEGATIVE IMPEDANCES, PART II, by E. L. Ginzton.....	138	
Charts for predicting effects on negative impedances of frequency variations in amplifier characteristics		
FCC ANNOUNCES FINAL F-M AND TELEVISION ALLOCATIONS .....	304	
CROSSTALK .....	91	
REFERENCE SHEET .....	136	
INDUSTRIAL CONTROL .....	150	
TUBES AT WORK.....	212	
ELECTRON ART .....	252	
NEWS OF THE INDUSTRY.....	304	
NEW PRODUCTS .....	374	
NEW BOOKS .....	421	
BACKTALK .....	426	
INDEX TO ADVERTISERS .....	437	

**KEITH HENNEY**, Editor; **W. W. MacDonald**, Managing Editor; **John Markus**, Associate Editor; **Vin Zeluff**, Associate Editor; Assistant Editors—**Frank Haylock**, **Frank Rockett**, **J. M. Heron**, **M. L. Matthey**, and **J. E. Grolimund**; **G. T. Montgomery**, Washington Editor; **Donald G. Fink** (on leave); **Harry Phillips**, Art Director

**H. W. MATEER**, Publisher; **J. E. Blackburn, Jr.**, Director of Circulation, *Electronics*; **Wallace B. Blood**, Manager

**DISTRICT MANAGERS**, **D. H. Miller**, **H. R. Denmead, Jr.**, New York; **R. H. Flynn**, New England; **F. P. Coyle**, **R. E. Miller**, Philadelphia; **C. D. Wardner**, **A. F. Tischer**, **R. A. Werth**, Chicago; **E. J. Smith**, **J. L. Phillips**, Cleveland

Contents Copyright, 1945, by McGraw-Hill Publishing Company, Inc.

All Rights Reserved

McGRAW-HILL PUBLISHING COMPANY, INCORPORATED

JAMES H. MCGRAW, Founder and Honorary Chairman

PUBLICATION OFFICE 99-129 North Broadway, Albany, N. Y., U. S. A.

EDITORIAL AND EXECUTIVE OFFICES 330 West 42nd St., New York 18, N. Y., U. S. A.

James H. McGraw, Jr., President; Curtis W. McGraw, Senior Vice-President and Treasurer; Howard Ehrlich, Vice-President (for business operations); Willard Chevallier, Vice-President (for editorial operations); Joseph A. Gerardi, Secretary; and J. E. Blackburn, Jr., Director of Circulation.

ELECTRONICS, August, 1945, Vol. 18; No. 8. Published monthly, price 50c a copy. June Directory Issue \$1.00. Allow at least 10 days for change of address. All communications about subscriptions should be addressed to the Director of Circulation, 330 W. 42nd St., New York 18, N. Y.

Subscription rates—United States and possessions, Mexico, Central and South American countries, \$8.00 a

year, \$8.00 for two years, \$10 for three years. Canada (Canadian funds accepted) \$5.50 a year, \$9.00 for two years, \$11.00 for three years. Great Britain and British Possessions, 42 shillings for one year, 84 shillings for three years. All other countries \$7.00 for one year, \$14.00 for three years. Please indicate position and company connection on all subscription orders. Entered as Second Class matter August 29, 1936, at Post Office, Albany, New York, under the Act of March 3, 1879. BRANCH OFFICES: 520 North Michigan Avenue, Chicago 11, Ill.; 68 Post Street, San Francisco 4; Aldwych House, Aldwych, London, W.C. 2; Washington, D. C. 4; Philadelphia 2; Cleveland 15; Detroit 26; St. Louis 8; Boston 18; Atlanta 3, Ga.; 821 So. Hope St., Los Angeles 14; 58-9 Oliver Building, Pittsburgh 22.

## CHANGE OF ADDRESS

Director of Circulation,  
ELECTRONICS,  
330 West 42nd Street  
New York 18, N. Y.

Please change the address of my *Electronics* subscription.

Name .....

Old Address .....

New Address .....

New Company Connection .....

New Title or Position .....



## WHAT ARE YOUR TRANSFORMER PROBLEMS?

### IS IT QUANTITY?

UTC, the largest supplier of transformers to the electronic industry, is in a strong position to meet your requirements for postwar applications — radio, communications, FM, Television, electro-medical, etc.

### IS IT QUALITY?

UTC, in the collective opinion of critical users, is the "leader in the field" for units of lasting dependability. Incidentally, our Varick Street Plant is now running 98% hermetic sealing components.

### IS IT DESIGN?

UTC, known for pioneering efforts, manufactures a range of designs from the smallest transformers in the world to 50,000 ampere current transformers and complex filters.

### IS IT PRICE?

UTC, because of ingenious production methods, can give you a reliable product at a competitive price . . . war or postwar. And we can deliver now.

*United Transformer Corp.*  
150 VARICK STREET  
EXPORT DIVISION: 13 EAST 40th STREET,  
NEW YORK 13, N. Y.  
NEW YORK 16, N. Y., CABLES: "ARLAB"



ALL PLANTS

**A**S the draftsman's pencil makes its mark, he issues orders, through a remarkable kind of shorthand, to the men who must act on his drawings. But only with special assistance can human hands shape such precise, complex orders as these. No wonder the draftsman chooses his instruments with care...he is, in effect, taking them into partnership!

In this sense, Keuffel & Esser Co. drafting equipment and materials have been the draftsman's partners for 78 years in creating the peaceful culture and wartime might of America, in making possible our concrete dams, steel bridges, aluminum bombers.

## partners in creating

So universally is this equipment used, it is self-evident that every engineering project of any magnitude has been built with the help of K & E. Could you wish surer guidance than this in the selection of your "drafting partners"?

Especially in these hurried days, you will find a PARAGON\* Drafting Machine a boon to your work...and your nerves! With the finger tips of your left hand on its control ring, the lightest pressure enables you to set the scales at any angle, anywhere on the board. Your right hand is always free. For the full PARAGON\* story, write on your letterhead to Keuffel & Esser Co., Hoboken, N. J.

\*Reg. U. S. Pat. Off.

**KEUFFEL & ESSER CO.**

EST. 1867

NEW YORK · HOBOKEN, N. J.

CHICAGO · ST. LOUIS · DETROIT · SAN FRANCISCO  
LOS ANGELES · MONTREAL



...the world's highest dams



....longest bridges



....fastest airplanes



*Drafting, Reproduction, Surveying  
Equipment and Materials.  
Slide Rules, Measuring Tapes.*

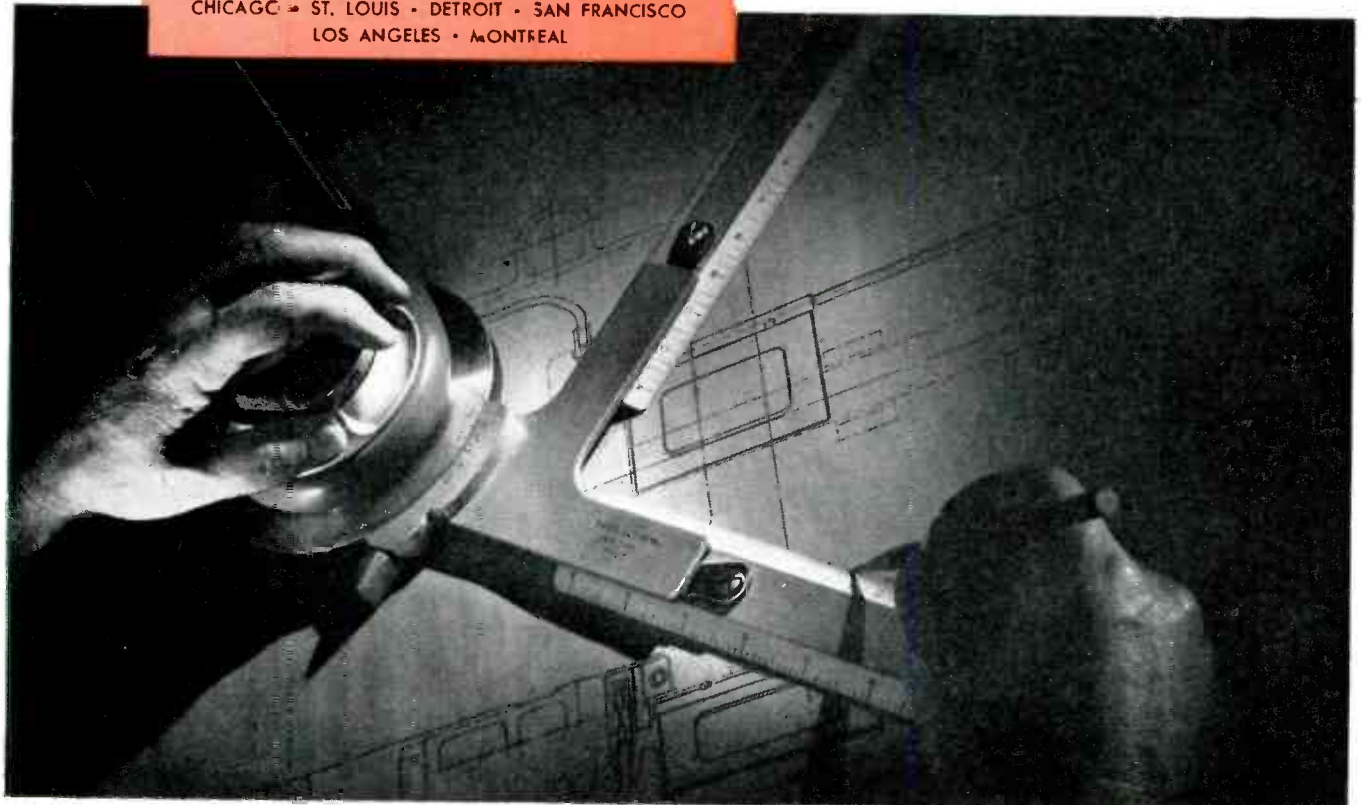

# A PIPE DREAM

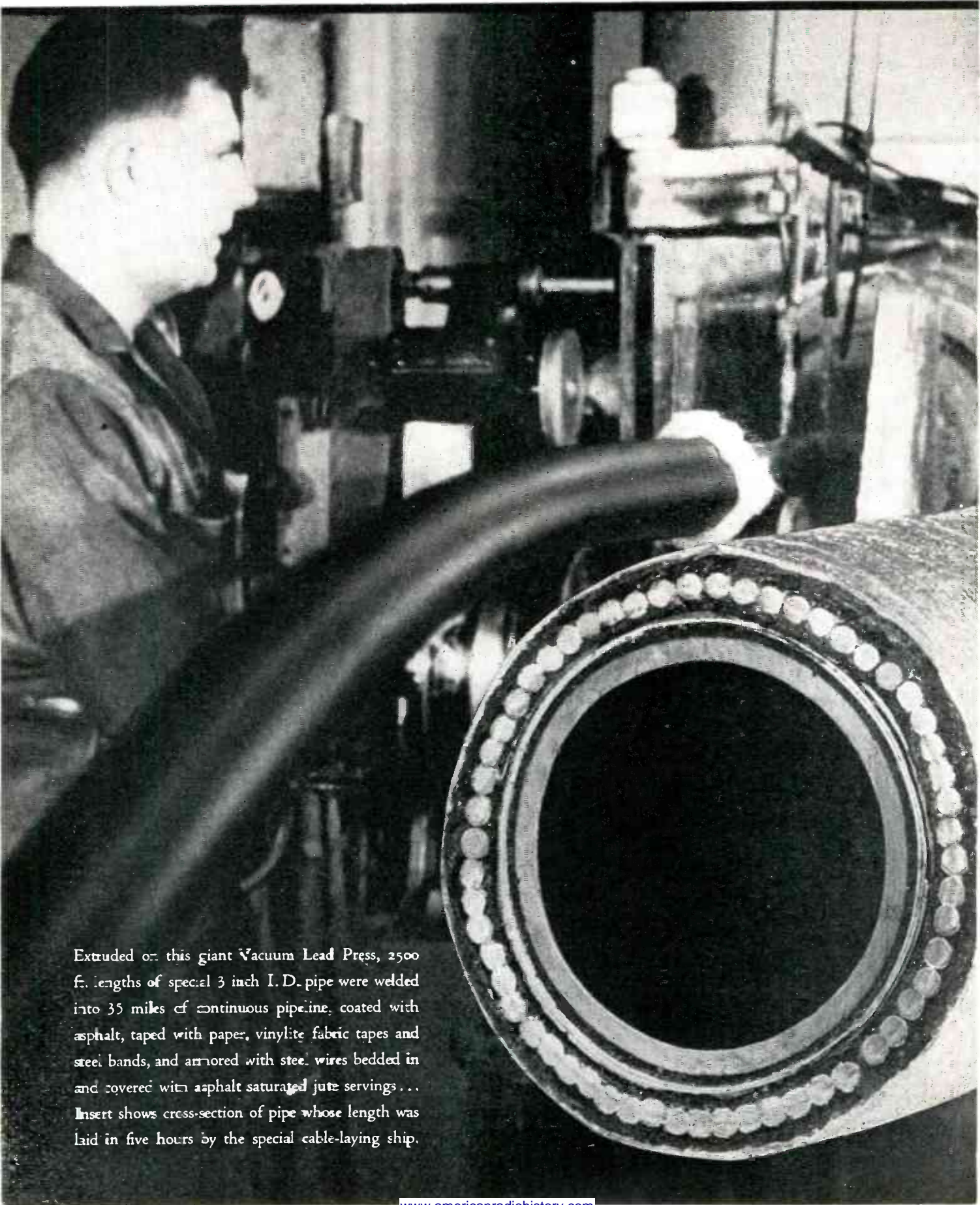

Extruded on this giant Vacuum Lead Press, 2500 ft. lengths of special 3 inch I. D. pipe were welded into 35 miles of continuous pipeline, coated with asphalt, taped with paper, vinylite fabric tapes and steel bands, and armored with steel wires bedded in and covered with asphalt saturated jute servings... Insert shows cross-section of pipe whose length was laid in five hours by the special cable-laying ship.

# COME TRUE...

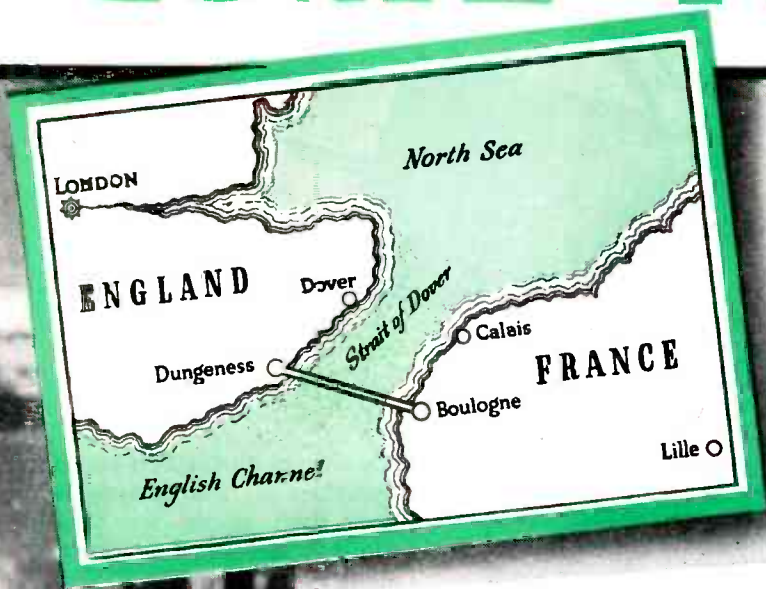

With the active interest of General Eisenhower, and Allied officers, Admiral Lord Louis Mountbatten conceived a series of pipelines under the English Channel to feed precious oil and gasoline to Allied fighting forces speeding across France, Belgium, Luxembourg and Germany.

Experience in making the largest submarine electric-power cables enabled General Cable to volunteer undertaking its part of this important contract with its own existing facilities. General Cable quickly started making this continuous 35-mile pipe, thanks to available equipment commandeered from its coast-to-coast plants, its wealth of research and engineering talent, plus dogged determination to speed Victory. In about nine months from installation, the under sea traffic fuel from England to the continent via channel pipelines had totalled 120,000,000 gallons, freeing oil tankers, cars and other transport for more vital duties. With public recording of this secret comes the buoyant feeling that dreams do come true and many more, as yet unrevealed, will foster progress in a peace we all can share.

## GENERAL CABLE CORPORATION

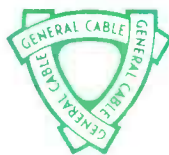

*General Cable Corporation Sales Offices are located at Atlanta, Boston, Buffalo, Chicago, Cincinnati, Cleveland, Dallas, Detroit, Houston, Kansas City (Mo.), Los Angeles, New York, Philadelphia, Pittsburgh, Rome (N.Y.), St. Louis, San Francisco, Seattle, Washington (D. C.)*

# Capacity



... to deliver molded oil-paper capacitors . . . in quantities more than ample for your needs . . . and in exact agreement with American War Standard C75/221 . . . is afforded by batteries of these dual-77-cavity monsters. Fed with oil-impregnated, aluminum-foil-wound, non-inductive sections and pre-forms of mica-filled phenolic, these huge presses are continually pouring forth capacitors of uniformly high quality with the consistency of characteristics for which Tobe products are famous.

So, however great may be your consumption of molded oil-paper capacitors, Tobe can deliver them in volume. Capacitance ranging from 1000 to 50,000 mmfd; working voltages from 120 to 800 volts d-c; shunt resistance as high as 40,000 megohms at 25°C; power factor as low as 0.004 at 1000 cycles; and moisture seal that meets all thermal cycle, immersion, and humidity requirements.

Modern, large capacity equipment, skillfully operated and carefully supervised, assures quantity with quality.



FIELD OFFICES IN NEW YORK CITY • CHICAGO • DETROIT • GLENDALE, CALIFORNIA



**NOW** . . . **SEALING—WELDING—BONDING**



The THERMATRON "Weldmaster" with demonstration heat-weld equipment.

MORE PROVED USES FOR THE

**Thermatron**

**ELECTRONIC DIELECTRIC  
HEAT GENERATOR**

Electronic welding of thermoplastic sheeting such as Koroseal, Vinylite and Saran, which has been proved practical and time-saving by months of production on THERMATRON units in a war industry, opens a new field for postwar activities.

The list of everyday products which lend themselves to the THERMATRON method is endless. It includes such items as shower curtains, bathing caps, aprons, cosmetic bags, tobacco pouches, tennis racket covers, etc.—in fact, almost any product fabricated of thermoplastic sheeting which has hitherto been stitched or sealed by resistance heating. THERMATRON can handle the assignment—and make faster and cheaper "seals" or "welds."

Almost any seamed product of thermoplastic sheeting can be fabricated better and quicker with THERMATRON equipment.

**Thermatron** electronic dielectric welders are available in 1 KW, 2½ KW and 5 KW sizes. Send for folder, "Heat Sealing of Plastics by Electronics."

### THE **Thermatron** LINE

. . . of electronic dielectric heat generators, 500 watts to 30 kilowatts, for all purposes, including the popular 5 KW "Heatmaster" especially designed for heating preforms, is described in our THERMATRON folder. Free on request.

No THERMATRON has ever become an orphan.  
THERMATRON application service insures against it.

**Thermatron** ratings based on output.



**RADIO RECEPTOR COMPANY, Inc.**  
251 WEST 19th STREET  
NEW YORK 11, N. Y.

Engineers and Manufacturers of Airway and Airport Radio Equipment  
SINCE 1922 IN RADIO AND ELECTRONICS



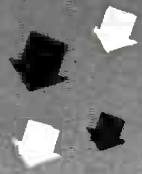

# RIGHT

from the start...

Because every detail was painstakingly worked out in the early stages of development, this Narrow Band (200 cycles) FM Modulator-Oscillator unit is doing superb wartime service and will be a boon to postwar communications. Let us help you solve your postwar problems.

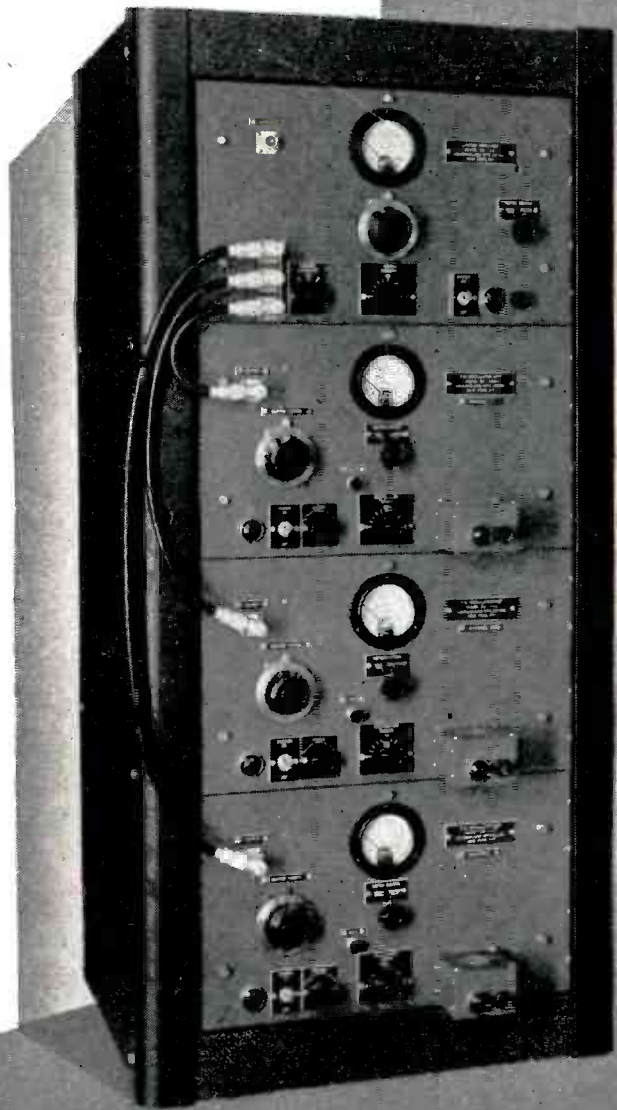

# HAMMARLUND

THE HAMMARLUND MFG. CO., INC., 460 W. 34<sup>TH</sup> ST., NEW YORK 1, N. Y.  
MANUFACTURERS OF PRECISION COMMUNICATIONS EQUIPMENT

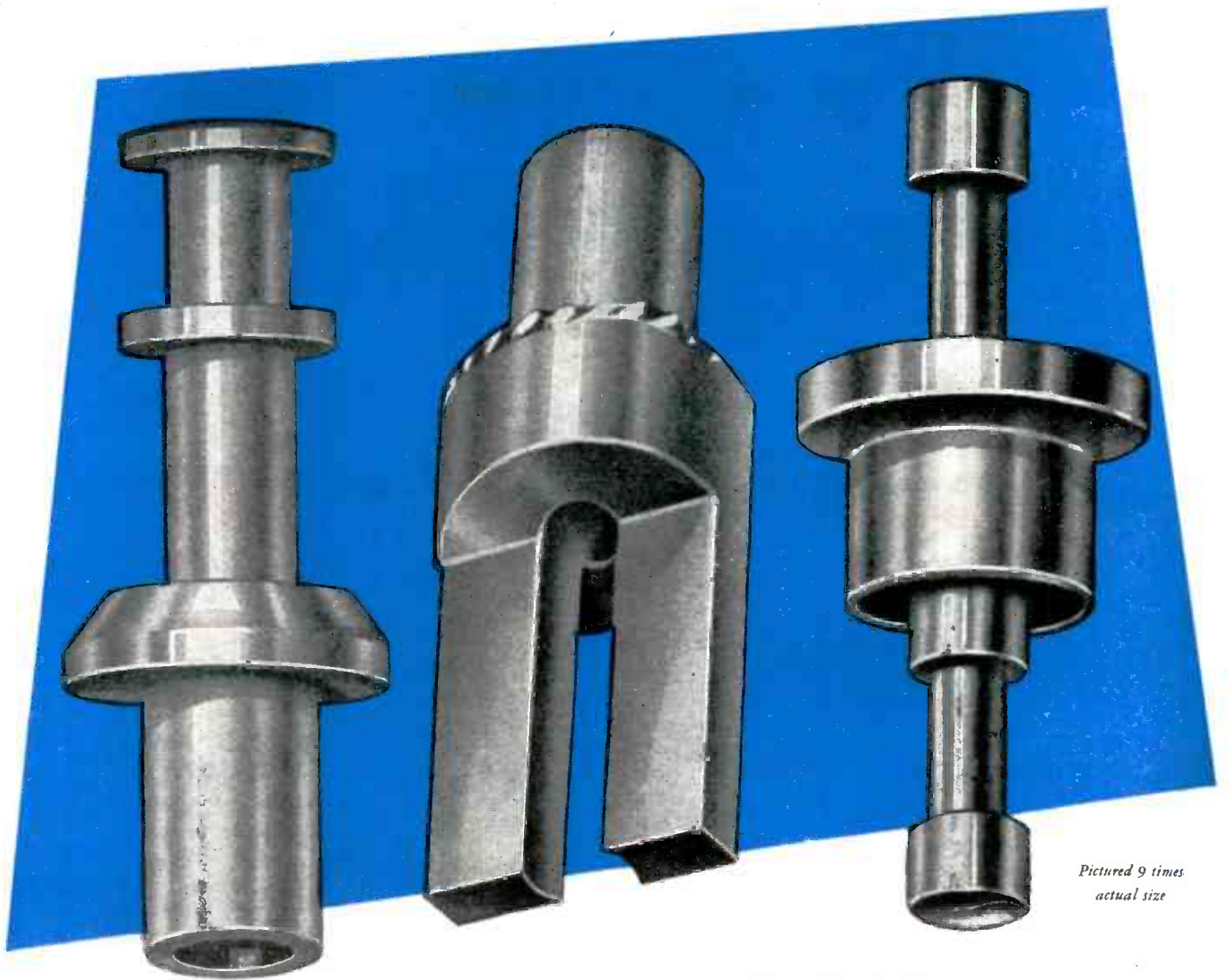

*Pictured 9 times  
actual size*

## MEET THREE "BIG" LUGS

Reading from left to right they are C.T.C.'s Turret Terminal Lug, C.T.C.'s Split Terminal Lug and C.T.C.'s Double End Terminal Lug and we're willing to wager that once you've made their acquaintance you'll be very glad you've joined their ever-widening circle of friends who find in them a better, faster, more economical way to get firm, quick soldering terminal posts.

*C.T.C. TURRET TERMINAL LUGS* are firmly anchored to terminal boards by a

simple swaging operation. Two soldering spaces permit two or more connections without superimposing wires — insure good contact, neat appearance. Made of brass, heavily silver plated, to fit  $1/32''$ ,  $2/32''$ ,  $3/32''$ ,  $4/32''$ ,  $6/32''$  and  $8/32''$  terminal board thicknesses.

*C.T.C. SPLIT TERMINAL LUGS* have a  $.050''$  hole through their shaft which makes them ideal for use on transformers or other potted units that require soldering after potting and on terminal boards

that should be wired from top or bottom side of board without drilling. Made of heavily silver plated brass to fit  $3/32''$  terminal boards.

*C.T.C. DOUBLE END TERMINAL LUGS* provide twin terminal posts in one simple swaging operation. They may be wired from top or bottom and electrical connection is perfect because both posts are part of the same lug. Stocked in  $3/32''$  terminal board thicknesses.



**THE NEW C.T.C. CATALOG NO. 100** contains complete information on C. T. C. LUGS, *All-Set* TERMINAL BOARDS, SWAGING TOOLS, X-RAY ORIENTED CRYSTALS and I-F TRANSFORMERS. Get your free copy.



**CAMBRIDGE THERMIONIC CORPORATION**  
439 Concord Avenue • Cambridge 38, Mass.



## SPECIALIZED FRACTIONAL H. P. MOTORS



**MODEL J31A**  
(for high ambient temperatures)  
400 Cycles, 115 Volts.  
1/100 H.P. Weight 15 oz.  
Diameter  $1\frac{15}{16}$ ".  
Length  $2\frac{29}{32}$ ".



**MODEL J31**  
(for general applications)  
400 Cycles, 115 Volts,  
1/50 H.P. Weight 15 oz.  
Diameter  $1\frac{15}{16}$ ". Length  
 $2\frac{29}{32}$ ".



### MODELS J36 AND J36A

Voltage Generator,  
Weight 20 oz. Length  
3". Diameter  $2\frac{1}{4}$ ". Out-  
put voltage is linear  
with speed to within  
 $\pm 1\%$  and voltages are  
equal with  $\pm 1\%$  of  
rotation.

J36—From Zero to 5000 R.P.M.  
J36A—under 200 R.P.M.



**MODEL J31B**  
400 to 1200 Cycles  
variable frequency 115  
Volts. 15 oz. Diameter  
 $1\frac{15}{16}$ ". Length  $2\frac{29}{32}$ ".



### MODELS J49 AND J49A

115 Volts, 1/250 H.P.  
Weight 16 oz. Diameter  
 $1\frac{3}{4}$ ". Length  $2\frac{11}{16}$ ".

J49—60 Cycles  
J49A—400 Cycles



**MODEL J61**  
28 Volts D.C. Torque  
unit. Develops 5 oz. in.  
throughout 90° swing.  
Diameter  $1\frac{3}{4}$ ". Length  
 $2\frac{11}{16}$ ".

## CENTRIFUGAL BLOWER UNITS

### MODEL J-50 BLOWER UNIT

60 CYCLES  
115 VOLTS

Delivers 10 cu. ft. per minute of free air.  
Weight 21.5 oz. Overall diameter  $3\frac{11}{16}$ ".  
Overall length  $4\frac{1}{16}$ ".

- MODEL J51 — 400 CYCLES, 115 VOLTS. Delivers 22 cu. ft. per min. of free air. Weight: 21.5 oz., Diameter  $3\frac{11}{16}$ ", Length  $4\frac{9}{32}$ ".
- MODEL J52 — 400 TO 1800 CYCLES VARIABLE FREQUENCY. 115 Volts. Delivers 17 cu. ft. per min. of free air. Diameter  $3\frac{11}{16}$ ". Length  $4\frac{1}{16}$ ".
- MODEL J53 — 28 VOLTS D.C. Delivers 22 C.F.M.
- MODEL J54 (Midget)—60 CYCLES, 115 VOLTS Delivers 6 C.F.M.
- MODEL J55 (Midget)—400 CYCLES, 115 VOLTS. Delivers 13 C.F.M.



## EASTERN AIR DEVICES, INC.

An Affiliate of The Fred Goat Co., Inc., Est. 1893  
585 DEAN STREET, BROOKLYN 17, N. Y.

*it's here*



# MANUAL OF INDUSTRIAL ELECTRONIC TUBES

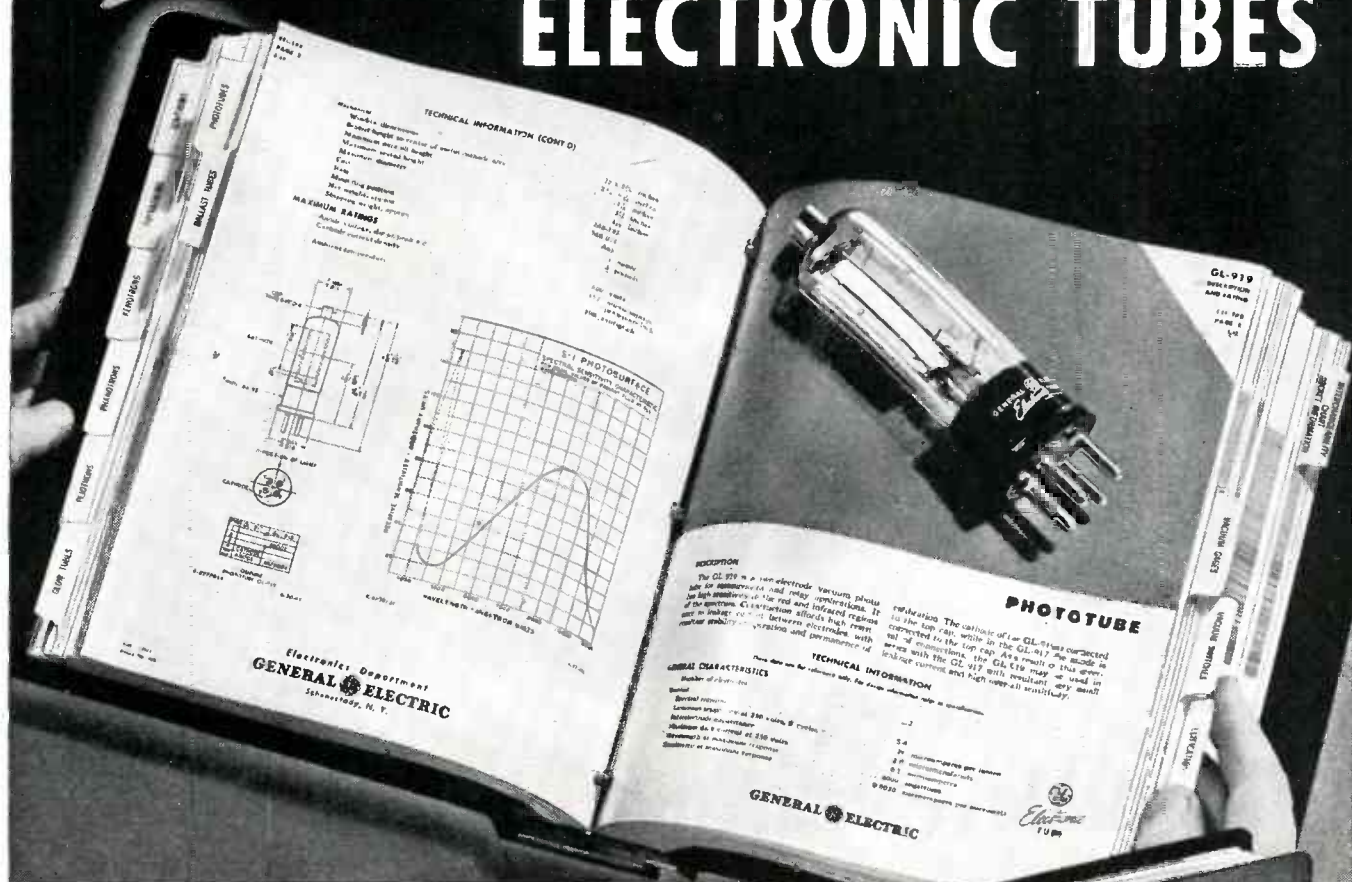

## Newest, most comprehensive book in its field!

**OVER 400 LARGE PAGES**, filled with photographs, outline drawings, and performance curves, make G.E.'s new, *complete* manual on electronic tubes for industry a "must" for engineers and management.

**EVERY TYPE OF INDUSTRIAL TUBE** has its section — ignitrons, thyratrons, kenotrons, pliotrons, phanotrons, phototubes, glow tubes, ballast tubes, vacuum gages and switches. Applications are explained, typical circuits given, and 93 tubes are pictured, described, and rated. New tubes, such as the midjet thyatron, are included.

**DESIGNERS OF ELECTRONIC EQUIPMENT** will find this manual a working ally they cannot do without. To users of industrial tubes, the book is a time-saving reference work of great value—easy to consult because of the tabbed dividers and indexed page corners, always up-to-date by reason of its loose-leaf format with new sheets sent when changes occur.

**HANDSOMELY AND DURABLY BOUND**, G.E.'s new tube manual is indispensable for your desk, file, or engineering library. Order direct from *Electronics Dept. (Section 1C), General Electric, Schenectady 5, N. Y.*

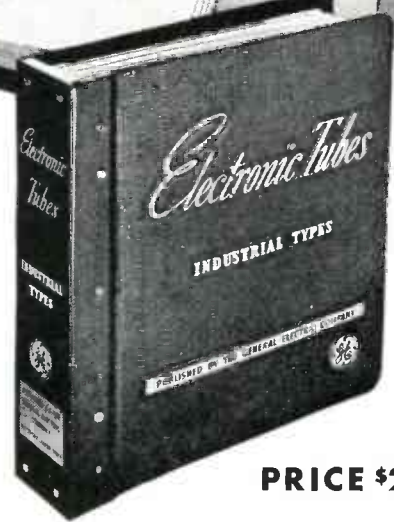

**PRICE \$2**

"Electronic Tubes, Industrial Types" comes to you for \$2. Also, for an annual service charge of \$1 new and revised pages will be sent to you regularly as issued... **ORDER TODAY**, enclosing payment, or giving authority on your company letterhead to invoice you.

# GENERAL ELECTRIC

142-D15-8850

TRANSMITTING, RECEIVING, INDUSTRIAL, SPECIAL PURPOSE TUBES • VACUUM SWITCHES AND CAPACITORS



# 100,000 watts

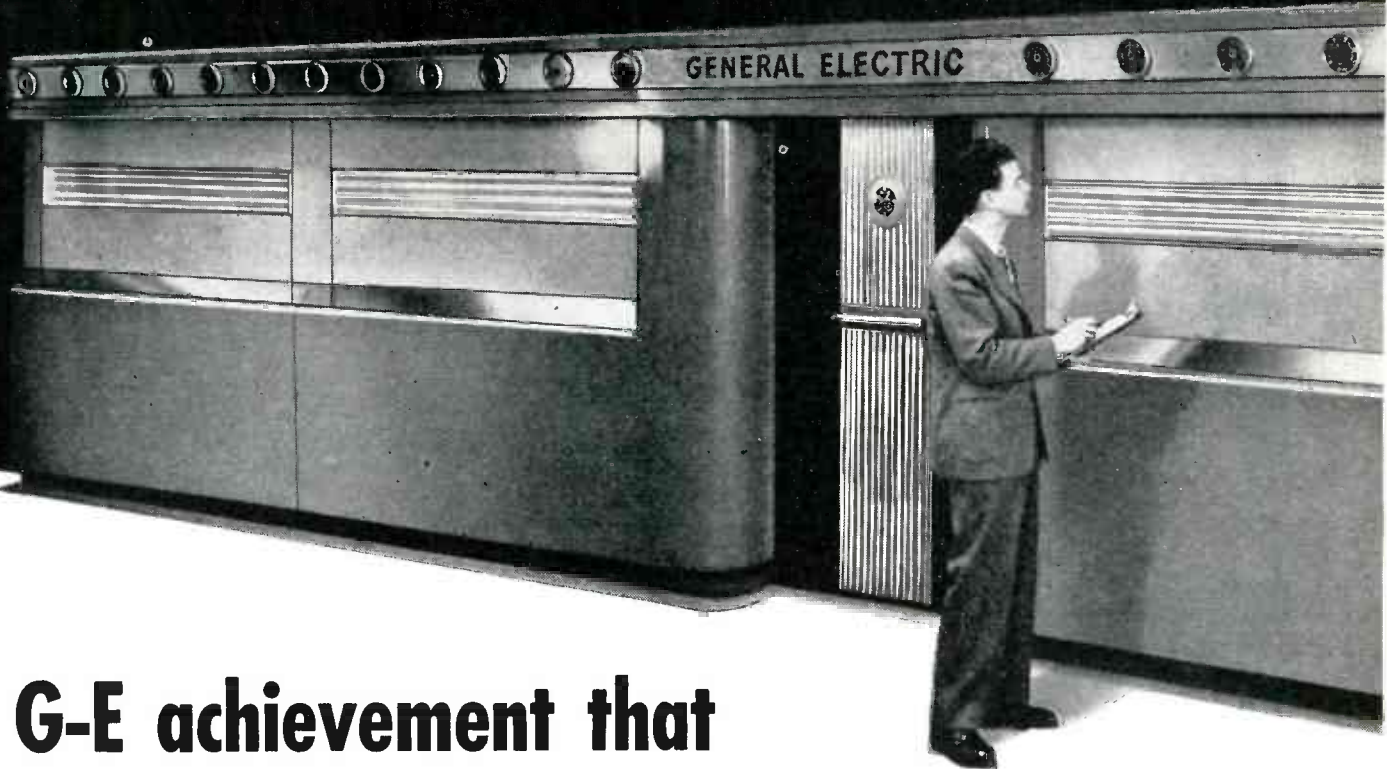

## A G-E achievement that sets the pace for broadcast transmitters

GENERAL ELECTRIC'S new 100-kilowatt international transmitters establish the pattern for G-E AM broadcast equipment—equipment which will include all the basic refinements of modern broadcasting.

• Whether your AM broadcast requirements are for domestic or international service, General Electric will be able to supply broadcast equipment for every need—AM transmitters from 250 watts to 1000 kilowatts,

complete studio equipment, auxiliary electrical components, and antenna systems. This equipment will be designed to give you maximum performance. It will be capable of delivering high-quality transmissions over sustained periods of time—with maximum freedom from outages. It will be engineered ahead of tomorrow's needs to insure your investment against rapid depreciation.

• General Electric has rich experi-

ence in developing and building radio and electrical equipment of every type. General Electric operates the world's largest broadcast equipment proving ground for the four major services—AM, FM, television, and international broadcasting.

• For information on G-E equipment, call your G-E broadcast equipment representative at once, or write: *Electronics Department, General Electric, Schenectady 5, N. Y.*

STUDIO AND STATION EQUIPMENT • TRANSMITTERS

# GENERAL ELECTRIC

160-D5-6914

# of AM power



## Establish a priority on delivery of your **AM** equipment—*now!*

Write for your copy of the "G-E Equipment Reservation Plan" which explains General Electric's plan to help you obtain early delivery of G-E AM transmitters and associated equipment.

Use G-E Electronic Tubes in your station for maximum dependability, finer performance.

Hear the G-E radio programs: "The World Today", news, Monday through Friday 6:45 p. m., EWT, CBS. "The G-E All-Girl Orchestra," Sunday 10 p. m., EWT, NBC. "The G-E House Party," Monday through Friday, 4 p. m., EWT, CBS.

ANTENNAS • ELECTRONIC TUBES • HOME RECEIVERS

**AM • TELEVISION • FM**

*See G.E. for all three!*



# Most popular transmitting tube



## TYPE GL-807 Beam Power Amplifier . \$1.95

High-vacuum, 4-electrode, beam-power-amplifier tube, with heater-type filament. Filament voltage and current, 6.3 v and 0.90 amp. Max plate ratings (CCS) are: voltage 600 v, current 0.10 amp; input 60 w, dissipation 25 w. Max plate ratings (ICAS) are: voltage 750 v, current 0.10 amp; input 75 w, dissipation 30 w. Frequency at max ratings 60 megacycles; at reduced ratings 125 megacycles. Gm 6,000.

**E**VERY type of transmitter uses this versatile Type GL-807 G-E tube—broadcasting, communications, police, amateur. The tube is employed as a power amplifier in smaller sets; large trans-

mitters use it for service in their low-power stages.

Continuous improvement has enabled Type GL-807 to meet the ever more rigid requirements of the armed forces. Especially is this true of the screen current limits, which now are lower than before. As a result, the commercial usefulness of the tube and its application-range are further broadened.

Basic ratings above give evidence of Type GL-807's adaptability to transmitter service of varying types. A low price of \$1.95 reflects economies that stem from wide demand and large-scale factory output. For complete ratings and performance data see your nearest G-E office or distributor, or write to *Electronics Department, General Electric, Schenectady 5, N. Y.*

*When amateur tubes again are available in quantities, General Electric will offer a complete line meeting every requirement.*

# GENERAL ELECTRIC

161-D6-0000

TRANSMITTING, RECEIVING, INDUSTRIAL, SPECIAL PURPOSE  
TUBES • VACUUM SWITCHES AND CAPACITORS

August 1945 — ELECTRONICS



Where **SPACE** and **PERFORMANCE** are Vital  
**DUMONT OFFERS . . . .**

*The* **TINYMITE**

**SMALLEST PAPER CAPACITOR . . . .**  
*yet 100%*  
**MOISTUREPROOF**

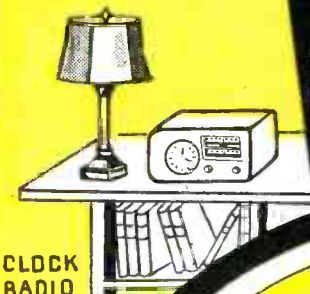
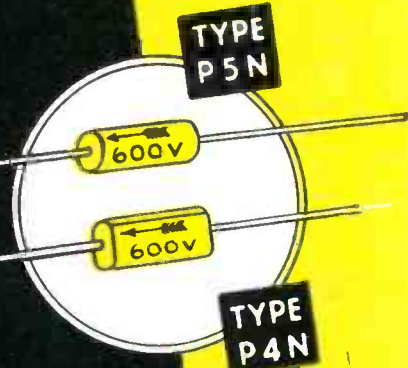

**CLOCK RADIO**

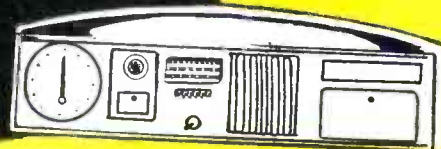

**AUTO RADIOS**

**FEATURES**

1. Bakelite Resinoid Ends. Lead wire cannot pull out, even under hot conditions.
2. Non-Inductive.
3. Excellent Temperature Coefficient.
4. Very high leakage Resistance.
5. Fine Power-Factor.
6. Range from 20 MMFD to .25 MFD.  
From 150 volts to 600 volts.
7. Types P4M, P5N for 100% humidity operation.
8. Types P4, P5 for 95% humidity operation.

*Samples and price list on request*

PAT.  
PEND.

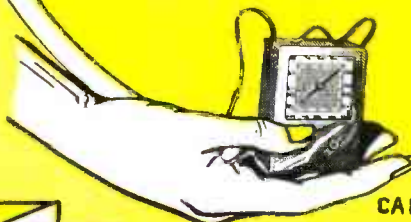

**CARRYING RADIOS**



**HEARING AIDS**

**DUMONT ELECTRIC CO.**  
MFRS OF  
CAPACITORS FOR EVERY REQUIREMENT  
34 HUBERT STREET NEW YORK, N. Y.

**BUY EXTRA WAR BONDS . . . . 'TILL THE WAR IS OVER**

Aircraft Stresses in Giant Wind Tunnels Registered Through

# CLARE "Custom-Built" RELAYS

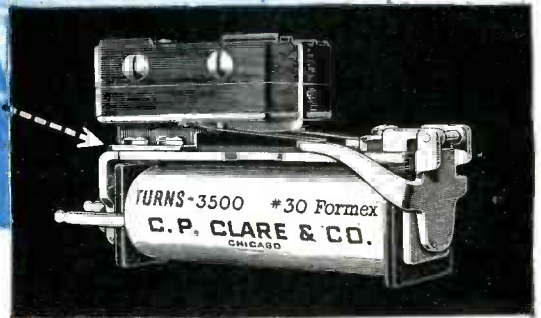
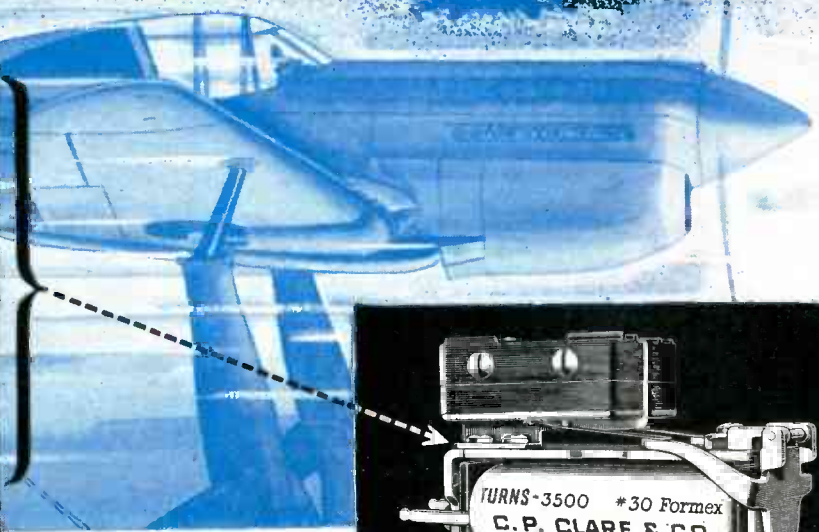
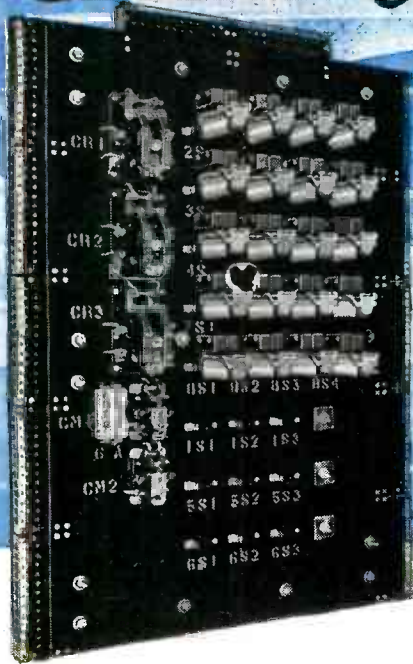

CLARE "Custom-Built" TYPE "AMS" RELAY

● Twenty-nine Clare "Custom-Built" Type "AMS" Relays are used in this control panel, manufactured by the Toledo Scale Company of Toledo, Ohio, to register the effects of wind pressure on aircraft in giant wind tunnels.

Having used Clare "Custom-Built" Relays for a number of years as components of their sensitive automatic weighing machines, the Toledo Scale Company did not hesitate to pick Clare Relays for this highly specialized aircraft testing equipment.

The Clare Type "AMS" which is used in this application has the same characteristics as the Clare Type "A" a.c. Relay except that enclosed snap-action switch contacts are provided. These contacts have a high current rating and make a relay for sensitive operation with heavy duty contacts. A maximum of two switches may be mounted on one relay.

This application of Clare "Custom-Built" Relays to operate delicate and highly specialized controls is typical of the way in which engineers and designers are making use of the Clare principle of "custom-building" to obtain just the relay for the specific job.

Clare Relays offer the designer the widest possible selection of contact ratings, innumerable combinations of contact forms, flat or hemispherical contacts of rare metals or special alloys, coil windings to match the circuit and application.

Submit your relay problem to Clare. Let our engineers work with you in developing a Clare "Custom-Built" Relay that will exactly meet your requirements. Send for the Clare catalog and data book. Address C. P. Clare & Co., 4719 West Sunnyside Avenue, Chicago 30, Illinois. Sales engineers in all principal cities. Cable address: CLARELAY.



Armature bearing consists of a stainless steel bearing pin operating in an oil impregnated yoke insert.

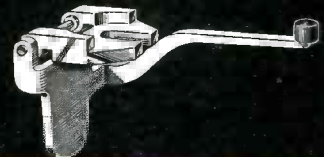

Coil core of Type "A" Relay is of laminated silicon steel with a slot at the armature end. Copper shading rings eliminate chatter.



Coils are wound with special heavy insulated wire which avoids the possibility of short circuited turns. Coils are impregnated to insure quiet operation.



# CLARE RELAYS

"Custom-Built" Multiple Contact Relays for Electrical, Electronic and Industrial Use

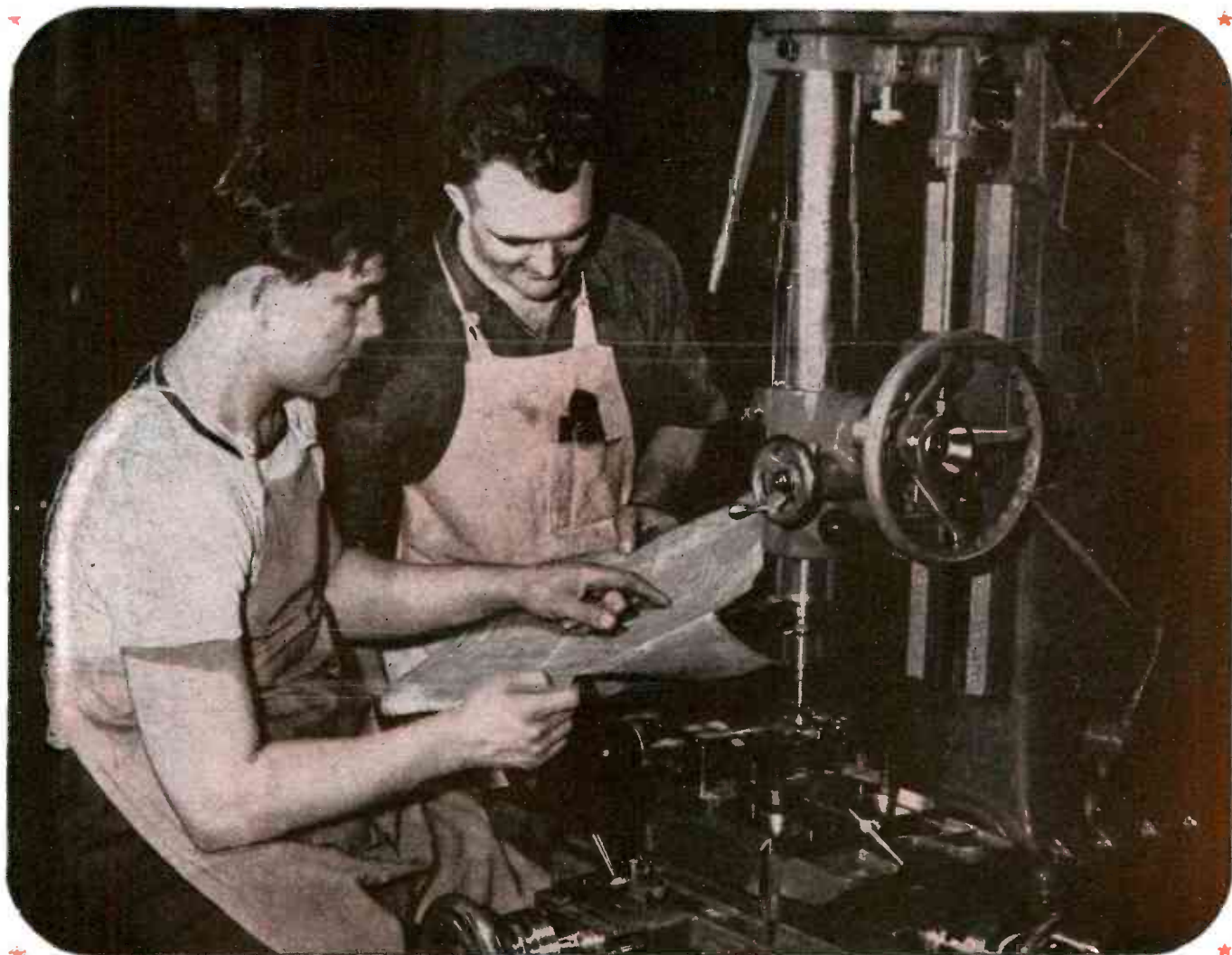

*One of these Days* **THEY'LL BE WORKING**  
**TO A DIFFERENT SET OF BLUEPRINTS**

*At your Service . . .*

**ALLEGHENY LUDLUM'S  
 FILM LIBRARY**

Instructional films on tool and stainless steels—some in full color, all with sound—available for free showings by companies, trade & industrial groups, student training courses, technical schools and colleges, etc., upon request.

**WRITE FOR DETAILS**  
 ADDRESS DEPT. E-34

A GREAT many companies—yours probably included—already have a clear idea what items those new blueprints will cover. One thing's sure: whether your future products stay in familiar fields or enter new markets, they'll have to be as modern and value-packed as your engineers can make them. Improved design, and the use of better materials, are the means to the end.

You'll find a lot of your "better materials" answers among the various Allegheny Ludlum families of special, high-alloy steels. If you're looking for such qualities as improved electrical characteristics,

finer appearance, greater strength, resistance to heat, wear or corrosion, etc., we have the design and production data you need. Let our Technical Staff help with your plans.



**Allegheny Ludlum**  
**STEEL CORPORATION**  
 GENERAL OFFICES: BRACKENRIDGE, PENNA.

W&D . . . B-9330

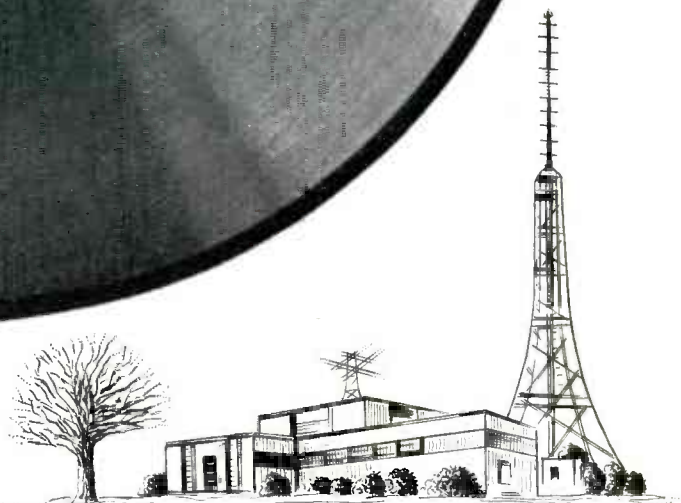
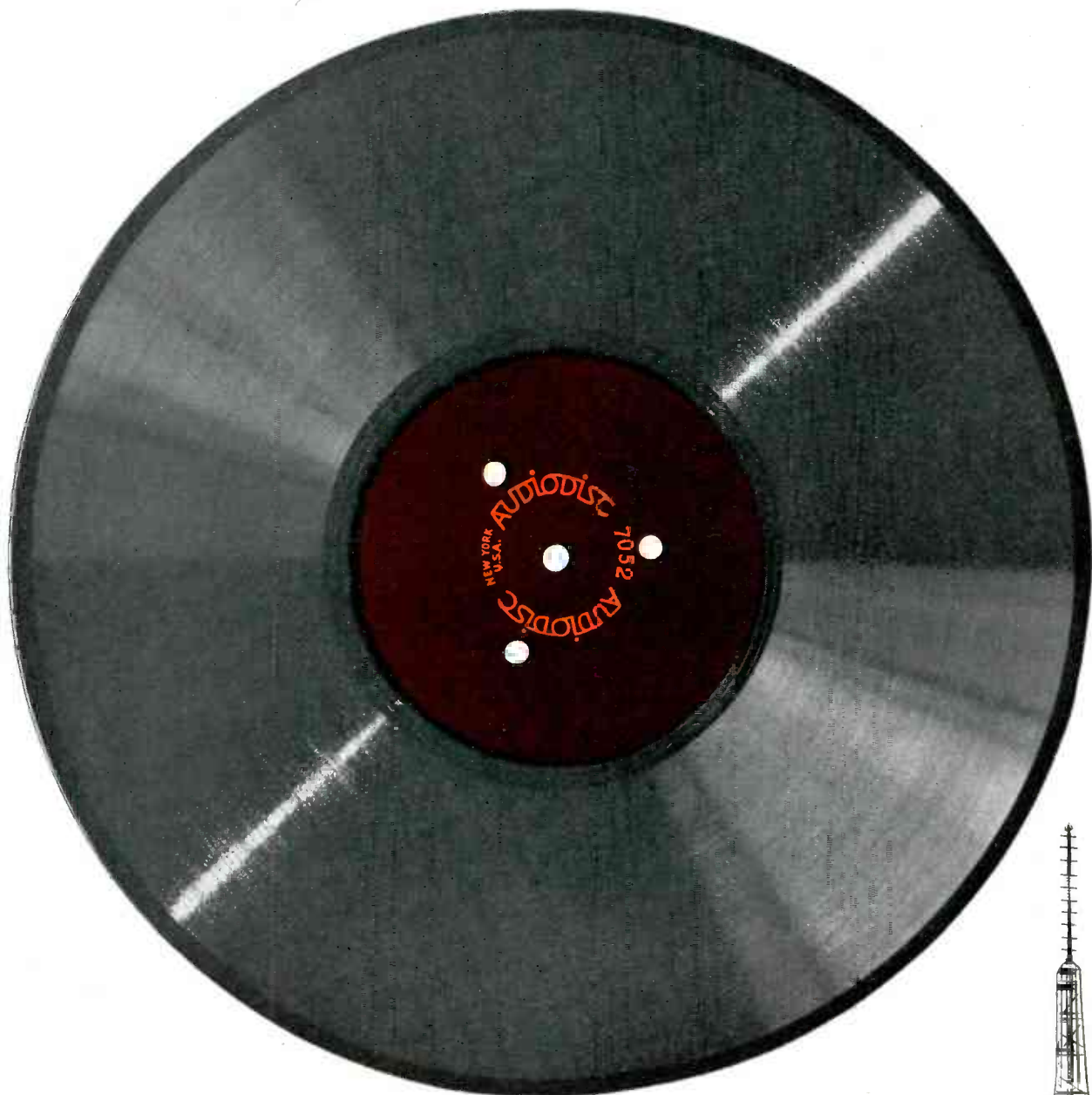

There are no finer recordings than those transcribed on

**audiodiscs**

AUDIO DEVICES INC. • 444 MADISON AVE., N. Y.



*they speak for themselves* **audiodiscs**

# Place your Electronic Problem before these Temco Engineers



Accomplished Radio and Electronic Engineers sit at this Temco Table and by combining their engineering and inventive abilities, they have produced numerous new electronic devices.

From Radar to Chronaximeters, they have designed and manufactured electronic equipment which reflects and incorporates great technical achievements. Backed by a very flexible and efficient manufacturing organization, they are one of the best equipped staffs of Engineers to consult regarding problems involving electronic equipment.

No matter how complicated your problem may appear, a Temco-engineered device can provide the answer. The Temco Table, therefore, is the best place for such problems. For proof, ask us to show you what we have accomplished for others. Write for facts today.

From left to right: S. L. Sack, J. C. Cardon, Morton Kahn, E. E. Baker, E. E. Horrocks, H. H. MacAdams

# TEMCO

**RADIO COMMUNICATION  
EQUIPMENT**

TRANSMITTER EQUIPMENT MFG. CO., INC.  
345 Hudson Street • New York 14, N. Y.

**HOW EXCELLENCE IS BUILT INTO**

# Sangamo

**MICA  
CAPACITORS**

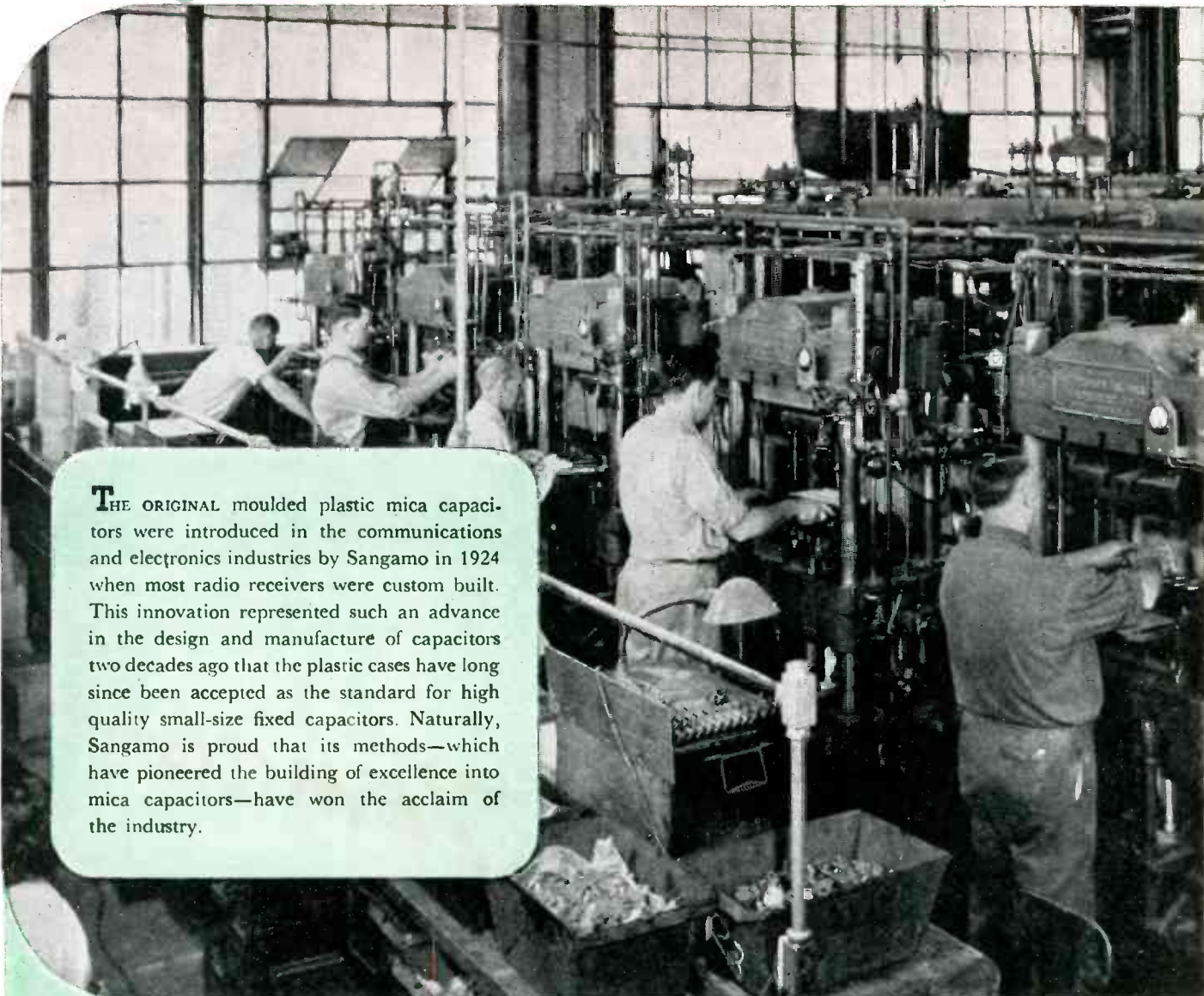

**T**HE ORIGINAL moulded plastic mica capacitors were introduced in the communications and electronics industries by Sangamo in 1924 when most radio receivers were custom built. This innovation represented such an advance in the design and manufacture of capacitors two decades ago that the plastic cases have long since been accepted as the standard for high quality small-size fixed capacitors. Naturally, Sangamo is proud that its methods—which have pioneered the building of excellence into mica capacitors—have won the acclaim of the industry.

*Moulding presses used in the production of Sangamo capacitors.*

**SANGAMO ELECTRIC**

ESTABLISHED 1898 • • • MICA CAPACITORS • • •

# Capacitor MOULDING

IN ORDER to insure the continued satisfactory operation of a mica capacitor, it is essential that the capacitor element be provided with a shell or housing of some sort. This housing not only serves to give the capacitor increased mechanical strength and, consequently, durability, but also serves to help prevent the absorption of moisture and to retain the desired characteristics built into the capacitor unit. Prior to about 1924, most mica capacitors were mechanically held by using two outside plates of fiber or other insulating material, which were riveted together to form a housing or protective case for the unit. This did not prevent the absorption of moisture. In 1924, Sangamo conceived the idea of moulding mica capacitor elements in plastic or bakelite cases, and this proved so satisfactory that this method of housing capacitors has been employed ever since. Mica capacitors are moulded in presses, where the proper operating temperatures and pressures insure uniform, thoroughly cured plastic enclosures. Highly polished dies result in a capacitor with a smooth, glossy finish which is moisture resistant. Various moulding compounds can be used in the production of mica capacitors, but those most commonly used are of the low loss mica filled types, which contribute to high insulation resistance and high "Q" values in the finished capacitor. The use of plastic housings contributes greatly to the excellence of the quality in Sangamo mica capacitors.

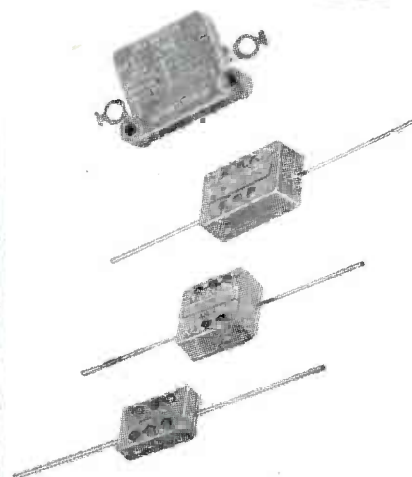
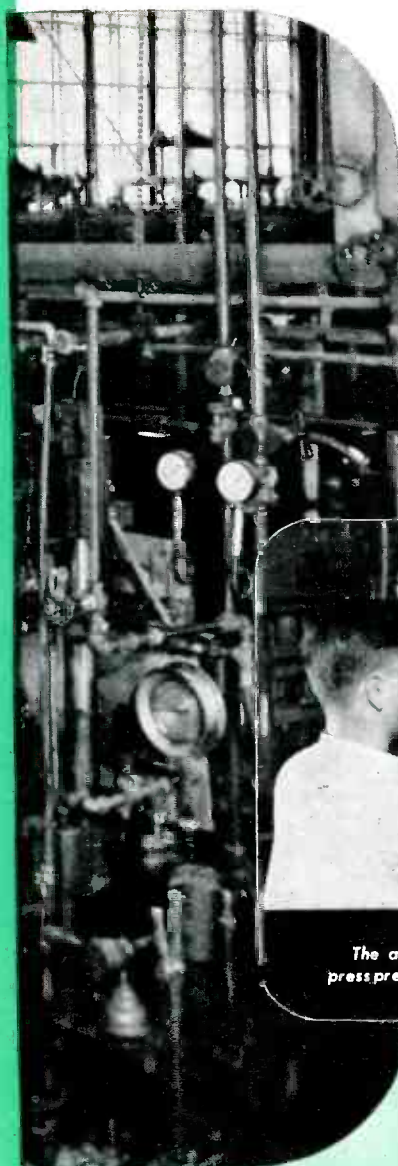
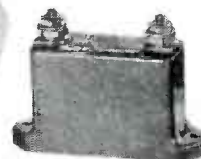

The above picture shows an operator loading the press preparatory to moulding Sangamo mica capacitors.

**COMPANY** **SPRINGFIELD**  
**ILLINOIS**

• • • WATT HOUR METERS • • • TIME SWITCHES • • •

# Announcing Allis-Chalmers

# ELECTRONIC

## Here's What it is:

**STURDY, Long-Life Oscillating Tube** — fully protected by overload relays, water filters and pressure switches.

**NEW Coupling System**, developed by A-C, keeps losses low, permits adaptation to most applications without use of radio frequency transformers.

**CHOKE COIL** protects rectifier tubes from damage by high-frequency radio currents.

**HEAVY-DUTY Transformer** for handling overloads, other extreme operating conditions.

**3-PHASE Rectifying System** obtains maximum power from electronic heater, prevents uneven load on power lines.

**INDIVIDUAL Filament Transformer** for each rectifier tube, easy to get at.

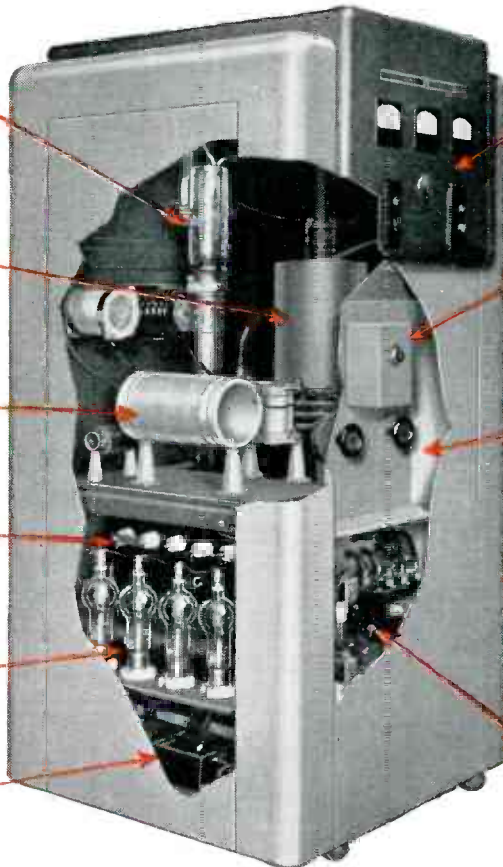

**LARGE Indicator Panel** for easy reading — shows at a glance when power is on, grid and plate currents, filament voltage.

**AUTOMATIC Timer** controls heat sequence from 2/10 seconds to 2 minutes, makes unit easy for unskilled operators to use.

**ALL Controls** on one panel for easy change in applications. No other internal adjustments needed. Protected from tampering by door and lock.

**MODERN Industrial Cabinet** encloses complete unit. All-Steel construction. Mounted on casters for mobility.

**SAFETY FEATURES:** Heavy-duty control, high water-temperature switch, fuses, interlocking switches on doors to protect operators.

*Pioneer Builders of Electronic Equipment for Industry.*

**Allis**





**Great, New....**

# HEATER

**ALL INDUCTION  
HEATERS  
ARE NOT ALIKE!**

Outstanding features of this new product reflect years of experience of A-C electronic engineers.

**Here's What it Can Do For You:**

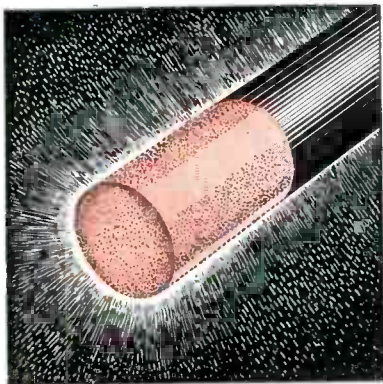

**FORGING:** Jobs are clean with no scale. No open flame, no furnace heat. Saves dies, offers heat zone control.

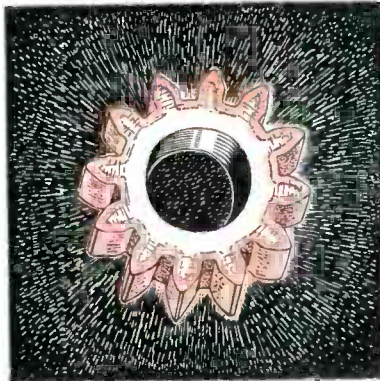

**HARDENING:** Cuts hours to minutes! Gives you hardened surface for long wear, ductile core for strength.

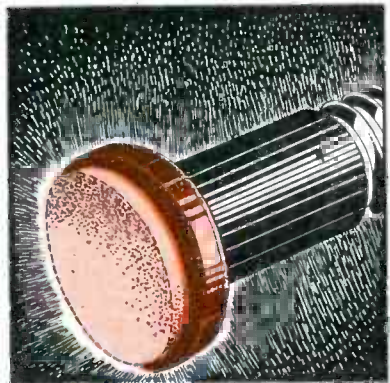

**BRAZING:** Fast, cheap, clean! Accurate heat control speeds production, insures more uniform results on all units.

**T**ODAY, the big swing is to Induction Heating — and here it is at its newest and finest in Allis-Chalmers new Electronic Heater! With this new production tool many manufacturing operations can now be performed better, faster, cheaper. A-C's Electronic Heater may be the answer to *your* production problems. Send samples for laboratory test. No obligation. **ALLIS-CHALMERS, ELECTRONIC DEVICES SECTION, MILWAUKEE 1, WIS.**

A 1886

**Chalmers** **MILWAUKEE**  
**WISCONSIN**

# LOWER YOUR COST of MANUFACTURING



## You'll find WHITAKER is a dependable source for Cables, Wiring Harnesses and Assemblies

Speed up your production, avoid unnecessary grief, and enjoy a lower cost of manufacturing by letting Whitaker supply your wiring assemblies, flexible leads and other cable products.

As specialists having a lot of experience and ample production facilities we are well prepared to supply engineered wiring service. Every step of our work is rigidly tested and checked. (Illustration above shows inspection for color code and

length of break-out on a harness being produced for a radio manufacturer). In this instance, or in your case, the delivered harness will be right for electrical continuity, for quality of workmanship, and ease of assembly.

In addition to an engineered wiring service, Whitaker also offers a quality line of standard cable products.

*Whitaker  
Can  
Wire It*

WRITE FOR DETAILS.

### WHITAKER CABLE CORPORATION

General Offices: 1307 Burlington Avenue, Kansas City 16, Missouri  
Factories: Kansas City, Mo. • St. Joseph, Mo. • Philadelphia • Oakland

1920--Silver Anniversary--1945



**an open and shut case of finer craftsmanship**

When you bring us your sheet metal fabrication problems, you hire 20 years of specialized experience in serving the highly individual needs of manufacturers of electrical, radio, electronic and mechanical apparatus. Our long history in this exacting specialty is one of intimate knowledge, and assures post-war permanence.

At your service are our 65,000 square feet of floor space . . . hundreds of skilled craftsmen . . . large stores of stock dies to save you money. Try us for chassis, panels, cabinets, racks, housings.

**ANY SIZE . . . ANY METAL . . .  
ANY GAUGE . . . ANY FINISH**

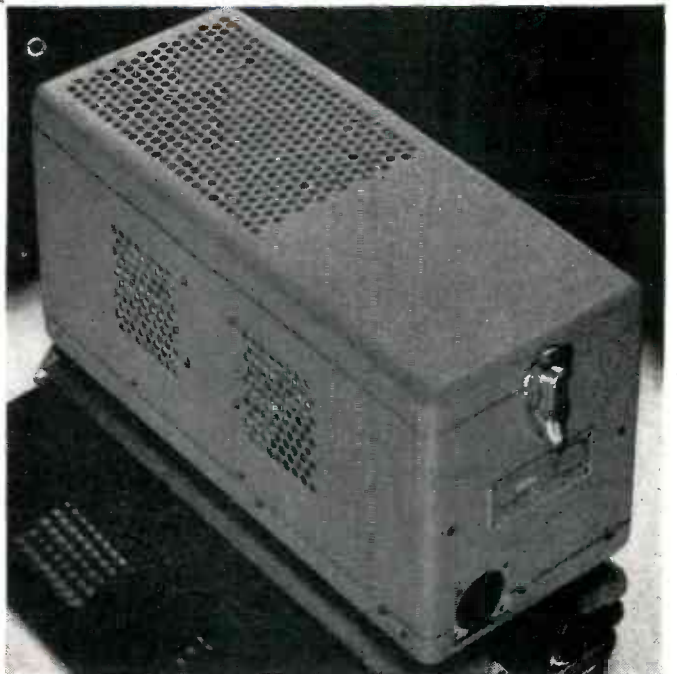

**KARP**  
**METAL PRODUCTS CO., INC.**  
*Custom Craftsmen in Sheet Metal*

124-30th Street, Brooklyn 32, N. Y.



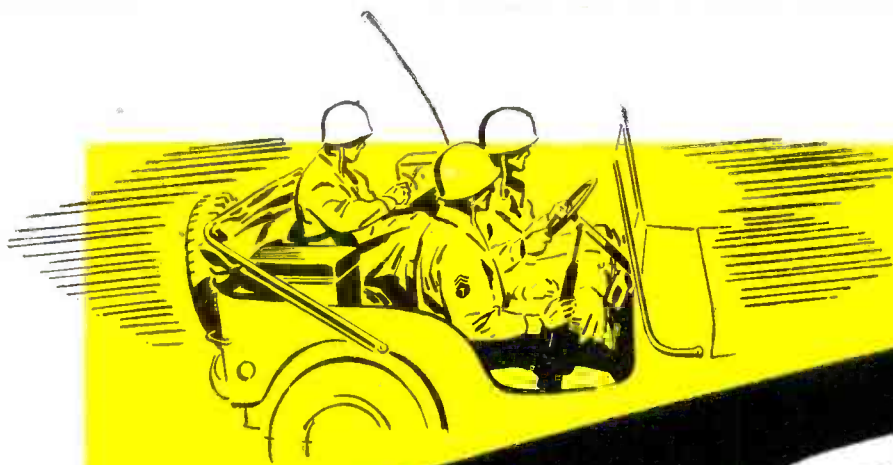

# The POWER Behind

Working with the Signal Corps in the creation of the now famous SCR-694, RAULAND Engineers had to solve many a knotty problem. None, however, proved as tough as producing the heart of the Vehicular Power Supply . . . the *Vibrator*. That power supply had to operate from a vehicular battery at 5.4 to 8 volts, 10.8 to 16 volts or 21.6 to 32 volts while maintaining filament voltage within the limits of  $\pm 5\%$  from nominal value. In addition it had to be fully immersion proof! The full story of how they licked a job that "couldn't be done" packs as dramatic a punch as anything in this man's war, but RAULAND Engineers *did it!* They designed and built the *highest frequency heavy-duty vibrator ever made . . .* to operate on 200 cycles  $\pm 1\%$ .

*The development of the PE-237 Vehicular Power Supply Unit, and especially the Rauland Vibrator JV-0014, is a typical example of RAULAND engineering thoroughness . . . the kind of electronic planning and craftsmanship that will be available for full cooperation with industry after this war.*



TRANSMITTER -  
RECEIVER OF  
THE SCR-694



VIBRATOR POWER SUPPLY  
FOR THE SCR-694

RADIO . . . RADAR . . . COMMUNICATIONS

# The SCR-694...



RAULAND VIBRATOR  
JV-0014  
used in Vehicular  
Power Supply  
PE-237

## ...The "HEART" that made it tick!

RAULAND VIBRATOR

A POWER VIBRATOR IN WHICH ARE COMBINED THESE DESIRABLE FEATURES:

- HIGH CURRENT CAPACITY — 35 amperes continuous duty
- MULTIPLE VOLTAGE — 6, 12, or 24 volt input to same vibrator
- HIGH FREQUENCY — 200 cycles
- WIDE TEMPERATURE RANGE — minus 40 to plus 70°C
- MULTIPLE CONTACT — 20 power contacts
- MAXIMUM UNIFORMITY OF LOAD DIVISION — each contact brought out to a separate base pin
- MINIMUM TRANSMISSION OF VIBRATION — heavy wall extruded case

*Electroneering is our business*



SOUND

# Rauland

TELEVISION

THE RAULAND CORPORATION • CHICAGO 41, ILLINOIS

# FM Station WEAFF-FM

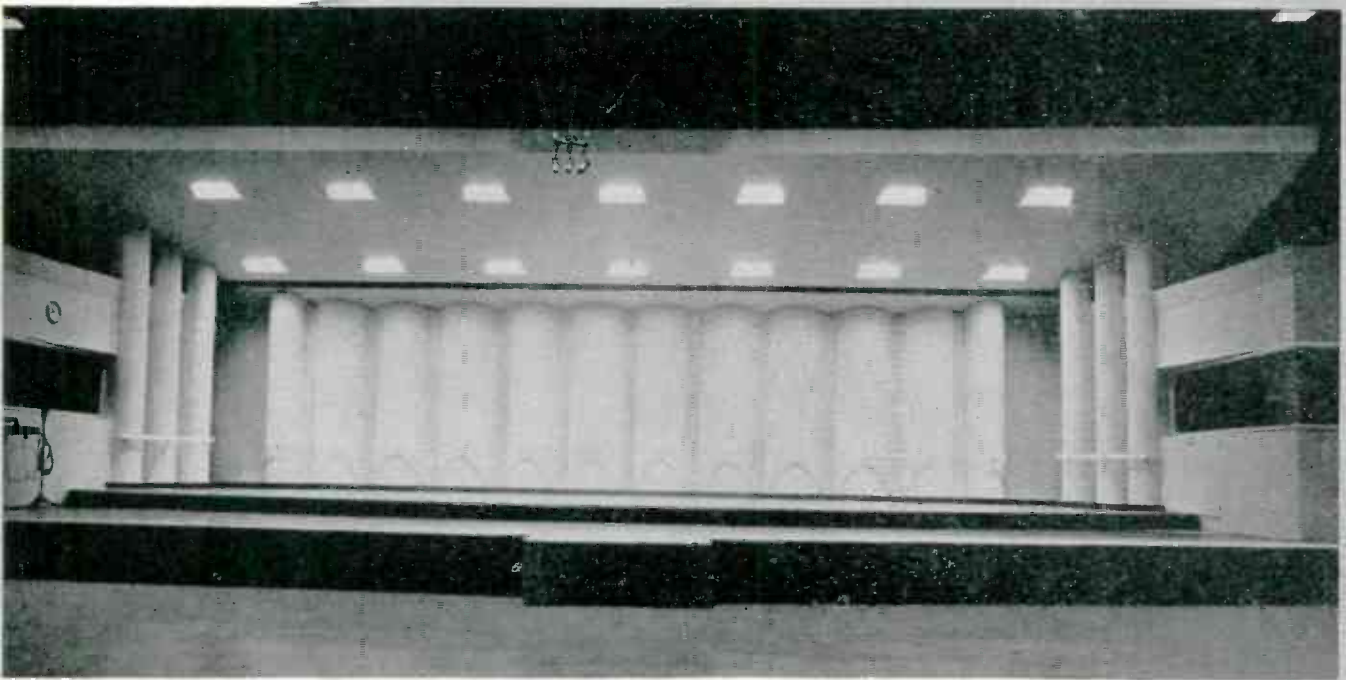

Above: Stage of NBC's studio 8-H This is one of several studios provided with polycylindrical sound diffusers in order to obtain improved high-frequency response. All of these studios use RCA 44-BX Microphones (on stage), and RCA 77-B Microphones (suspended from ceiling).

Below: Control booth of NBC's studio 6-A — another Radio-City studio in which many WEAFF-FM programs originate. The equipment in this booth is an RCA custom-built control console. Similar RCA consoles are used in all NBC studios, whether for AM or FM.

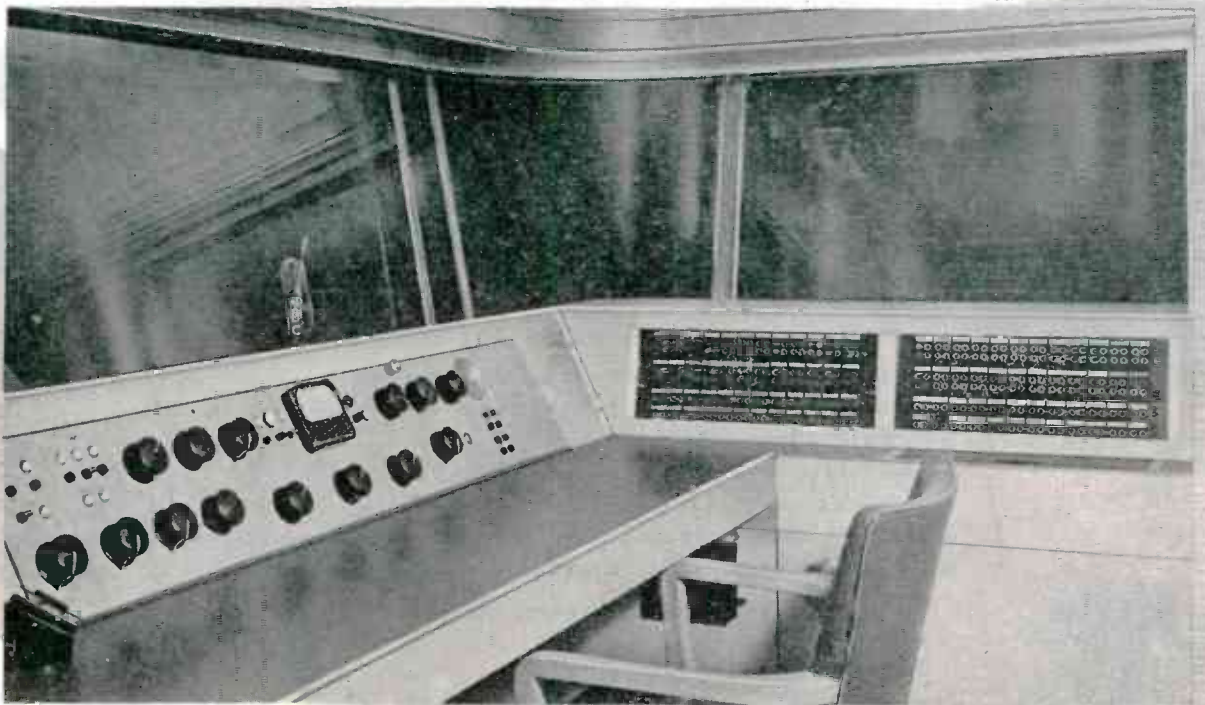

# uses **RCA** Equipment from Microphone to Antenna

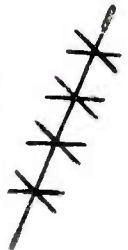

WEAF-FM, the New York FM station of the National Broadcasting Company, uses RCA equipment "from microphone to antenna." WEAF-FM programs originate in the network's Radio City studios, where RCA 44-BX and 77-B Microphones are used exclusively. They pass through studio control booths equipped with RCA custom-built control consoles, through the big network control panel in the master control room, and through the equipment room with its rows of rack-mounted RCA amplifiers. From the studios, WEAF-FM programs are fed by special high-quality telephone lines to the transmitter room at the Empire State Building. Here, not only the transmitter, but also the audio amplifiers, and the monitoring and test equipment, as well, are standard RCA units. The antenna (highest point in New York) is a specially designed system consisting of four dipoles arranged in a circle. This antenna was developed by RCA engineers in 1939. After the war, it

will be replaced by a new multiple-layer type.

That the equipment of WEAF-FM should be all-RCA is, of course, not surprising—for the National Broadcasting Company uses RCA-built equipment in all of its many broadcasting activities—AM, FM, and television. NBC engineers work with RCA engineers in the development of much of this equipment—field-test the models—and otherwise make available their unequalled operating experience. As a result, RCA broadcasting equipment is always up to date; incorporates the features operating engineers want; and, most important of all, is always "top quality."

Operators of both AM and FM stations—and station applicants—can make reservations right now for early delivery of RCA postwar broadcast equipment. For information on our Broadcast Equipment Priority Plan, write Broadcast Equipment Section, Radio Corporation of America, Camden, N. J.

BUY WAR BONDS



## RADIO CORPORATION OF AMERICA

RCA VICTOR DIVISION • CAMDEN, N. J.

In Canada, RCA VICTOR COMPANY LIMITED, Montreal

*Below: The RCA FM-10-A Transmitter of WEAF-FM. NBC was the first network to start FM broadcasting in New York City. The installation shown here is in the Empire State Building. Presently operating at reduced power, it will operate on full power as soon as wartime restrictions are lifted.*

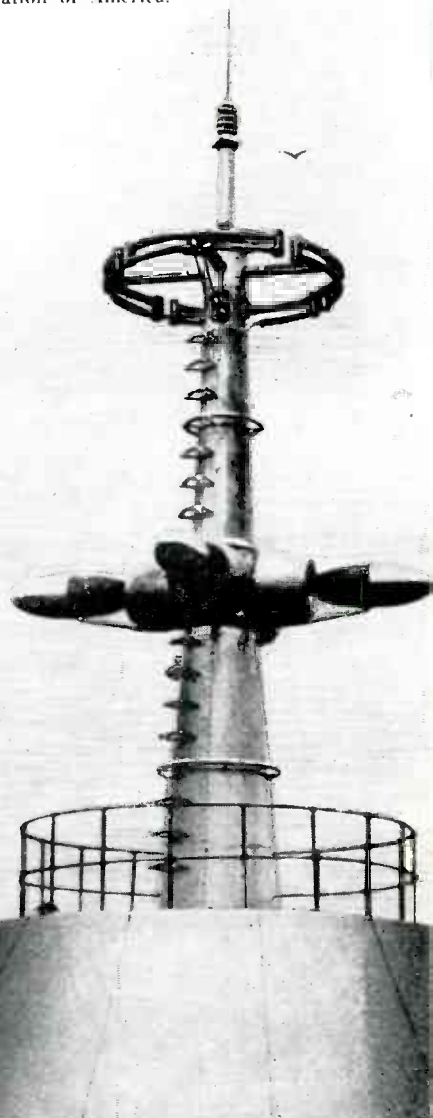
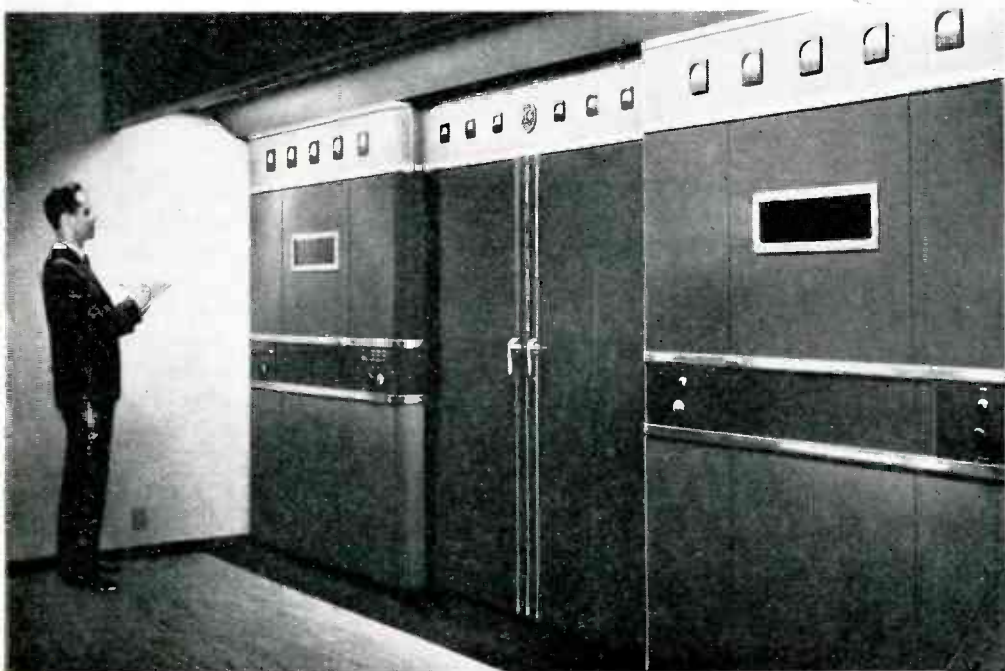

**PLASTICS**  
 where **PLASTICS** belong

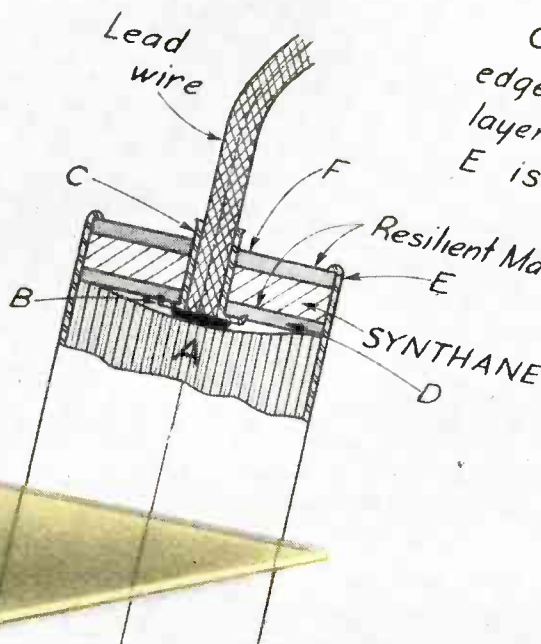

Condenser A jams upturned edge B of eyelet C into rubber-like layer D when condenser can E is crimped into layer F

## Using Mechanical and Dielectric Strength

SYNTHANE laminated phenolic, sandwiched between and bonded to layers of a resilient material, is the basis of an interesting plastics application.

The assembly—a condenser—depends upon the resilient material for a perfect seal when the edge of the can is crimped. Synthane backs up the resilient material, provides needed strength and ri-

gidity, and is also an excellent electrical insulator, unaffected by condenser oil.

In an application such as this, as in many others, it is desirable to consult our engineers before you design to see if Synthane can be used, and to decide which grade of Synthane will best meet your individual requirements and can be easily and readily produced. In fact, we

will work with you from design, through selection of material, down to the delivery of the finished plastics parts, relieving you completely from worry and responsibility. Synthane Fabricated Parts are produced by men who know how to make plastics and how to machine them, using specialized equipment. Synthane Corporation, Oaks, Pennsylvania.

**SYNTHANE TECHNICAL PLASTICS**



**DESIGN • MATERIALS • FABRICATION**

**SYNTHANE**



# How many of these forms of Synthane do you recognize . . . and use?



**1 SYNTHANE SHEETS**  
Made by curing layers or laminations of impregnated paper or fabric with heat and high pressure.



**2 SYNTHANE WRAPPED TUBES**  
Made by curing impregnated paper or fabric, wound about a mandrel, with heat.



**3 SYNTHANE MOLDED TUBES**  
Same as wrapped tubes except tubes are cured under heat and pressure in molds.



**4 SYNTHANE RODS**  
Produced by a method similar to that used in processing molded tubes.



**5 SYNTHANE MOLDED-LAMINATED**  
A means of producing parts in a finished or nearly finished form by curing layers of sheets under heat and pressure in molds. An economical way of making parts in quantity, retaining the desirable strength characteristics of Synthane sheet material.

**6 SYNTHANE MOLDED-MACERATED**  
Flakes of impregnated fabric are cured under heat and pressure in molds. More intricate parts can be formed than are possible by molded-laminated. Strength surpasses ordinary powder molding, does not equal molded-laminated.



**7 COMBINATION MOLDED-LAMINATED, MOLDED-MACERATED** Some parts requiring strength in certain sections but intricacy in others may be made by a combination of the molded-laminated, molded-macerated methods.

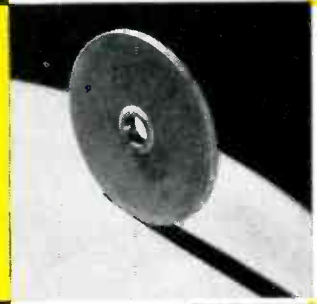

**8 COMBINATION MATERIALS**  
Synthane is sometimes bonded under pressure to other materials to achieve a combination of properties not obtainable any other way. The resiliency of rubber or Neoprene is often teamed with the strength and insulating characteristics of Synthane.

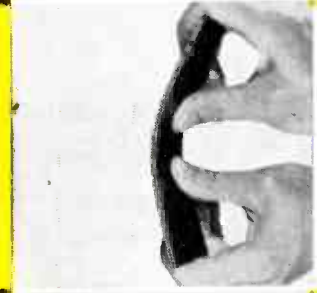

**9 SPECIAL MATERIALS**  
Synthane is available in special forms such as this graphited anti-friction Synthane. The inclusion of graphite is desirable on some applications.

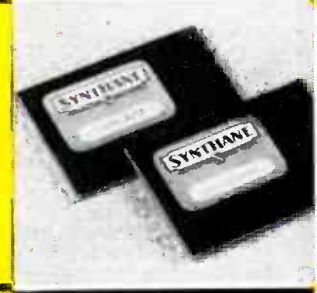

**10 FABRICATED PARTS**  
Synthane produces finished parts by machining sheets, rods, tubes or by molded-laminated or molded-macerated processes or by combining machining and molding operations.



SYNTHANE CORPORATION, OAKS, PENNA.

## SYNTHANE

Representatives in All Principal Cities

# Franklin's 39

## RADIO SOCKET

*The favorite yesterday, the favorite for tomorrow*

THE MANY MILLIONS INSTALLED IN 1941 IS

*Positive Testimony to its*  
**POSTWAR VALUE**

The story of Franklin's series 39 Radio Socket, with patented "U" shaped bow spring action contacts, is most remarkable ... developed and patented early in 1938 it received immediate acceptance and approval by practically all the radio set manufacturers and became standard equipment with most.

Series 39 sockets should be riveted to the chassis to become a permanent part of the set ... no replacement will be necessary as the socket will outlive the set.

Series 39 sockets were the favorite yesterday and will be the favorite tomorrow for standard broadcast receivers.

For the details of the 39, Diheptal, Miniature, Lock-in, Battery and Sockets for other applications, moulded or ceramic... and a complete line of Radio Components... write for the New Franklin Catalog with which is included a complete Buyers Guide for the Electronic Industries.



# A.W. FRANKLIN MANUFACTURING CORP.

SOCKETS • TERMINAL STRIPS • PLUGS • SWITCHES • PLASTIC FABRICATION • METAL STAMPINGS • ASSEMBLIES

175 VARICK ST., NEW YORK 14, N. Y.



This series 39 socket has a 39G Contact with a soldering tab which eliminates wiring to ground.

Illustrating the "U" shaped bow spring action contacts...39H and 39G...used in Franklin's series 39 Sockets.

Bow spring action maintains resiliency even after installation of oversize pins

Direction of metal grain prevents breaking of soldering tail and permits rough handling in production



"U" shaped contact provides separate soldering tail which prevents solder from flowing into contact body



The 39G contact has a soldering tab to eliminate wiring to ground... can be inserted in any position where grounding is desired.

# Callite filament



the heart of this Hytron Triode . . . .

The little HY75, medium-power triode, long a favorite of radio amateurs for its highly efficient operation at frequencies from 50 to 300 megacycles, now leads a versatile life. Widely used in War Emergency Radio Service networks, the HY75 has also found favor in Government and industrial research laboratories.

Callite supplies the Hytron Radio & Electronics Corp. with formed filament coils of 88.5 milligram thoriated tungsten wire for the HY75. Callite carefully processes tungsten wire with the right proportions of tungsten and thorium to give the required electronic emission, plus rugged strength to resist vibration and shock.

Leading tube manufacturers look to Callite for tube components, known throughout the industry for their quality and uniformity. It will pay you to investigate our complete range of metallurgical components. Callite Tungsten Corporation, 544 Thirty-ninth Street, Union City, New Jersey. Branch Offices: Chicago, Cleveland.

**Callite**  
tube components



Hard glass leads, welds, tungsten and molybdenum wire, rod and sheet, formed parts and other components for electron tubes and incandescent lamps.

# ERIE CERAMICONS\*

Leaders in the **WORLD** of **COMMUNICATIONS**  
as General Purpose Condensers



\*Ceramicon is the registered trade name of silvered ceramic condensers made by Erie Resistor Corporation.

## CHARACTERISTICS

CAPACITY RANGE IN MMF	JAN-C-20 STYLE	ERIE STYLE	MAXIMUM OVERALL DIMENSIONS
1 to 51	CC20	A	.200 x .400
	CC21	K	.250 x .562
52 to 110	CC25	B	.200 x .656
	CC26	L	.250 x .812
111 to 360	CC35	C	.265 x 1.125
	CC36	M	.340 x 1.328
361 to 510	CC40	D	.375 x 1.110
511 to 820	CC45	E	.375 x 1.560
821 to 1100	CC45	F	.375 x 2.00

## CHOICE OF TEN STANDARD TEMPERATURE COEFFICIENTS

**T**HE superior stability and performance of Erie Ceramicon have steadily increased the popularity of these silvered ceramic condensers since their introduction, now almost ten years ago. Today, they are literally leaders in the world of communications.

Strenuous war conditions have emphasized the necessity for equipment of unflinching reliability, and Erie Resistor has been called upon to furnish millions of Ceramicons, particularly as general purpose condensers, where a moderate degree of capacity change with temperature is permissible.

The superiority of Erie Ceramicons as general

purpose condensers for home receivers and civilian communications equipment, has been proved in numerous applications. They are ideal coupling condensers, as in plate-to-grid installations, where high insulation resistance is imperative.

Ceramicons may be selected from any one of 10 standard temperature coefficients, ranging from P120 to N750.

The capacity range for equivalent physical size is given in table above. We will gladly send you samples of Erie Ceramicons for your general purpose applications.



BUY MORE

Electronics Division

**ERIE RESISTOR CORP., ERIE, PA.**

LONDON, ENGLAND • • TORONTO, CANADA



WAR BONDS



*"Wedgie" Announces*  
 THE OPENING OF OUR NEW FACTORY AT  
**ESCANABA, MICHIGAN**  
 IN THE HEART OF THE HARD MAPLE  
 VENEER COUNTRY

The latest type of wood-working machinery in our new factory makes precision manufacture of wood wedges a speedy operation. Standard sizes and shapes are available for prompt shipment. Special shapes made to order.

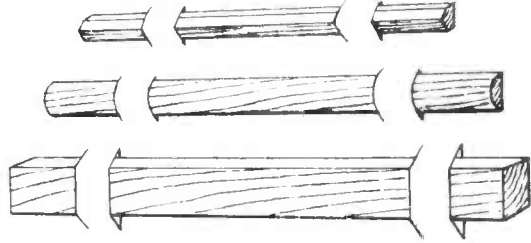

**9 FEATURES SPEED YOUR PRODUCTION . . . .**

- |   |  |   |
|---|--|---|
| <p><b>1</b> Production in our own factory assures uniform quality and delivery.</p> <p><b>2</b> Only well-seasoned, straight-grained, hard-maple used in manufacture.</p> <p><b>3</b> Straight-grained stock provides extra strength, resists breakage.</p> | <p><b>4</b> Furnished to accurate dimensions to fit every size of standard slot.</p> <p><b>5</b> Tumbled in paraffin to remove splinters and provide wax coating.</p> <p><b>6</b> Wax finish permits wedges to slide into position easily and quickly.</p> | <p><b>7</b> Large assortment of standard sizes meets every normal need.</p> <p><b>8</b> Low percentage of waste due to precision manufacturing.</p> <p><b>9</b> Lower in price than hard fibre; more readily available.</p> |
|---|--|---|

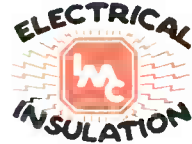

# INSULATION

## MANUFACTURERS' CORPORATION

★ CHICAGO 6  
 565 West Washington Blvd.

★ CLEVELAND 14  
 1005 Leader Building

Representatives in

MILWAUKEE 2: 312 East Wisconsin Avenue  
 DETROIT 2: 11341 Woodward Avenue

MINNEAPOLIS 3: 1208 Harmon Place  
 PEORIA 5: 101 Heinz Court

### OTHER IMC PRODUCTS

Vertex Varnished Cloth and Tapes—Varslot Combination Slot Insulation—Varnished Silk and Paper—Fiberglas Electrical Insulation—Manning Insulating Papers and Pressboards—Dow Corning Silicones—Pedigree Varnishes—Dieflex Varnished Tubings and Saturated Sleeveings of Cotton and Fiberglas—Hard Vulcanized Fibre and Fishpaper—Laminated Bakelite—Adhesive Tapes—Asbestos Woven Tapes and Sleeveings—Cotton Tapes, Webbing, and Sleeveings, and other insulating materials.

# Behind Push Button Tuning...



## STEATITE CONDENSER BASES ... strong — accurate — stable by **STUPAKOFF**

**S**TUPAKOFF steatite bases for padder and trimmer condensers provide stable insulation within the circuit—are precision built and withstand rapid assembly operations. They are made of fully vitrified, dense, hard and non-hygroscopic inorganic materials, resulting in low electrical losses and accurate tuning in complete assemblies. They go through riveting operations with little cracking or breaking, and once assembled, “stay put” because of their rigidity and permanence under changing conditions of atmosphere and temperature.

Dimensional accuracy—vitaly important to rapid assembly lines—is obtained by absolute control over every factor in the Stupakoff method of manufacture. Precision is the watchword with Stupakoff—and precision on a mass production scale.

During the past twenty years Stupakoff has supplied hundreds of millions of ceramic parts to the radio industry. It is suggested that you bring your insulation problems to Stupakoff—specialists in developing insulators to satisfy the most exacting standards and requirements.



BUY MORE WAR BONDS



**STUPAKOFF CERAMIC AND MANUFACTURING CO., LATROBE, PA.**

*Products for the World of Electronics*

# INSULATED

## TO YOUR SPECIFICATIONS

### ALL DRIVER-HARRIS

### Resistance Alloy Wires

All Driver-Harris resistance alloy wires can be supplied to you with any of these individual types of insulation either in single or multiple coatings or in various combinations to meet special requirements.

The spools of D-H wire illustrated are insulated as follows:

- 1—Formvar Enamel Coated
- 2—Double Cotton Covered
- 3—Double Enamel Coated
- 4—Double Glass Coated
- 5—Single Silk Covered
- 6—Double Silk Covered
- 7—Enamel Coated
- 8—Resin Over Glass Coated
- 9—Single Cotton Covered

Additional technically advanced insulations now in research will be added to this list. Send us your specifications.

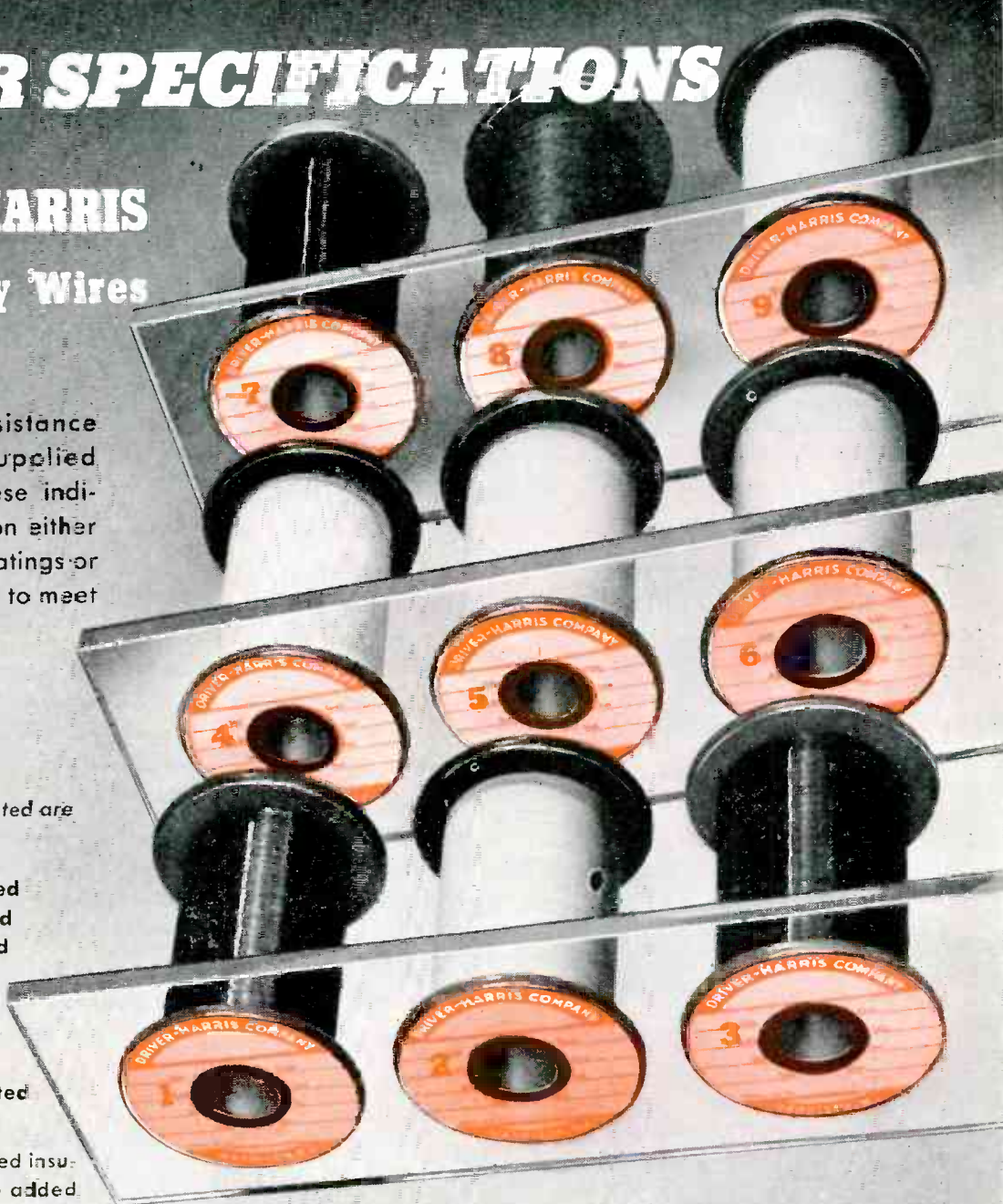

Famous for NICHROME\*

## Driver-Harris COMPANY

HARRISON, N. J.

Branches: Chicago • Detroit • Cleveland  
Los Angeles • San Francisco • Seattle



\*Trade Mark Reg.  
U. S. Pat. Off.

# Who sets the *Quality Standard*



QST #1 Filament and Grid support wire is "miked" and weighed to meet specifications since slightest variations affect tube characteristics and performance.



QST #2 Quantitative analysis of Filament Sprays and Chemical Getters is made to insure correct ratios of the active ingredients.



QST #3 Although triple-distilled the Mercury used in United tube is further processed to prevent contamination by minute traces of impurities.

## FOR TRANSMITTING TUBES

STEP-BY-STEP, from raw material to final product, nothing is taken for granted at United. For instance, all raw materials that enter into the evolution of a United tube are checked and tested with searching chemical and metallurgical care in our own laboratory pictured above. These tests complement our regular inspections for exacting mechanical standards.

Such vigilant Quality Standard Tests of raw materials are essential to assure the sterling qualities of United Tubes. For the name United carries a great responsibility with engineers everywhere. It is a *trusted standard* for comparing transmitting tubes which must be zealously guarded and always maintained.

But the final test rests with you, so let United tubes prove themselves by actual performance. Try them when you make your next replacements. Write for a copy of our latest catalog. Order direct or from your Electronic Parts Jobber.

\*Quality Standard Test

*Masterpiece of Skilled Hands*

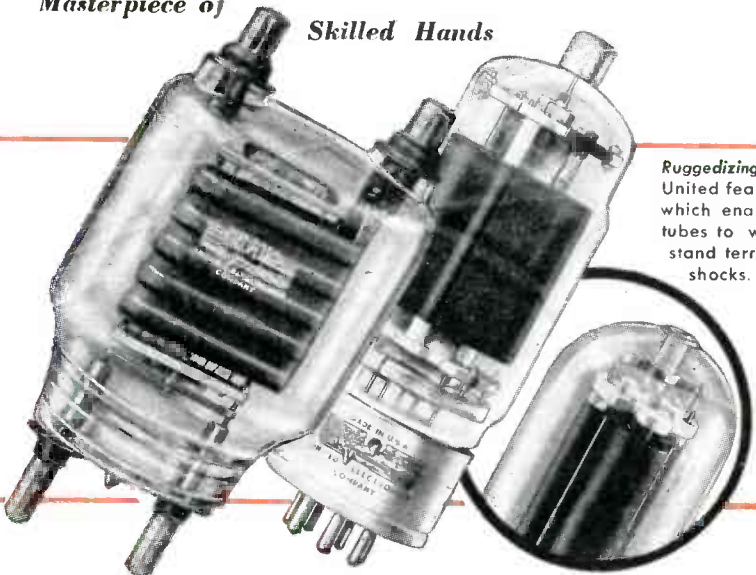

**Ruggedizing:** A United feature which enables tubes to withstand terrific shocks.



# UNITED

ELECTRONICS COMPANY

NEWARK, 2



NEW JERSEY

Transmitting Tubes EXCLUSIVELY Since 1934



**From Drying to Gluing**



## **ELECTRONICS Does it Better**

*For the PAPER Industry*

Many of the present-day methods in the making of paper are due for imminent obsolescence. Leaders in the industry have already re-oriented their thinking in terms of electronics. For, in paper making as in other industries, electronics will do the job better—and do it for less! It will simplify manufacturing processes, provide automatic controls, insure uniform quality, save vital manpower . . . As an engineering service and manufacturing organization, we have been identified with outstanding companies in the design, development and manufacture of custom-built electronic equipment. Our engineers are available for consultation. Write to learn how Sherron Electronics can help you.



### *How Electronics Can Serve the Paper Industry*

**ELECTRONIC HEATING**—for process drying and gluing.

**ELECTRONIC CONTROLS**—for illumination, speed, slack and tension. Heating Controls for processes, such as, digester cooking.

**ELECTRONIC REGULATION**—for color matching, reflectance, gloss and opacity.

**ELECTRONIC** Counters and flaw detector.

pH Determination by electronic measurement and associated control devices.

**ELECTRONIC** measurement and control of sulphite liquor in its various stages of processing

**ELECTRONIC** flow indicators, regulators and alarms

## **SHERRON ELECTRONICS COMPANY**

*Division of Sherron Metallic Corporation*

1201 FLUSHING AVENUE

BROOKLYN 6, N. Y.

**"Where the Ideal is the Standard. Sherron Units are Standard Equipment"**

**Sherron  
Electronics**

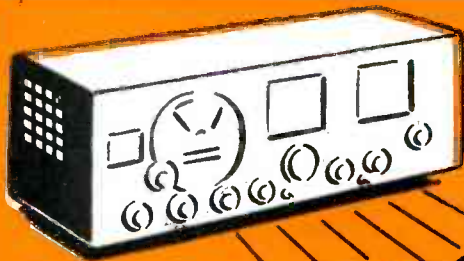

# Simplify your REMOTE CONTROL PROBLEM with this new



## Automatic STEPPING SELECTOR

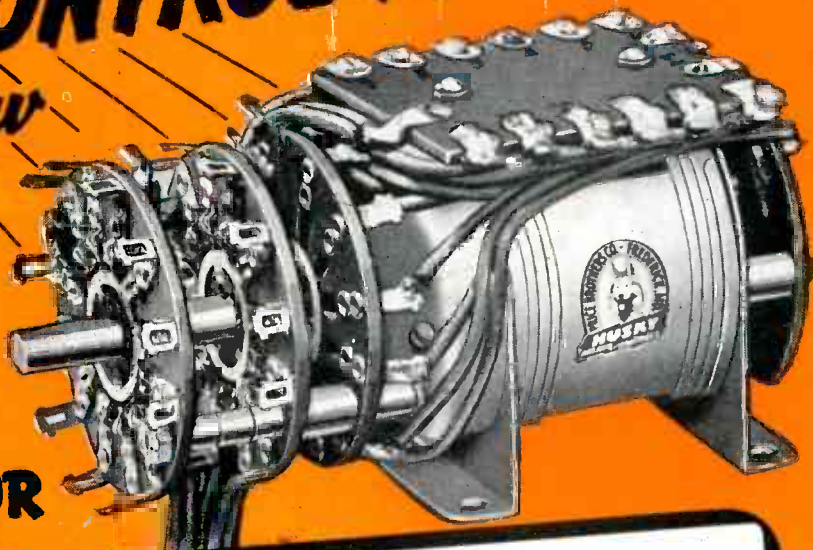

### TYPE 8210 Automatic STEPPING SELECTOR

- ☆ Single Unit replaces motor, gear train, and switch assembly.
- ☆ Operates Standard Wafer Switches.
- ☆ Designed for D.C. operation. Can be adapted to A.C. under special conditions.



The #82-10 Relay is the latest addition to the RO-T-RY family, which already includes the RO-T-RY actuator for operation of 30° wafer switch, the #82 Stepping Relay, and the Dual RO-T-RY incorporating two coils for giving 30° rotation in either direction.

The #82-10, as illustrated, consists of a ratchet motor and special repeater switch, a 12 point position selecting wafer, and a terminal board. The unit is completely wired so that a 13 conductor remote control circuit may be connected directly to the terminal board. When the control circuit is terminated by a 12 position push button or rotary switch, the selector unit will index in a counter-clockwise direction to any posi-

tion selected. When the selector unit is at rest, no current flows in the relay coil or control circuit.

Various shaft extensions are available for driving up to 4 wafers, which mount directly on the unit. When the unit is built up as illustrated, possible applications suggesting themselves would be—push button tuning for receivers and push button crystal selection for transmitters.

The unit may also be used as a ratchet motor to drive any load requiring up to 12 in. oz. torque. When furnished for this purpose the terminal board and wafers are omitted and a shaft extension is furnished as required.

### Get Catalog E-58

Illustrates "RO-T-RY" adaptability to unusual and varied relay applications. Complete specifications and detail drawings. Also illustrates other Price Bros. Co. Relays for Time Delays, Motor Starting, High Speed Keying, Antenna and Power Connectors. Write today for this Catalog.

# Price BROTHERS CO.

FREDERICK, MARYLAND

Relays and Controls for Electronic, and Industrial Applications





## **G**lobal shrinking

**P**ART of our business is making the world smaller—by telescoping time and space with *speed*. ■ We contribute to the process in two ways. First, electronically. With radio communication equipment that shrinks thousands of miles into an instant. Such as the **Aireon** Type 508 Transmitter for ground-to-plane and point-to-point conversation. It's used by the Army Air Transport Command and commercial airlines to monitor global air traffic, keep planes hopping. ■ Second, hydraulically. With fast-acting power actuators and controls. Precision designed for war-planes, cargo carriers and commercial aircraft that make ponds out of oceans, islands out of continents. ■ Electronic or hydraulic, it's our stuff; designed and built from the ground up by **Aireon** engineers with real technical savvy and produced in plants equipped to handle precision work on a quantity basis. The same combination is available to handle your problems whenever you say.

**Aireon** MANUFACTURING CORPORATION  
Radio and Electronics      Engineered Power Controls

NEW YORK • CHICAGO • KANSAS CITY • BURBANK

## **Marion Glass-to-Metal Truly Hermetically Sealed 2½" and 3½" Electrical Indicating Instruments**



**We've been *delivering them* since April 15, 1945!**

Since April 15, 1945, we of Marion have been shipping our glass-to-metal hermetically sealed electrical indicating instruments to different branches of the Armed Services. They've been vacuum checked and inspected in accordance with latest test procedures recommended by the Services. Our capacity is continuously increasing, and essential users may, therefore, expect 60 to 90 day deliveries on most ranges. May we supply you with samples for your particular requirements and specifications? Deliveries, at present, on these is approximately 30 days. The same type of service that we are rendering in wartime will be in effect in peacetime, when Marion hermetically sealed instruments will help sustain the performance of radio and electronic equipment throughout the world.

**They're *positively interchangeable*—and they cost no more than standard unsealed instruments.**

Write for our new, 12-page brochure. We welcome "jobs" calling for instruments with new and special characteristics for new and unusual applications.



MARION ELECTRICAL INSTRUMENT CO.  
MANCHESTER, NEW HAMPSHIRE

WASTEPAPER IS AMERICA'S NO. 1 CRITICAL WAR MATERIAL... SAVE EVERY SCRAP



**PLIOTRON WL-473**  
**typical operation**

R. F. Power Amplifier and Oscillator Class C	
Plate Volts, D-C	3,000
Plate Current, D-C. Amperes	1.4
Driving Power, Watts	330
Plate Power Output, Watts	3,250
Plate Volts and Input for 60 MC	100%

**Transconductance**

**12,000**

**PLATE OUTPUT:  
 3,250 WATTS AT 60 MC**

**PLATE EFFICIENCY:  
 78%**

**This exclusive Westinghouse Plotron  
 opens new opportunities for improving  
 design of electronic equipment**

©1945, Westinghouse Electric Corporation

**Westinghouse**

TUNE IN: John Charles Thomas—Sunday, 2:30 P. M., EWT—NBC  
 Ted Malone—Mon. through Fri., 11:45 A. M., EWT—Blue Network

The exceptionally high transconductance of the Westinghouse Plotron WL-473 assures high power at low operating plate voltage. This compact, powerful, dependable tube opens new horizons to engineers who are designing dielectric and induction heating equipment and AM and FM transmitters. For complete technical data on this exclusive Westinghouse tube, consult your nearest Westinghouse office or write Westinghouse Electric Corporation, Electronic Tube Sales Department, Bloomfield, New Jersey.

*Electronic Tubes at Work*

352 SERIES

GC-352 SERIES

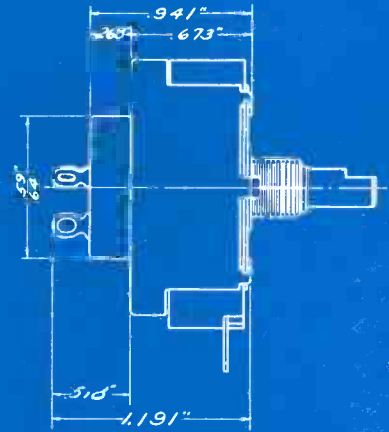
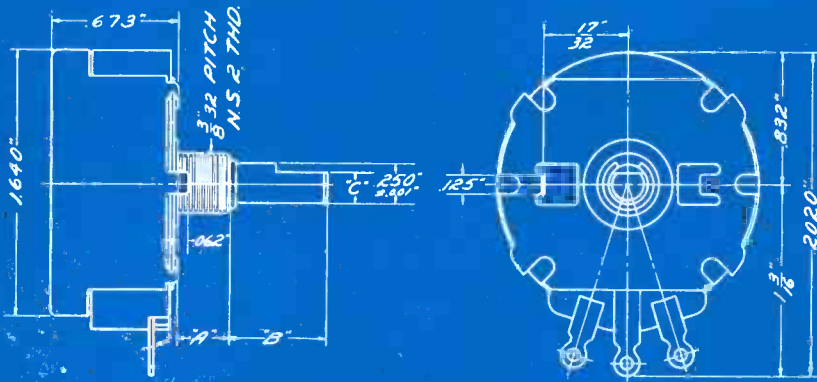

SPACE REQUIREMENTS FOR 352 SERIES AND GC-352 SERIES

3 watt wire wound variable resistor



Actual Size

★ Throughout the world, experienced electronic engineers know that they can safely leave all worries and headaches about variable resistors to Chicago Telephone Supply Company.

They know from experience that an order placed with CTS means: —

- A variable resistor engineered for the application.
- Precision Workmanship.
- Uniform quality throughout the shipment.
- Delivery when promised.



CHICAGO TELEPHONE SUPPLY  
Company

ELKHART • INDIANA

REPRESENTATIVES

R. W. Farris Co.  
406 West Thirty-fourth Street  
Kansas City 2, Missouri  
Phone: Logan 7495

Frank A. Emmet Co.  
2837 West Pico Boulevard  
Los Angeles 6, California  
Phone: Rochester 9111

BRANCH OFFICES

S. J. Hutchinson, Jr.  
401 North Broad Street  
Philadelphia 8, Pennsylvania  
Phone: Walnut 5389

IN CANADA

C. C. Meredith & Co.  
Streetsville, Ontario

IN ENGLAND

Chicago Telephone Supply Co.  
St. John's Woods  
103 Grove End Gardens  
London, N. W. 8, England

IN SOUTH AMERICA

Jose Luis Pontet  
Cordoba 1472  
Buenos Aires, Argentina  
South America  
Masculino 2624  
Montevideo, Uruguay  
South America  
Avda. Conselheiro Rodrigues  
Alves 1057  
Villa Mariana  
Sao Paulo, Brazil  
South America

VARIABLE RESISTORS • PLUGS AND JACKS  
SWITCHES • RINGERS • TELEPHONE GENERATORS

Manufacturers of Quality Electro-Mechanical Components Since 1896

**It's NEW! It's RUGGED!**

**304-H**

*Gammatron*



## **Here's a low voltage—high current tube with superior mechanical strength!**

Heintz and Kaufman engineers have developed the new 304-H Gammatron in response to the demand for a low voltage—high current tube possessing greater mechanical strength than the earlier type.

Short, stocky construction and other improvements give the new 304-H a degree of ruggedness which will surpass your expectations. Moreover, this added strength has been achieved without the use of internal insulators.

Although we designed this new Gammatron primarily for ability to withstand bumps, shocks and vibration, certain electrical improvements have also been obtained. The result is a tube

which will have widespread use in electronic heating applications, and as a gate or keyer tube. Its ruggedness, and consequent longer life, materially reduces operating costs.

For data on the electrical characteristics and price of the 304-H Gammatron, please write to

**HEINTZ AND KAUFMAN LTD.**  
SOUTH SAN FRANCISCO • CALIFORNIA

KEEP BUYING  WAR BONDS

*Gammatron Tubes*

Export Agents: M. SIMON & SON CO., INC.  
25 WARREN STREET, NEW YORK CITY, N. Y.

# PLASTIC PARTS

..... PRODUCED TO YOUR SPECIFICATIONS

## PRINTING DIE CUTTING CEMENTING

Wide experience by all known processes in the application of printing, engraving, silk screening, die cutting and cementing of all thermoplastics.

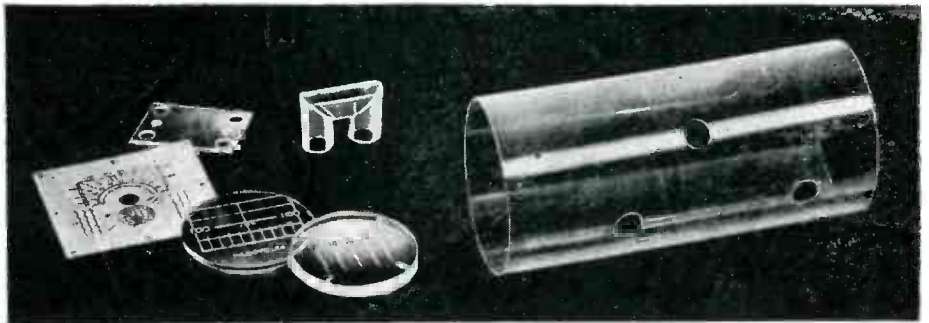

## FORMING

Specialists in deep drawing radio dial windows, embossing, swaging and bending in Acetate, Vinylite and Acrylics.

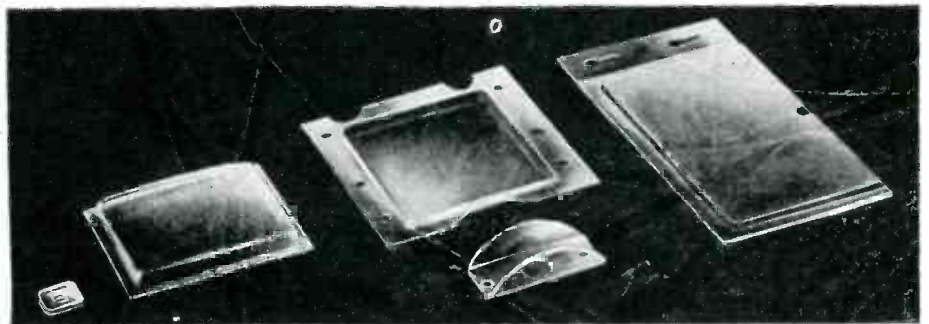

## MACHINING

Precision threading, screw machine, milling, drilling, turning of Polystyrene, Acrylics, Phenolics, Nylon, Tenite; sheets, tubes and rods; through spindle capacity up to 2½" rod.

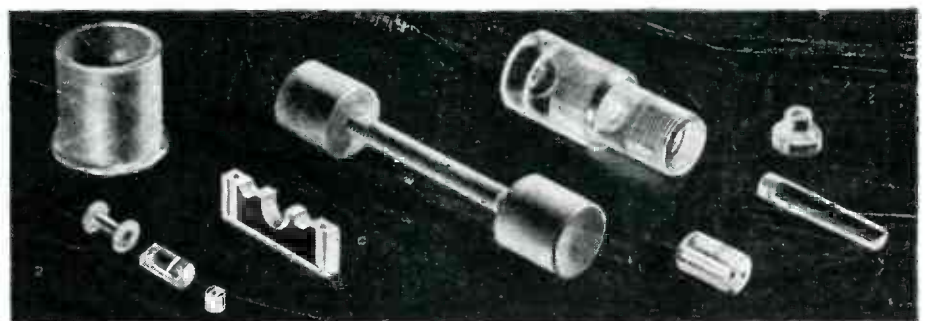

## ASSEMBLY

Our engineers can assist you in problems of design and assembly of your plastic units.

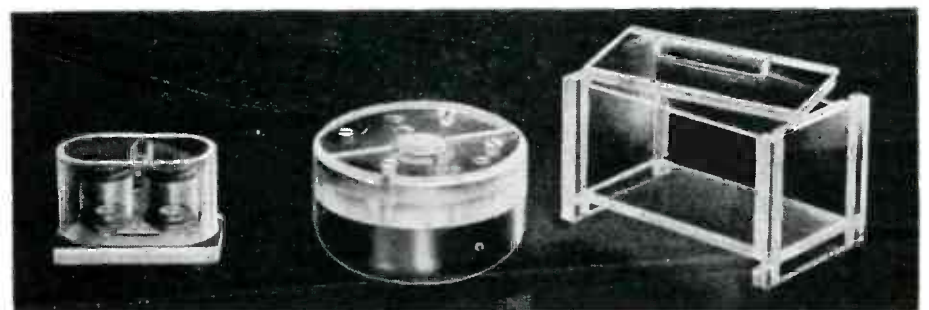

# PRINTLOID, Inc.

93 Mercer Street  
New York 12, N. Y.



# HERE'S PROOF...

How Federal H-F Cable  
Quality is Controlled by

*Actual Test*

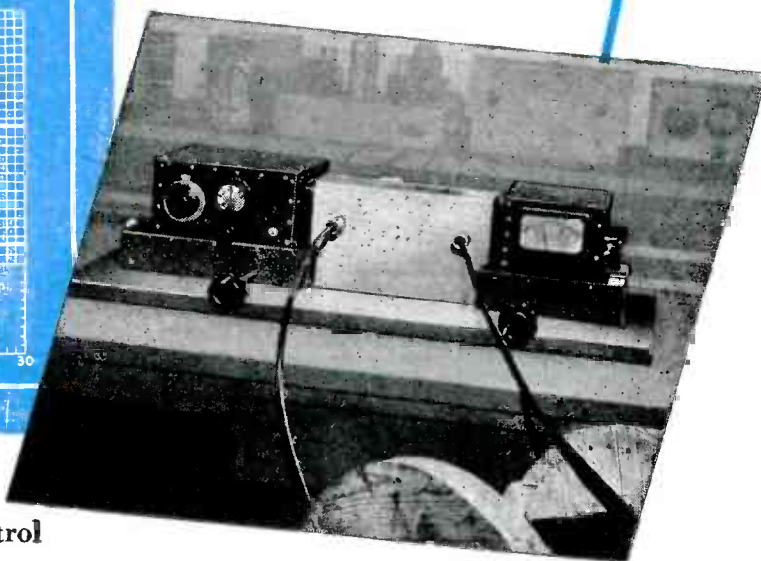
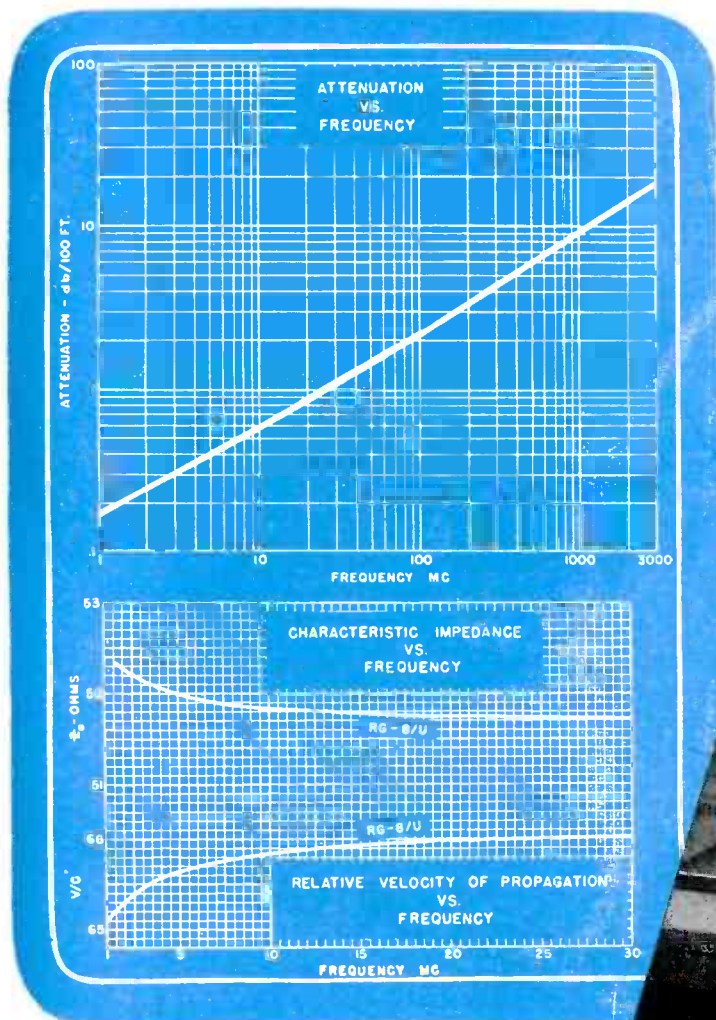

Precision engineering—plus careful control of all manufacturing operations... from raw materials to finished product—mean complete reproducibility in any given Intelin Cable type... and overall superior cables.

Take Intelin RG-8/U for instance... general purpose "work-horse" of high-frequency cables. Its characteristics are shown in curves obtained—not from nominal design values—but from thousands of actual measurements on cable samples, with special equipment developed and used exclusively by Federal's Intelin Product Line.



Intelin's Attenuation Meter is an example of such equipment. It's a precision instrument... accurate to .1 db... developed by Intelin to provide a constant check on production quality and "measured" data for the equipment designer.

For additional information regarding Intelin RG-8/U... write *today* for Report E-53 —and for cable you can count on... *always* specify INTELIN.

## Federal Telephone and Radio Corporation



Newark 1, N. J.

**4800 Capacitance Ranges for Standard Tubular Sizes**

(These curves allow for  $\pm 5\%$  capacitance tolerance)

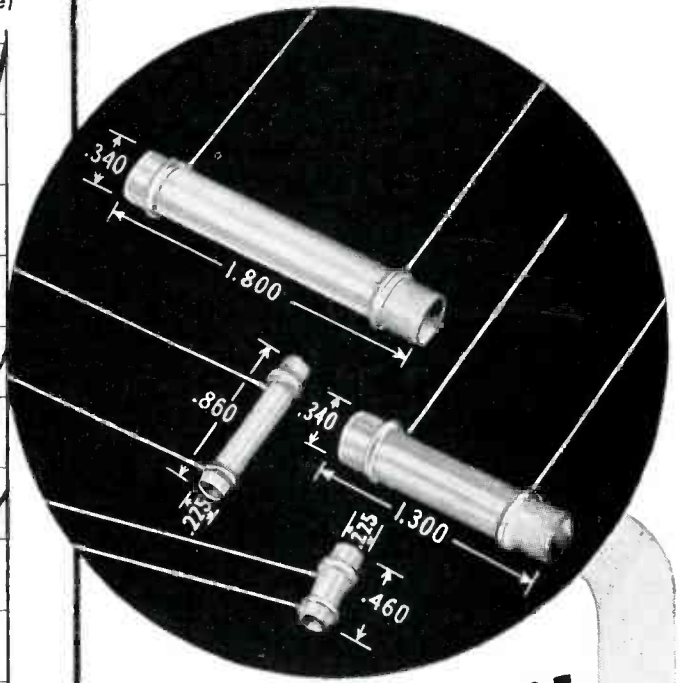
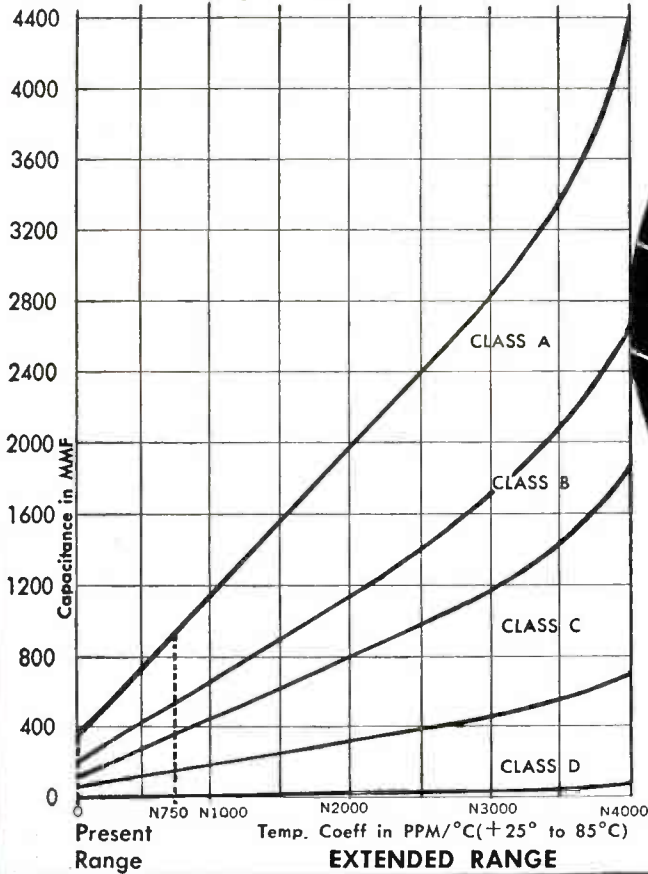

**A New RANGE OF**

**CONTROLLED TEMPERATURE COMPENSATING CAPACITORS**  
*by* **Centralab**

Centralab Tubular Ceramic Capacitors can now be supplied in any desired temperature coefficient from P120 to N4000 parts per million per degree Centigrade.

The range from N750 to N4000 P.P.M. is new, with the same accuracy of temperature compensation curve and uniform electrical characteristics as the present standard ranges.

The new ceramic bodies have somewhat higher dielectric constants and thus provide higher values of capacitance on the same size tube. They are not to be confused, however, with the so called Hi-K or high dielectric bodies that have still higher dielectric constants but less uniform characteristics.

*Producers of:*

- Variable Resistors — Selector Switches — Ceramic Capacitors, Fixed and Variable — Steatite Insulators — and Button-Type Silver Mica Capacitors.

**Centralab**

**Division of GLOBE-UNION INC., Milwaukee**



**NO...  
He didn't TAP!**

**THIS SCREW ACTUALLY CUTS ITS OWN THREAD—ELIMINATES COSTLY TAPPING OPERATIONS—SAVES VITAL ASSEMBLY TIME!**



Also Available  
With Phillips  
Recessed Heads

**SHAKEPROOF**  
**TYPE 1**  
**THREAD-CUTTING SCREWS**

Now you can eliminate taps and tapping operations! The Shakeproof Type 1 Thread-Cutting Screw cuts its own perfect mating thread, and a snug, tight fit is always certain.

It's the specially designed serrated cutting edge of the Type 1 that does the job. Try this modern fastener now... you will find it speeds assembly and cuts costs!

Shakeproof Engineers are ready to help you incorporate the Type 1 into your product... ask for this helpful service now!

**SHAKEPROOF inc.**  
*"Fastening Headquarters"*



Distributor of Shakeproof Products Manufactured by ILLINOIS TOOL WORKS  
2501 North Keeler Avenue, Chicago 39, Illinois

Plants at Chicago and Elgin, Illinois • In Canada: Canada Illinois Tools, Ltd., Toronto, Ontario  
Los Angeles Office: 5670 Wilshire Blvd., Los Angeles, 36, Calif. • Detroit Office: 2898 E. Grand Blvd., Detroit 2, Mich.

**APPLICATION SUGGESTIONS  
IN FREE BULLETIN!**

This bulletin illustrates and explains various applications of Shakeproof Type 1 Thread-Cutting Screws. Write for it today... specify Bulletin No. 5. If you wish, we will send you the complete series.



# Rigid Inspection

## the secret behind the success of Schweitzer Condenser Paper

Long years of experience in the production of thin gauge insulating papers has taught Schweitzer what to look for.

A system of rigid inspection at every point of manufacture insures the perfection...and results in fewer rejections ...of the finished products whether they be condensers, coils, transformers or other insulating units.

  
**SCHWEITZER PAPER CO.**

142 MILLER STREET, NEWARK, N. J.

Plants: Newark, Jersey City, N. J.; Mt. Holly Springs, Pa.

Research Laboratories: Chrysler Bldg., New York, N. Y.

SPECIALISTS IN THIN GAUGE INSULATING PAPERS



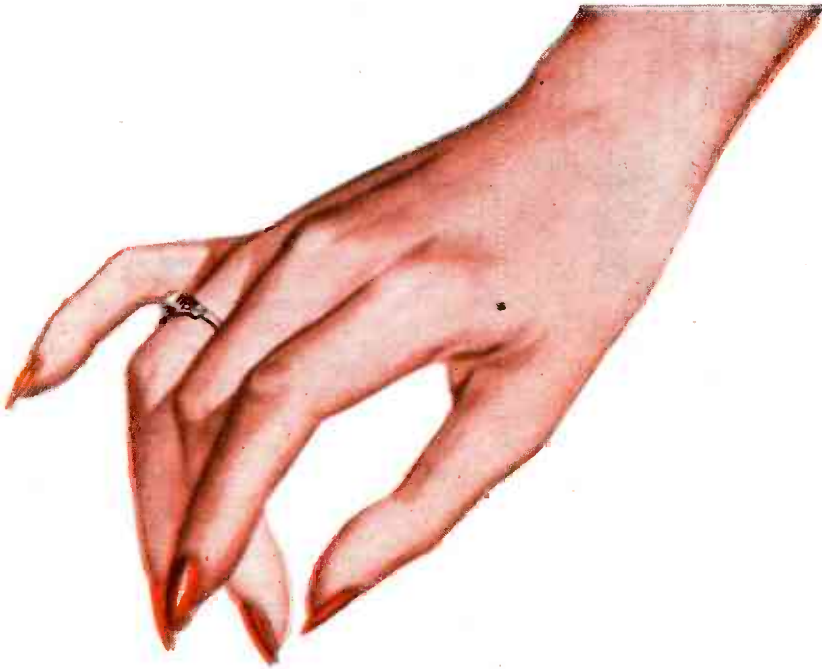

# QUIET



In one expressive word you have the reason why so many phonographs will be powered by a BALLENTINE motor drive.

To the user, *quiet* means low background noise.

To the engineer, *quiet* means minimum vibration, dynamic balance, rigid adherence to close tolerances, modern manufacturing methods and equipment.

With BALLENTINE phono motor drives, you are assured of lowest rumble. Send today for descriptive folder on the *quiet* BALLENTINE phonograph motor drive.

**RUSSELL ELECTRIC CO.,** 364 W. HURON STREET, CHICAGO, ILLINOIS • MANUFACTURERS OF  
**BALLENTINE PHONOGRAPH MOTOR DRIVE**

# 2608 OPPORTUNITIES to make

● There are 2608 G-E capacitor ratings now being applied in all fields where capacitors are used. We believe you will find that the long life and dependability of these components will add extra reliability to *your* equipment—giving you, over a period of years, substantial savings in replacement costs and servicing. In addition, many equipment manufacturers have found that use of G-E capacitors often appreciably reduces the size, cost, and weight of their product.

The high quality of these units has been made possible by new processing techniques, together with improvements in hermetic sealing, bushing construction, and G-E developments in dielectric materials such as Pyranol, lectronol, lectrofilm, and extra-thin kraft paper.

Here are some of the more important items in this ever-widening line that it will pay you to investigate.

## CAPACITORS FOR D-C APPLICATIONS

Fixed paper-dielectric capacitors, hermetically sealed in metallic containers, built in accordance with the Proposed Joint Army-Navy Spec. JAN-C-25. All units can be obtained in either Pyranol (Characteristic F) or mineral-oil (Characteristic E) types. CP-50 to 55 in single-, dual-, or triple-section units; CP-60 to 65 in single- or dual-section units with conventional or glass terminal seals; CP-70, all listed ratings, with or without removable mounting brackets.

Ask for Bulletins GEA-4357 and GEA-4424

## CAPACITORS FOR NORMAL-FREQUENCY A-C CIRCUITS

Motor capacitors in rectangular or cylindrical cases

Ballast capacitors for use in high-power-factor ballasts for fluorescent lamps

Capacitors for ignition transformers or other specialty transformer applications

Ask for Bulletin GEA-2027

## CAPACITORS FOR HIGH-FREQUENCY APPLICATIONS

Lectrofilm capacitors for radio-frequency blocking

## MEET G.E.'S EXPANDING LINE OF CAPACITORS



A representative group of the 2608 ratings available—from .000047 to 375 mu f

# ong-range savings

and by-pass applications, in Case-60, -65, and -70 types  
Ask for Bulletin GEA-4295

Parallel-plate capacitors for resonant circuits of high-frequency induction heaters or other electronic oscillators  
Ask for Bulletin GEA-4365

Paper-dielectric capacitors for grid and plate blocking and by-pass service in electronic oscillators  
Ask for Bulletin GEA-4388

Capacitors for high-voltage networks, flash photography, discharge welding, impulse generators, and other energy-storage applications.  
Data on request

For complete descriptive and application information, ask for the bulletins indicated. Where a bulletin is not listed, if you will let us know of your problem or requirements, we shall be glad to supply the data you need.  
*General Electric Co., Schenectady 5, N. Y.*

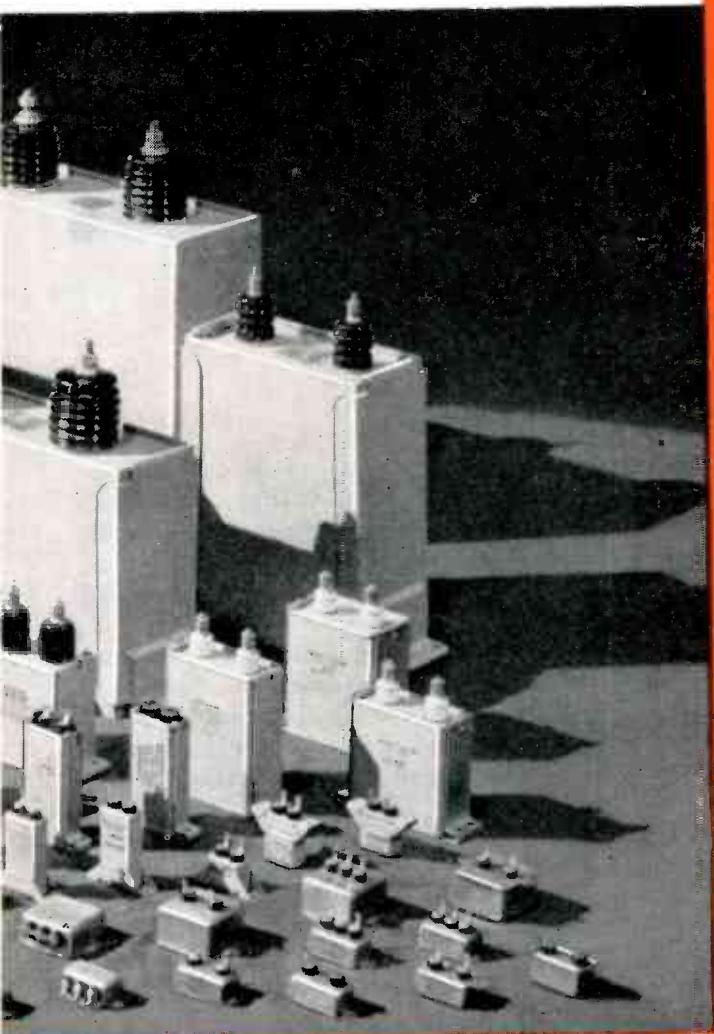

Here's the kind of help we can give you on your new circuits

Extracted from "Induction Heating—A History of Its Development," by Frank T. Chesnut, Ajax Electrothermic Corp., Iron Age, March 22, 1945.

The first capacitors were hand made, with sheets of brass and photographic glass plates alternately stacked and immersed in an oil bath. The capacity of the units necessarily was low, and the dielectric so poor that breakdown was the rule. A furnace would operate for a period of from seconds to half an hour, when the capacitors would fail.

Dr. Northrup finally appealed to the General Electric Co. to make him a high frequency power capacitor. The early co-operation of General Electric Co., especially in respect to these capacitors, made induction heating possible from a practical standpoint. Although good capacitors are now being made by others, it can be said fairly that the General Electric Co. has consistently led the world. Capacitor units of 300 kva. are now no larger than 1/3 cu. ft. volume.



"Made induction heating practical"—This bank of G-E water-cooled capacitors is used with two Ajax-Northrup induction-type steel furnaces in a Western metals plant.



CAPACITORS

for built-in applications

GENERAL  ELECTRIC  
407-91-5730

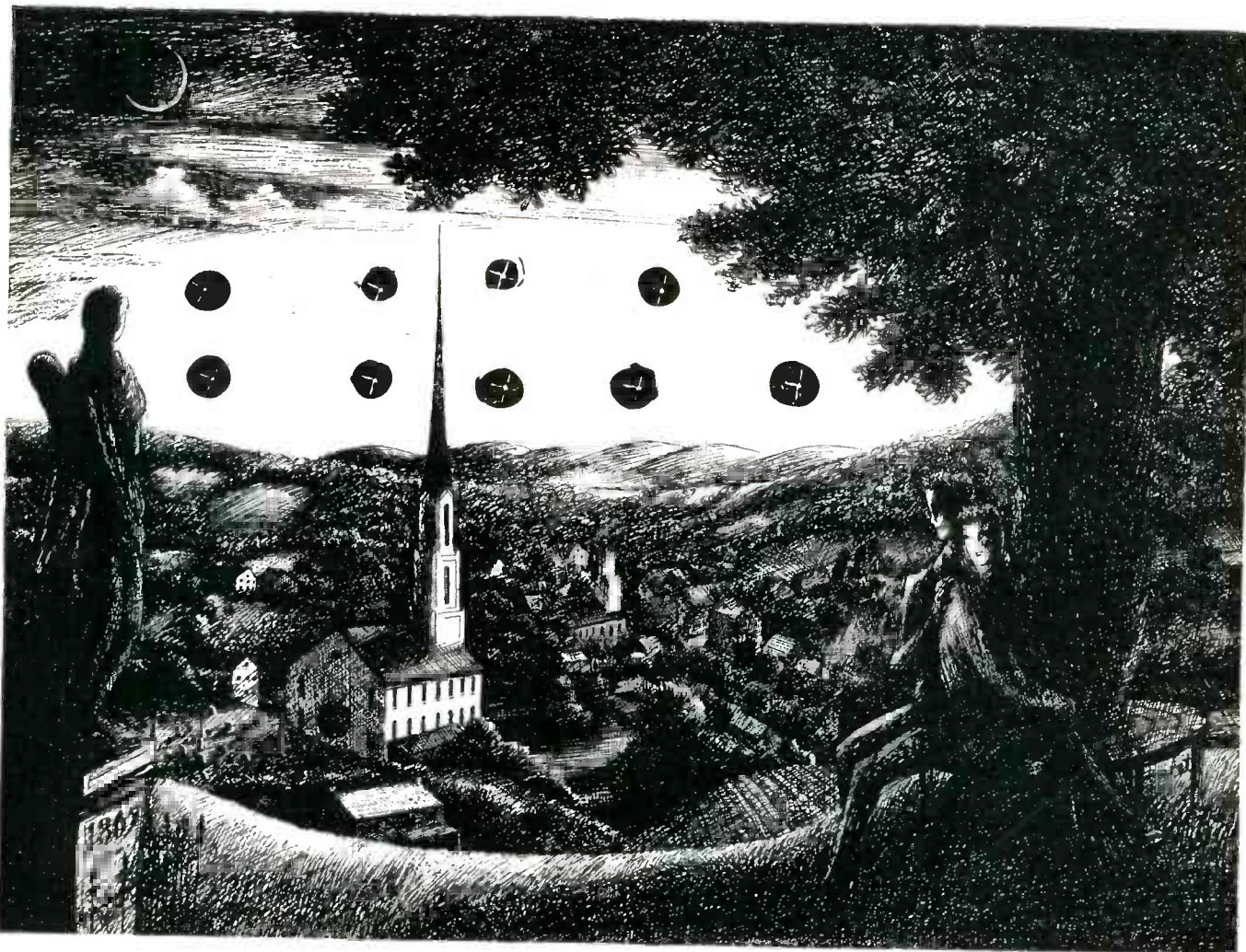

## The bells of Pleasant Valley

The story is told about the bells that ring in a little village in the foothills of the Alleghenies. In the Year of Our Lord 1865, the folk of Pleasant Valley created an inspiring memorial to their loved ones lost in the Civil War.

Into one mighty heap they piled the relics of the war's bitter battles. The old brass cannon, the battered muskets, the broken swords and rusted bayonets. They melted them all down, and from this litter of war the gentle bells of Pleasant Valley were cast, to ring out over green fields and fertile farms throughout the years of tranquillity and peace.

The time will come when something like that will happen to the mountainous litter of munitions for World War II. Olin Industries, too, will take their skill and knowledge and experience, their big stock pile of scientific research—all they have learned from fifty years of skillful operation through peace and war—and "melt them down" into things for peace. Instead of munitions for soldiers, there will be guns and ammunition for sportsmen. Instead of powder for bombs, there will be explosives for miners, farmers and

builders. Instead of carbines for soldiers, there will be roller skates for kids—and there will be brass, bronze and other metals for radios, refrigerators, irons—a thousand peace-time uses.

It will be a great day, when we can all "down tools" on the war job and pick up the tools for the job of peace once more. Then the songs of scores of machines making things to make life better, will be as joyful as the bells of Pleasant Valley.

OLIN INDUSTRIES, INC.,  
East Alton, Illinois



### *Divisions, Subsidiaries, Affiliates*

WINCHESTER REPEATING ARMS COMPANY • WESTERN CARTRIDGE COMPANY • WESTERN BRASS MILLS • BOND ELECTRIC CORPORATION • WESTERN POWDER MANUFACTURING COMPANY • GOVERNMENT OWNED OLIN OPERATED TACOMA ALUMINUM DIVISION • UNITED STATES CARTRIDGE COMPANY (OPERATING ST. LOUIS ORDNANCE PLANT) • LIBERTY POWDER COMPANY • EQUITABLE POWDER MANUFACTURING COMPANY • COLUMBIA POWDER COMPANY • EGYPTIAN POWDER COMPANY • TEXAS POWDER COMPANY



# New heights in rectifier performance...

## THE XENON FILLED 3B28

Ceramic Insulator protects anode seal.

Shield and element structure supported horizontally by glass bulb. Micro shock cushions absorb blows.

Glow discharge shield for maximum performance at high voltage.

Rugged spiral filament withstands extreme vibration.

Three heavy gauge supports clamped to stem resist shock; maintain exact electrode spacing.

Xenon gas fill gives mercury tube performance without restricted ambient temperature range. Tube operates in any position.

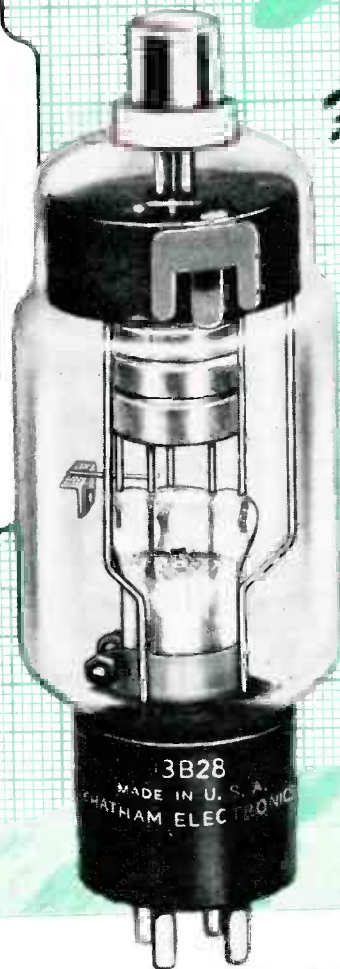
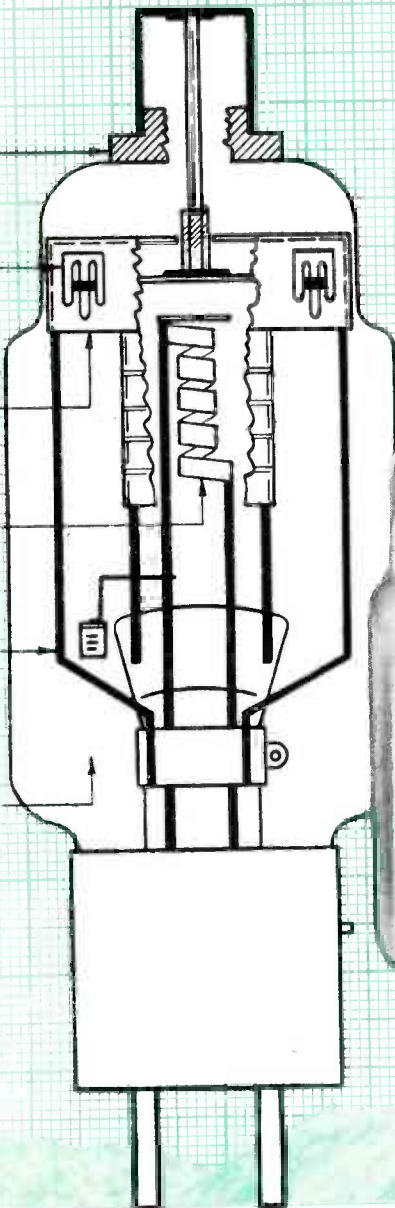

### Featuring:

1. PEAK INVERSE VOLTAGE 10,000 V.
2. AMBIENT TEMPERATURE RANGE  $-75^{\circ}\text{C.}$  to  $+90^{\circ}\text{C.}$
3. CONSTANT 10 VOLT DROP
4. OPERATES IN ANY POSITION
5. RUGGED, SHOCKPROOF CONSTRUCTION

Official U. S. Army photograph

Xenon gas fill endows this Chatham Electronic type 3B28 rectifier with the desirable features of both mercury vapor and high vacuum types. Simultaneously, the usual ambient temperature and current carrying limitations variously associated with the latter types are eliminated. For example, while plate current is heavy (2 amps. peak) the voltage drop is practically constant at 10 volts. Its maximum peak inverse voltage rating is 10,000 and normal functioning is assured through an ambient temperature range of  $-75^{\circ}$  to  $+90^{\circ}$  C.

The 3B28 is being widely utilized in many high voltage applications where extremes of ambient temperature, heavy current, severe shock and vibration are encountered. Small size permits ready adaption in mobile or airborne installations.

For further information, address inquiries to Department AE.



## CHATHAM ELECTRONICS

475 WASHINGTON STREET, NEWARK 2, NEW JERSEY

TECHNICAL DATA	UP TO 150 CPS	UP TO 500 CPS
Filament Voltage	2.5 VAC	2.5 VAC
Peak Inverse Volts	10 KV	6.5 KV
Peak Anode Current	1.0 A	2.0 A
Average Anode Current	250 MA	500 MA
Maximum Height	6.38 inches	
Maximum Diameter	2.07 inches	

### ▶ AUTOMATIC BEAM CONTROL . . .

Especially important in photographic recording. Beam intensity increased from zero during interval of useful left to right traversal when using single-sweep feature. Intensity automatically reduced to zero when time base is switched from recurrent to single-sweep operation, and returned to original intensity upon initiation of single sweep. For single-sweep use, the extinguishing of the beam except when it is actually plotting a curve, is a remarkable advance in commercial oscillograph design. Minimizes background light. No decrease of visible contrast of desired trace. Results in greatly increased contrast of photograph.

### ▶ TIME BASE WITH ASSURED LINEARITY . . .

Gas triode type. Extended frequency range: 1 sweep every 2 seconds to 50,000 per second. Single sweep if initiated repetitively, operates at writing rates corresponding to 0.5 to 10,000 c.p.s. Single-sweep action so designed that spot remains quiescent at right end of its traversal across screen until initiation by controlling signal, when it rapidly moves to left to assume starting position and then reverses its direction of motion to provide single-sweep across screen at a length of time determined by frequency control. One objection to a gas triode sweep circuit lies in non-linearity of sweep produced, especially at low-sweep rates. Overcome in Type 247 by use of a factory-adjusted compensated circuit which produces a nearly perfect linear sweep.

### ▶ SYNC LIMITER . . .

Time base generator may be synchronized to an external signal, power line or vertical axis signal by means of synchronizing selector switch. Limiting circuit maintains uniform sync regardless of sync signal input level. Synchronized by either positive or negative polarity of sync signal.

### ▶ TEST SIGNAL TERMINAL . . .

Furnishes either a test signal of line frequency at approximately 1 rms volt, or a sawtooth signal of sweep frequency at approximately 10 volts. Front-panel switch. Sawtooth signal available to drive external circuits. Provides modulated signal for FM systems.

### ▶ FUSED TRANSFORMER SECONDARIES . . .

Fuses placed in secondary windings for added protection of transformer, in addition to usual primary fuse. All fuses accessible for replacement without removing instrument from case.

© ALLEN B. DUMONT LABORATORIES, INC.

# Extra VALUES

found only in the

**DUMONT Type 247**

## Oscillograph

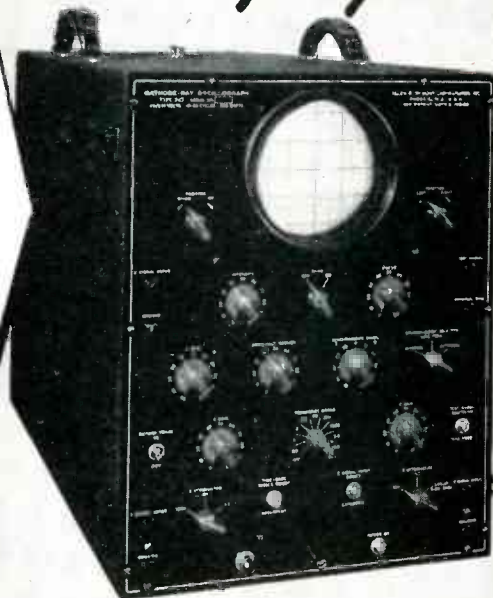

▶ Consider these extra values which are found in this instrument. For above and beyond the exceptional workmanship and the quality materials that do full justice to the well-planned mechanical design, the DuMont Type 247 oscillograph offers many electrical-performance features worthy of particular attention. A few are listed here.

▶ Detailed specifications on request.

# DUMONT

## Precision Electronics & Television

ALLEN B. DUMONT LABORATORIES, INC., PASSAIC, NEW JERSEY.

# First

## with **GRADE 1, CLASS 1 RESISTORS**

(First produced Dec. 1941—Millions made to date)

**First** with **RESISTORS WOUND with CERAMIC INSULATED WIRE**  
(Pioneered and perfected by Sprague many years ago)

**First** with **GLASS-TO-METAL SEALED RESISTORS** (Pioneered by Sprague in 1941, now produced commercially at the rate of thousands of seals per day)

**First** with **GLAZED CERAMIC SHELLS and New Style End Seals for 5-, 10-, 25-, 50- and 120-watt resistors.** (One type of Koolohm—the standard type—does the job under any climatic condition, anywhere in the world)

**First** and **STILL EXCLUSIVE with MEGOMAX**  
(The high-resistance, high-voltage resistors. Megohms of resistance operated at thousands of volts!)

One after another, Sprague Koolohm Resistors have established new performance records as proved indisputably by the record. One after another Koolohm Resistors have revolutionized traditional limitations to wire wound resistor usage—because radically different Koolohm construction permits a higher degree of physical protection, better electrical characteristics, smaller sizes, and easier mounting arrangements than are possible with conventional resistor types. Write for catalog.



# SPRAGUE KOOLOHM

(Trademark Reg. U. S. Patent Office)

## WIRE WOUND RESISTORS

**SPRAGUE ELECTRIC COMPANY**  
(Resistor Division) North Adams, Mass.

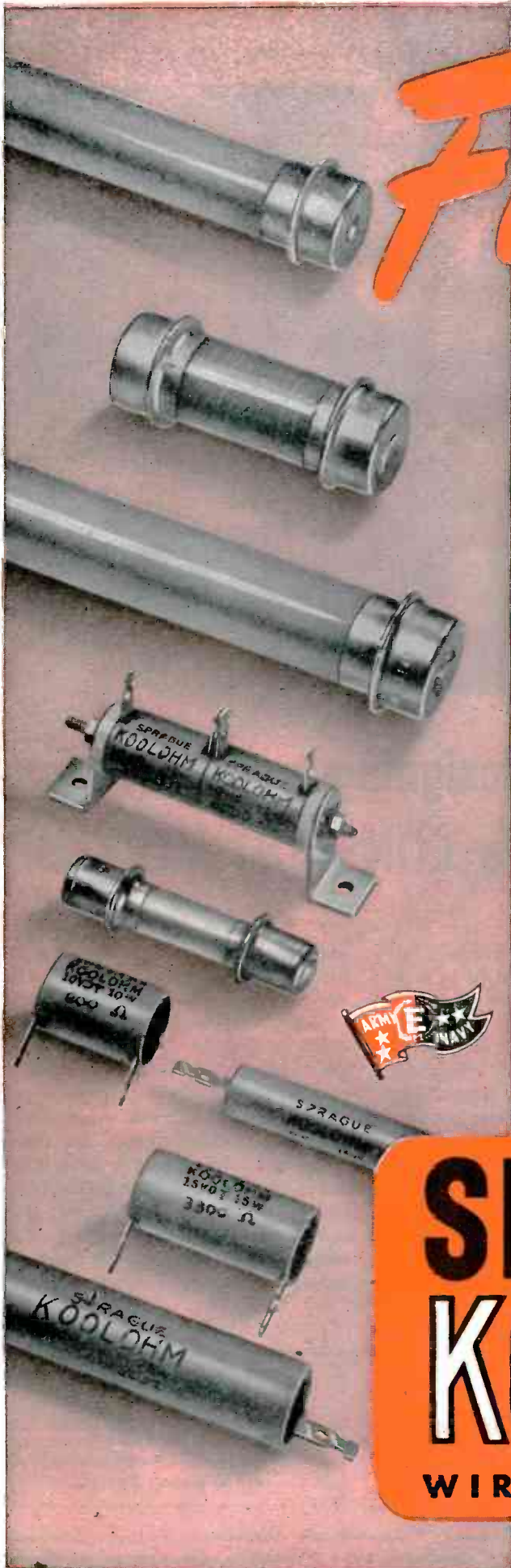

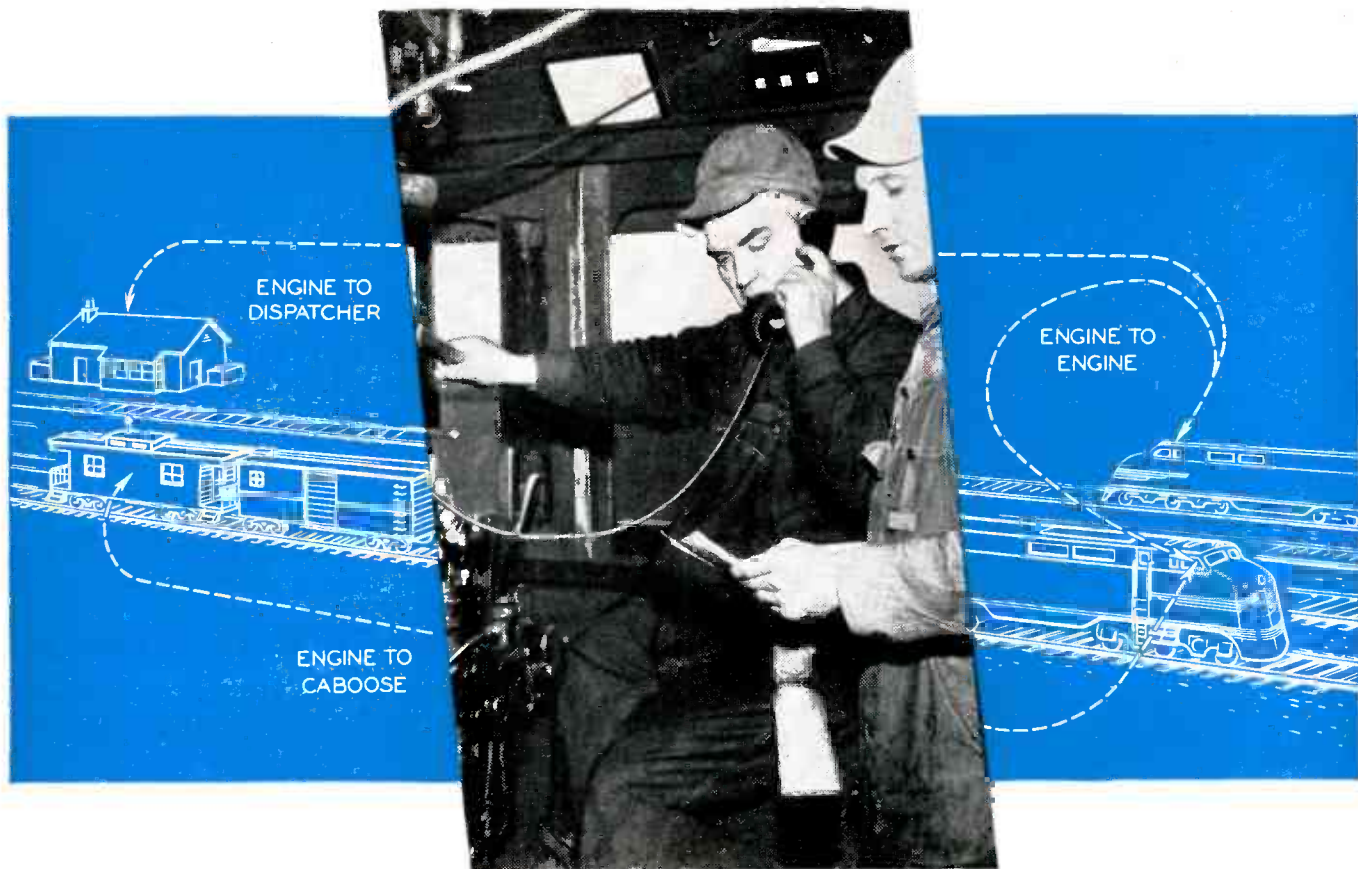

## The basic starting point in designing transportation communications equipment is **CONSTANT VOLTAGE**

With a calculated operating voltage, communications equipment can be designed to operate superbly in the laboratory.

But what happens when this equipment gets into the field where voltages may vary as much as 30% from the laboratory standard? Signals become indistinct and garbled and the life of costly tubes may be prematurely shortened.

The communications equipment now being designed to provide greater safety, greater efficiency in the operation of our rail, sea, air, bus

and truck transportation cannot fulfill this function if it is to rely on uncertain supply voltages. Constant voltage here is a "must".

SOLA Constant Voltage Transformers specially designed for communications equipment have been widely and successfully used before and during this war. They are the starting point in the basic design of much of the equipment now being planned for the major developments that are coming. Have you planned them into your equipment?

Consultation *now* with SOLA engi-

neers means better communications for the future. SOLA Constant Voltage Transformers are available in standard designs in capacities from 10VA to 15KVA. Or special units can be designed to meet any requirements. SOLA Constant Voltage Transformers require no supervision or manual adjustments. No networks or moving parts to get out of order. They protect both themselves and the equipment against short circuit. They are a practical and economical solution to ever present voltage problems.

# Constant Voltage Transformers

# SOLA

**To Manufacturers:**

*Built-in voltage control guarantees the voltage called for on your label. Consult our engineers on details of design specifications.*

**Ask for Bulletin DCV-102**

Transformers for: Constant Voltage • Cold Cathode Lighting • Mercury Lamps • Series Lighting • Fluorescent Lighting • X-Ray Equipment • Luminous Tube Signs • Oil Burner Ignition • Radio • Power • Controls • Signal Systems • etc. **SOLA ELECTRIC COMPANY, 2525 Clybourn Avenue, Chicago 14, Illinois**

## constant supervision by specialists

Although this operator has long been skilled in the winding of foil and tissue for Cornell-Dubilier capacitors, she looks to her supervisor for pointers when a new job is started. All along the line, production technique keeps pace with new improvements and innovations in our products.



Vigilance in little details is second-nature to C-D craftsmen.

Accuracy is their creed.

With such watchful care, capacitor-building becomes a precise science . . . a science that has earned for Cornell-Dubilier capacitors a world-wide reputation for quality and dependability.

If you have a capacitor problem, you may find the answer in one of our basic innovations in design, engineering or manufacture. Cornell-Dubilier Electric Corporation, So. Plainfield, N. J. Other plants: New Bedford, Brookline, Worcester, Mass., Providence, R. I.

### 170 TRANSMITTING CAPACITOR

Hermetically sealed in non-corrosive container. Compact, lightweight, furnished with universal mounting clamp, well-insulated terminals. Extra high dielectric strength. Wide range of voltage ratings.



# CORNELL - DUBILIER CAPACITORS



WET AND DRY ELECTROLYTICS • MICA • DYKANOL • PAPER •

# 6AK5

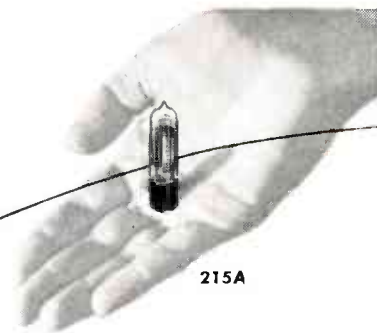

215A

## *the tube that grew out of a “peanut”*

When the returns are all in, many big scientific developments of World War II will be found to have roots deep in the past.

Certainly this is true of the revolutionary 6AK5 — developed by Bell Laboratories, and manufactured by Western Electric.

Back in World War I, these two organizations developed the 215A, so-called “peanut” tube; the first tube whose filament was powered by a single dry-cell. Down the years, research in electronics continued to give birth to new tubes which made “Western Electric” a synonym for performance and reliability. When the coaxial cable system was planned, with vacuum tube repeaters every few miles, the Laboratories developed the 386A tube. At the coming of war, the Bell Laboratories were

foremost in design of broadband amplifiers and of the vacuum tubes to make them work.

Indispensable for certain military equipment, the 386A was developed into the 717A tube, and still further refined in the 6AK5.

Besides producing 6AK5's in large quantities, Western Electric responded to emergency needs of the Army and Navy by furnishing design specifications and production techniques to other manufacturers. Today, at least five other companies are in quantity production.

The 6AK5 is another example of Bell Laboratories and Western Electric teamwork, which created many of the war's outstanding electron tubes. These tubes will play important peacetime roles in television and other arts of communication.



**BELL TELEPHONE LABORATORIES**

Exploring and inventing, devising and perfecting for our Armed Forces at war and for continued improvements and economies in telephone service.

***Western Electric***

Manufacturing team-mate of Bell Laboratories, and the country's largest producer of communications and electronic equipment for war.

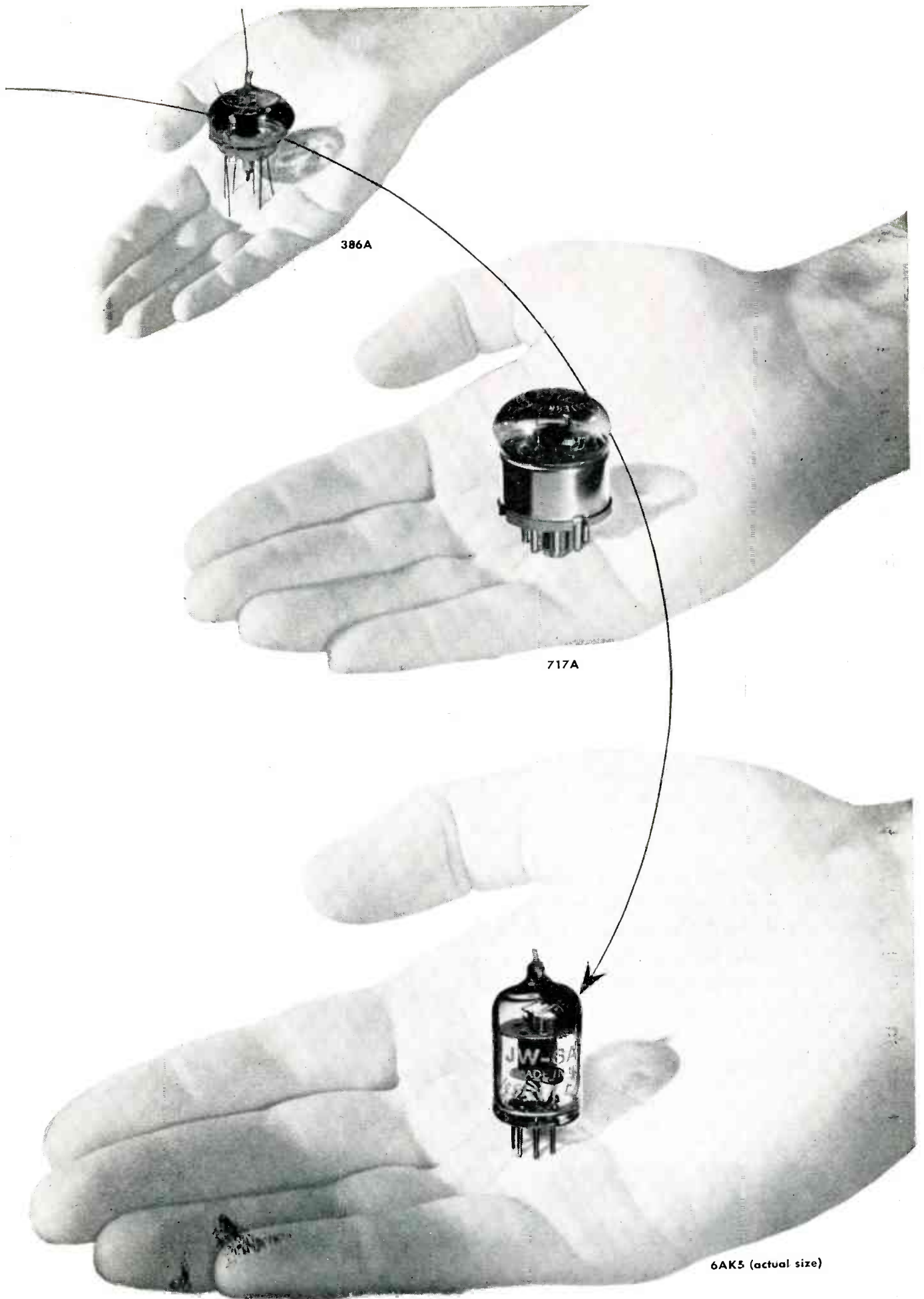

386A

717A

6AK5 (actual size)

# DOWN TO

# Fighting Weight

(Patent Applied for)

You don't measure efficiency with a ruler or scales. This one-ounce Sickles I. F. Transformer packs more improvements than you'd think could crowd into 1¼ cubic inches. The entire assembly is mechanically compact and exactly correlated for maximum electrical uniformity. Only four soldered joints in all, each one forming the connection of a single coil lead to a *fixed* terminal — no leads to vary coupling. Units can be supplied for operating frequencies up to 5.5 MC; tropicalized, if specified.

Minimum size with outstanding performance is demanded by our troops for their portable radio equipment. Here is Sickles' answer: a rugged little battler — down to "fighting weight" and ready for championship honors. Adaptable also to police and other mobile commercial applications.

THE F. W. SICKLES CO. • CHICOPEE, MASSACHUSETTS

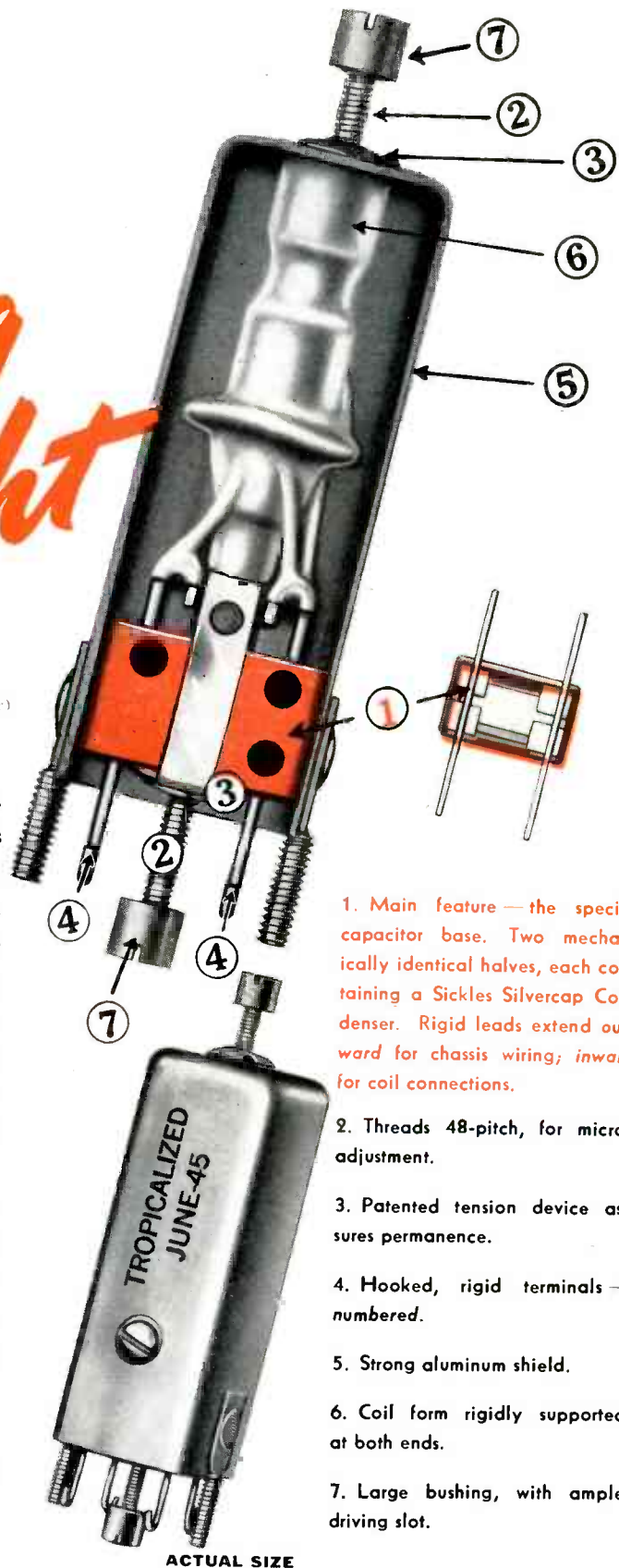

1. Main feature — the special capacitor base. Two mechanically identical halves, each containing a Sickles Silvercap Condenser. Rigid leads extend outward for chassis wiring; inward for coil connections.

2. Threads 48-pitch, for micro-adjustment.

3. Patented tension device assures permanence.

4. Hooked, rigid terminals — numbered.

5. Strong aluminum shield.

6. Coil form rigidly supported at both ends.

7. Large bushing, with ample driving slot.

ACTUAL SIZE

# SICKLES

*Radio and Electronic Specialties for Today and Tomorrow*





# TWO NEW GASEOUS VOLTAGE REGULATORS

## *In Miniature*



The list of Hytron's customers for the standard OC3/VR105 and OD3/VR150 reads like the social register of electronics. Proved quality products, these Hytron tubes are found literally by the millions in military radar, communications, and electronic equipment.

Now in space-saving miniature bulbs, the new Hytron OA2 and OB2 offer the same careful engineering design, rigid control of processing and assembly, and adherence to tight factory specifications which have made the standard Hytron regulators famous. Life and performance of the miniature OA2 and OB2 equal those of the standard tubes, except that maximum operating current is 30 ma. for the miniatures. Construction is both simple and rugged. Note, for example, use of both top and bottom mica supports and the heavy stem leads. Compare the characteristic data given. Consider the possible space economies. Order your engineering samples today.

### COMPARATIVE DATA

#### HYTRON MINIATURE AND STANDARD GASEOUS VOLTAGE REGULATOR TUBES

TYPE	PHYSICAL CHARACTERISTICS				AVERAGE OPERATING CONDITIONS			
	Max. Length (inches)	Max. Diam. (inches)	Bulb	Base	Supply Voltage† (min.)	Operating Voltage (approx.)	Regulation $E_{50} - E_{30}$ ‡ (volts)	Operating Current* (ma.)
OA2	2 5/8	3/4	T-5 1/2	7-pin Min.	185	150	2	5-30
OD3/VR150	4 1/8	1 1/8	ST-12	6-pin Octal				5-40
OB2	2 5/8	3/4	T-5 1/2	7-pin Min.	133	108	1	5-30
OC3/VR105	4 1/8	1 1/8	ST-12	6-pin Octal				5-40

†Sufficient resistance must always be used in series with the tube to limit current through it as follows: OA2 and OB2, 30 ma.; OD3/VR150 and OC3/VR105, 40 ma.

‡Regulation (either positive or negative polarity) is defined as the difference in voltage when the current is varied from 5 ma. to 30 ma.

\*Operation for extended periods of time at low current will temporarily increase regulation of tube.

OLDEST MANUFACTURER SPECIALIZING IN RADIO RECEIVING TUBES



# HYTRON

RADIO AND ELECTRONICS CORP.



BUY  
ANOTHER  
WAR BOND

MAIN OFFICE: SALEM, MASSACHUSETTS  
PLANTS: SALEM, NEWBURYPORT, BEVERLY & LAWRENCE

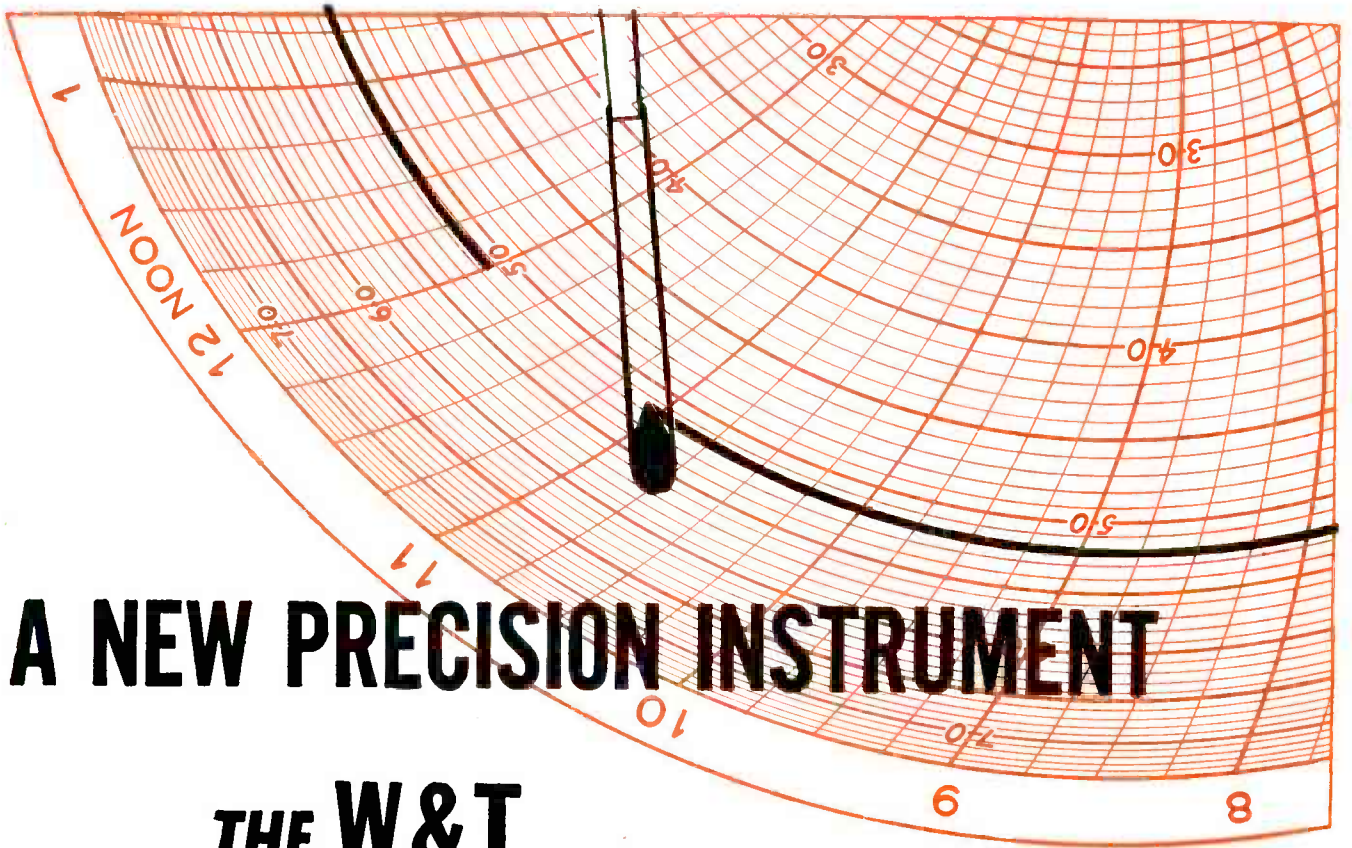

# A NEW PRECISION INSTRUMENT

## THE W&T

### VACUUM and PRESSURE REGULATOR

Pressure or vacuum systems under normal laboratory test conditions can be maintained at set pressure with no readable deviation when controlled with the new W&T Constant Vacuum and Pressure Regulator.

Manually adjustable over a range of 27 inches of mercury vacuum to 31.5 inches of mercury pressure, the Regulator automatically compensates for variation in the vacuum or pressure source and for changes in barometric pressure.

This precision control of a pressure system is especially valuable in instrument calibration and other controlled-pressure inspection and test work.

Write today for Technical Publication 257 describing this new tool for research and industry.



**WALLACE & TIERNAN**  
**PRODUCTS, INC.**



**BELLEVILLE 9**

**NEW JERSEY**

A-50

# SELECTOR MECHANISMS



## DEVELOPMENT INGENUITY

Development ingenuity—the skill in improving or combining—plays an ever increasing role in Selector Mechanisms produced by Santay.

Santay's development engineering staff is composed of proven producers, who devise new mechanisms to answer a specific problem; engineers who are artisans in the use of metal working tools. They develop the basic design, incorporating to the highest possible degree: 1. economy of manufacturing, 2. reliability of operation and 3. accuracy of the mechanism. Final developed designs reflect an ease of manufacturing that permits Santay to meet stringent delivery schedules if necessary.

INJECTION MOLDING • METAL STAMPING • ELECTRO-MECHANICAL ASSEMBLIES

## DESIGN ABILITY



## MANUFACTURING FACILITIES



## DESIRE TO SERVE

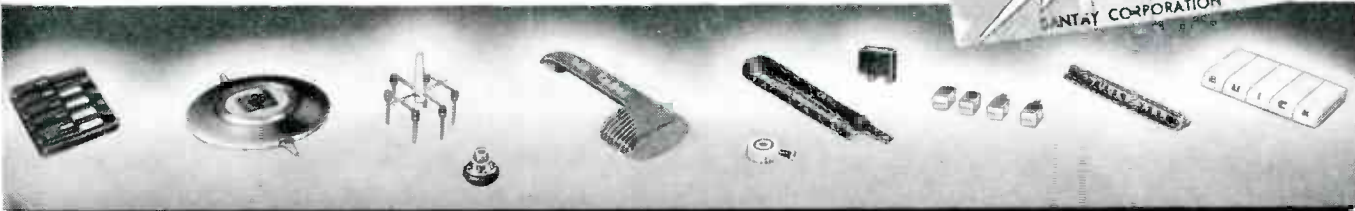
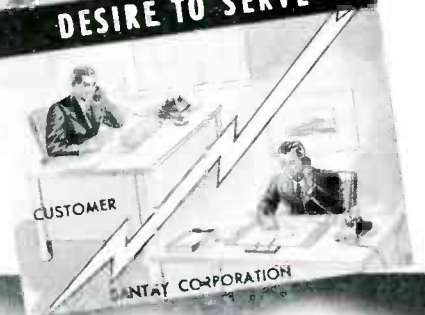

**SANTAY CORPORATION, 353 NORTH CRAWFORD AVE., CHICAGO 24, ILLINOIS**

REPRESENTATIVES: POTTER & DUGAN, INC., 29 WILKESON STREET, BUFFALO 2, NEW YORK • PAUL SEILER, 7779 CORTLAND AVENUE, DETROIT 4, MICHIGAN • QUEISSER BROS., 110 E. NINTH STREET, INDIANAPOLIS 2, INDIANA



### TROUBLE CHASER!

Even though carefully hand driven, and then smoothed up, slotted screws spelled trouble for this well-known typist's chair manufacturer. Some burrs got by inspectors, snagged steno's stockings.



### OUTPUT PACER!

But burrs became a memory when he switched to Phillips Recessed Head Screws. Better still, workers, freed of the dangers of finish-scarring driver skids, boosted output plenty with fast power-driving.



### FUTURE FACER!

Because they are engineered to take top driving pressures, Phillips Screws help designers improve product strength and rigidity. With stronger, tighter fastenings, any product is in better shape to meet coming competition.

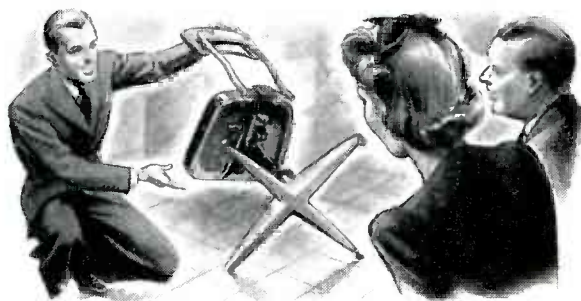

### ORDER PLACER!

At the point-of-sale, the Phillips Recess' eye-appeal will help to get the order. Burr-free, blending with any product's beauty - it's the finishing touch that softens the toughest prospects!

# It's Phillips <sup>1111</sup> the engineered recess!



In the Phillips Recess, mechanical principles are so correctly applied that every angle, plane, and dimension contributes fully to screw-driving efficiency.

... It's the exact pitch of the angles that eliminates driver skids.

... It's the engineered design of the 16 planes that makes it easy to apply full turning power - without reaming.

... It's the "just-right" depth of recess that enables Phillips Screw Heads to take heaviest driving pressures.

With such precise engineering, is it any wonder that Phillips Screws speed driving as much as 50% - cut costs correspondingly?

To give workers a chance to do their best, give them faster, easier-driving Phillips Recessed Head Screws. Plan Phillips Screws into your product now.

## PHILLIPS *Recessed Head* SCREWS

WOOD SCREWS • MACHINE SCREWS • SELF-TAPPING SCREWS • STOVE BOLTS

Made in all sizes, types and head styles

**25 SOURCES**

American Screw Co., Providence, R. I.  
Atlantic Screw Works, Hartford, Conn.  
The Bristol Co., Waterbury, Conn.  
Central Screw Co., Chicago, Ill.  
Chandler Products Corp., Cleveland, Ohio  
Continental Screw Co., New Bedford, Mass.  
The Corbin Screw Corp., New Britain, Conn.  
General Screw Mfg. Co., Chicago, Ill.

The H. M. Harper Co., Chicago, Ill.  
International Screw Co., Detroit, Mich.  
The Lamson & Sessions Co., Cleveland, Ohio  
Manufacturers Screw Products, Chicago, Ill.  
Milford Rivet and Machine Co., Milford, Conn.  
The National Screw & Mfg. Co., Cleveland, Ohio  
New England Screw Co., Keene, N. H.  
Parker-Kalon Corp., New York, N. Y.  
Pawtucket Screw Co., Pawtucket, R. I.

Pheoll Manufacturing Co., Chicago, Ill.  
Reading Screw Co., Norristown, Pa.  
Russell Burdall & Ward Bolt & Nut Co., Port Chester, N. Y.  
Scovill Manufacturing Co., Waterville, Conn.  
Shakeproof Inc., Chicago, Ill.  
The Southington Hardware Mfg. Co., Southington, Conn.  
The Steel Company of Canada Ltd., Hamilton, Canada  
Wolverine Bolt Co., Detroit, Mich.

# COMMUNICATIONS

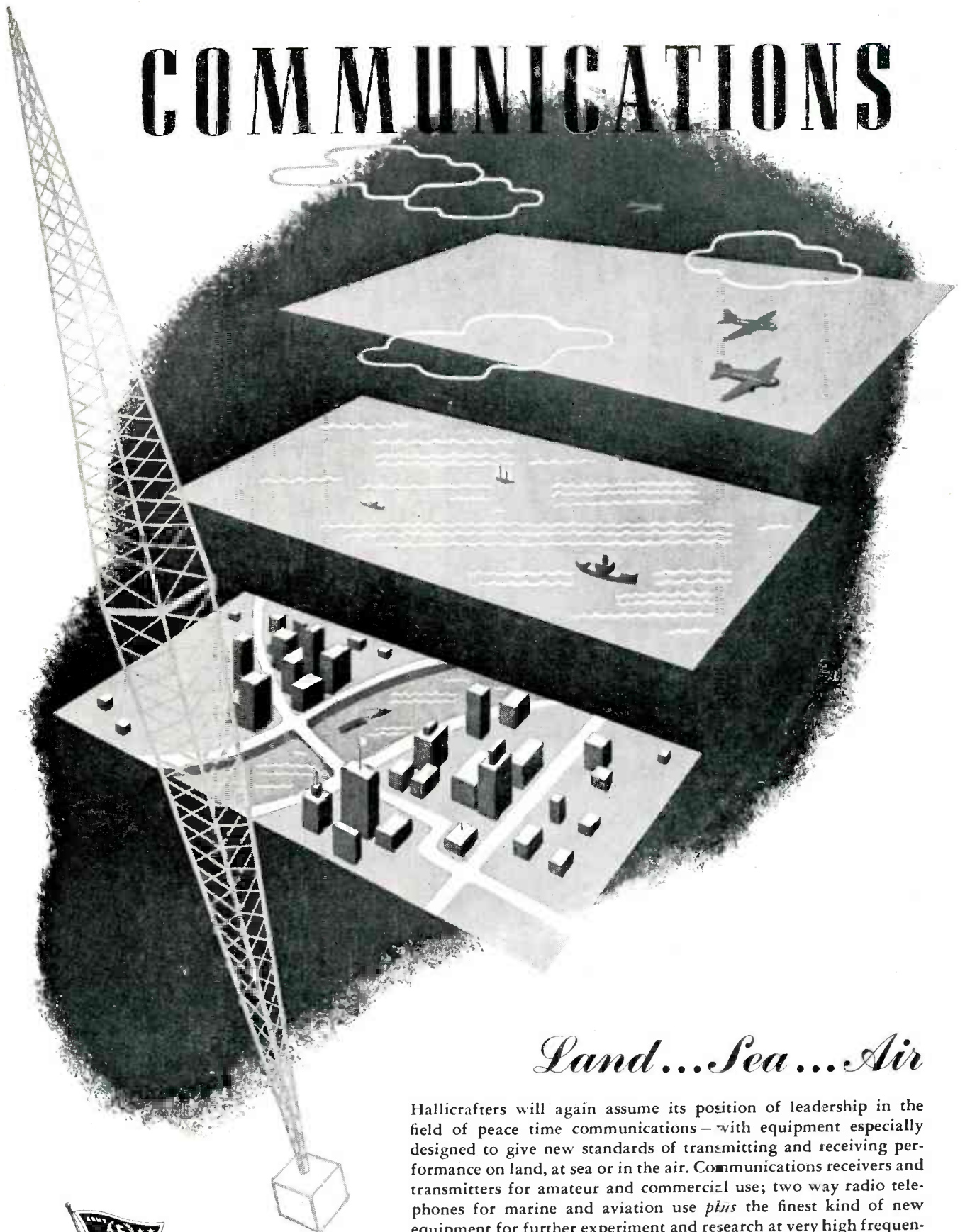

## *Land...Sea...Air*

Hallicrafters will again assume its position of leadership in the field of peace time communications — with equipment especially designed to give new standards of transmitting and receiving performance on land, at sea or in the air. Communications receivers and transmitters for amateur and commercial use; two way radio telephones for marine and aviation use *plus* the finest kind of new equipment for further experiment and research at very high frequencies will all be included in Hallicrafters postwar production plans.



BUY A WAR  
BOND TODAY!

COPYRIGHT 1945  
THE HALCRAFTERS CO.

## hallicrafters RADIO



THE HALCRAFTERS CO., WORLD'S LARGEST EXCLUSIVE MANUFACTURERS OF SHORT WAVE RADIO COMMUNICATIONS EQUIPMENT, CHICAGO 16, U. S. A.



## "I like to know how I'm doing

*... and a Presto recording  
tells me frankly!"*

"A Presto recording is my severest critic," says Hildegard, radio's fabulous singing star. "I have each of my Raleigh Cigarette programs transcribed so that after the show I can check my voice and delivery. When you use Presto equipment—with its accurate reproduction and fidelity to musical tones—you know you're getting the truth!"

Major broadcasting stations all over the country have found that Presto produces high quality work—consistently. What's more, busy recording studios know that Presto equipment can take it, year in and year out, and still remain in perfect operating condition over long periods without adjustment. For every Presto unit is a precision instrument embodying fine materials and workmanship and the highest operating skill. Write for complete information.



# PRESTO

**RECORDING CORPORATION**

242 West 55th Street, New York 19, N. Y.

*Walter P. Downs, Ltd., in Canada*

**WORLD'S LARGEST MANUFACTURER OF INSTANTANEOUS SOUND RECORDING EQUIPMENT AND DISCS**

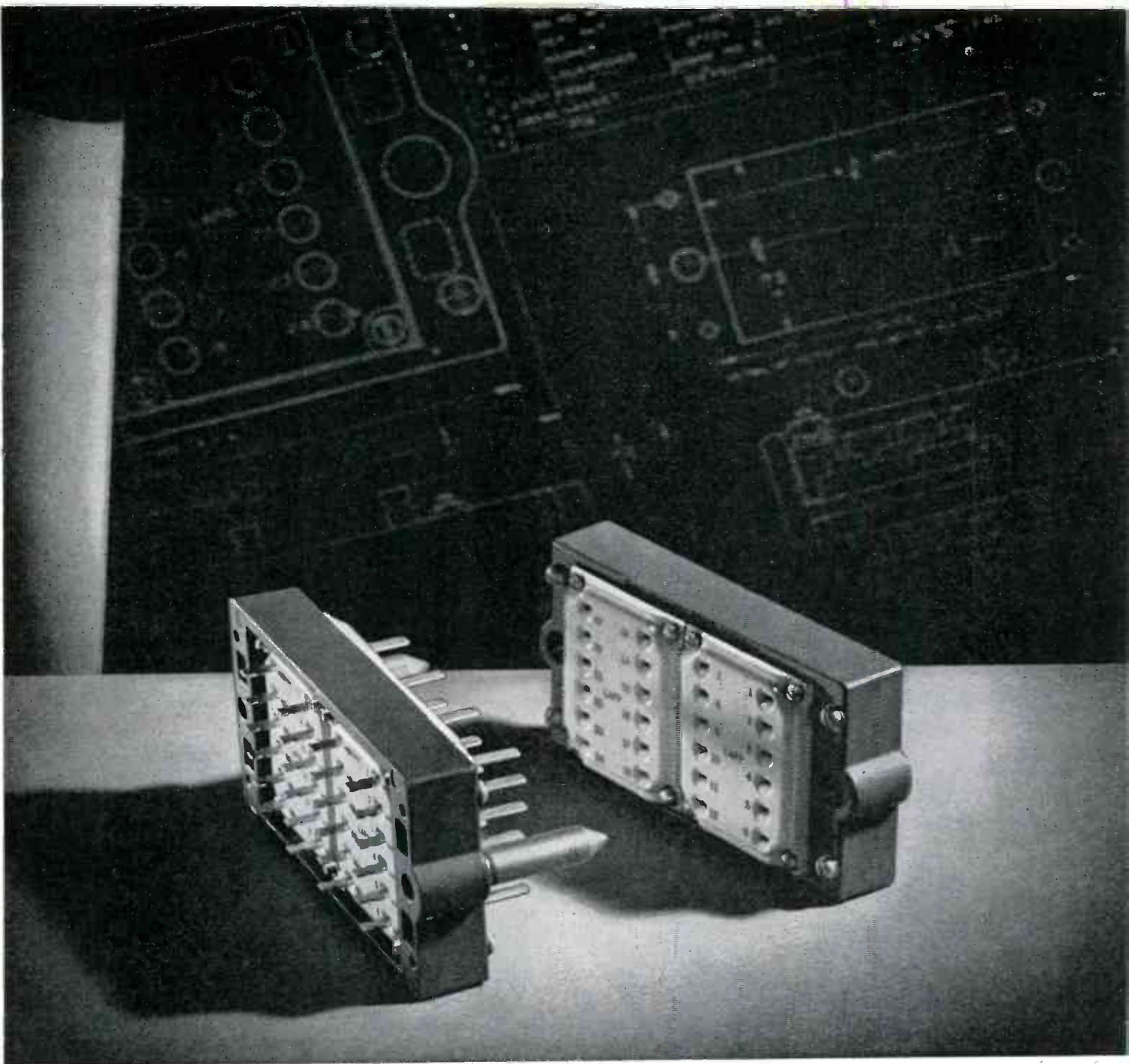

## *An Electronic Part* ... ENGINEERED TO A SPECIFIC NEED

This is a special-purpose electronic part. It is a plug-receptacle assembly for use with rack-panel type of mounting. Twenty-four silver-plated phosphor-bronze contacts are provided, each male and female contact full floating between steatite plates. Heavy guide pins and matching holes in the frame assure perfect alignment.

We don't know that your product has any need for such a part as this. We do know, however, that this part is most exactly suited to its special requirement just as are hundreds upon hundreds of other parts which have been created through Lapp engineering and Lapp production facilities directed to the solution of specific problems.

With a broad basic knowledge of ceramics—their capabilities and their limitations—Lapp has been able to simplify and to improve many types of elec-

tronic equipment through engineering and production of sub-assemblies that make most efficient use of porcelain or steatite and associated metal parts.

There may be a way you can improve performance, cut costs and cut production time through use of Lapp-designed and Lapp-built sub-assemblies. We'd like to discuss your specific requirements with you.  
*Lapp Insulator Co., Inc., LeRoy, N. Y.*



# TYPES 274-A and 274-B FULL WAVE, HIGH VACUUM RECTIFIERS

by

**E-E**



Ruggedly designed, these E-E Rectifiers are suitable for portable and industrial applications.



Made in many types and capacities; these high vacuum units offer noise-free current supply.

*..post-war problem solvers!*

Fundamentally, these E-E electronic tubes are representative of the research and engineering being projected into the industry's war effort. Basically, however, they are indicative of much more. For in the future, they hold great promise of material economies and advancements.

Industrial control, guidance, sorting, counting, indicating, detecting, protecting, etc., are but a few of the functions which will be undertaken by E-E 274-A and 274-B vacuum tubes. With ratings substantially higher than RMA 80, these tubes are recommended when higher DC currents are required. The two tubes are identical except for bases. Extensive in application, these high vacuum rectifiers widen the possibilities of potential uses, and draw closer the horizons of actuality, tomorrow. E-E Data Book on request.



**ELECTRONIC ENTERPRISES, INC**

65-67 SEVENTH AVENUE, NEWARK 4, NEW JERSEY



# METAL ASSEMBLIES AND COMPONENTS FOR ELECTRONIC AND MECHANICAL DEVICES

•  
**ENGINEERING**

•  
**DEVELOPING**

•  
**FABRICATING**

•  
**ELECTRO-FORMING**

•  
**PLATING**

•  
**FINISHING**  
•

**B**ERNARD **R**ICE'S **S**ONS

I N C O R P O R A T E D

MANUFACTURERS OF QUALITY METAL PRODUCTS SINCE 1867

OFFICE: 325 FIFTH AVENUE, NEW YORK 16, N. Y.

WORKS: 139-145 NORTH TENTH STREET, BROOKLYN 11, N. Y.

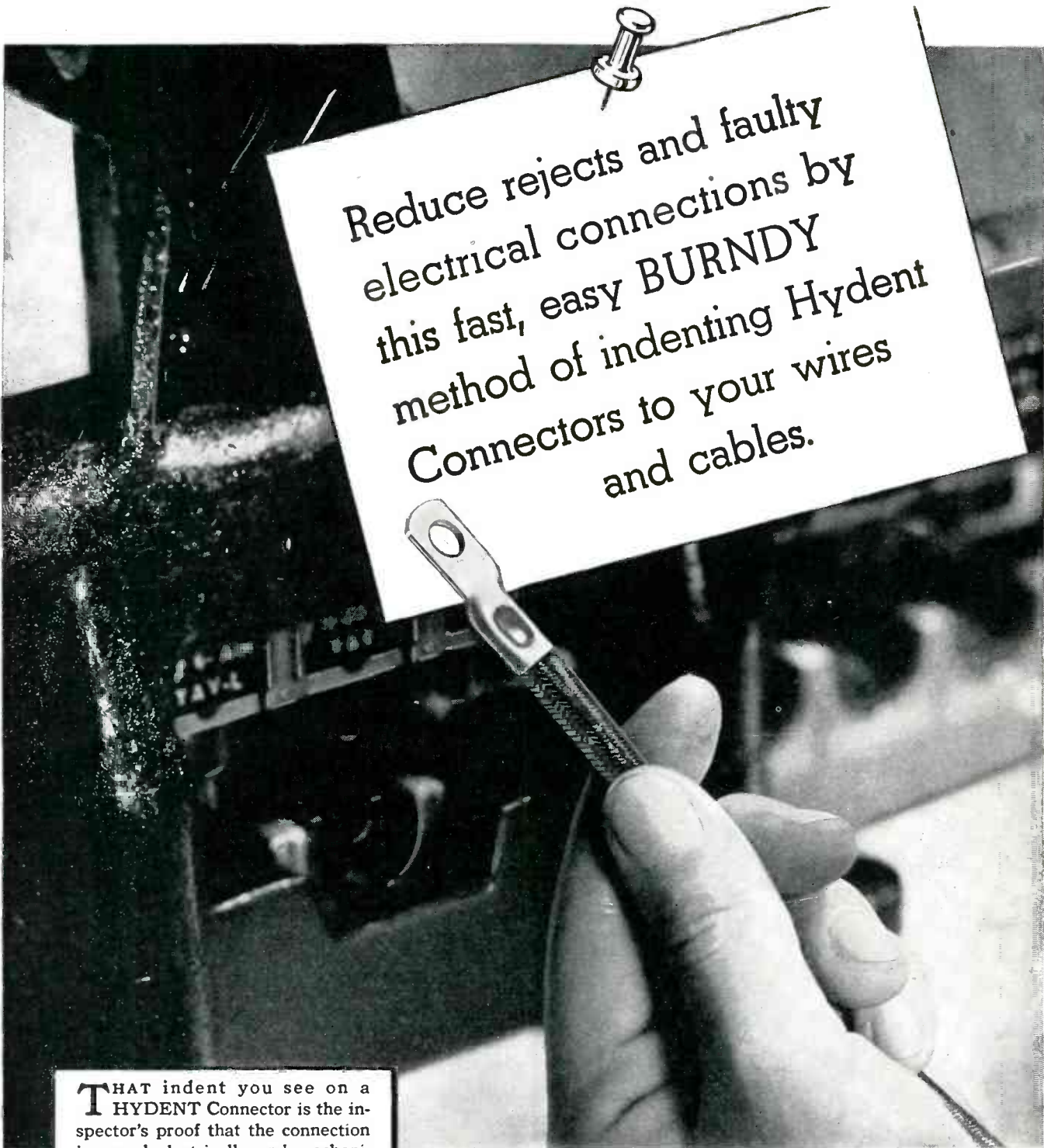

Reduce rejects and faulty electrical connections by this fast, easy BURNDY method of indenting Hydent Connectors to your wires and cables.

**T**HAT indent you see on a HYDENT Connector is the inspector's proof that the connection is sound electrically and mechanically. These connectors are of one-piece construction, and the depth of indent is accurately controlled by the automatic HYPRESS. In addition, the simplicity of attaching HYDENT Connectors cuts both time and cost as much as 50%. Operators can attach as many as 500 or more an hour. Connectors and indenting tools of the proper type and size are available to suit your production needs. Let us send you the details. Write Burndy Engineering Co., Inc., 107-L Bruckner Boulevard, New York 54, N. Y.

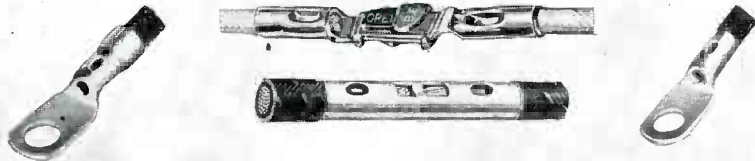

Headquarters for  
CONNECTORS

# Burndy



# Need Solutions TO PROBLEMS LIKE THESE

- Lamp Base Lubrication (Life Tests)
- Resistance Manufacture
- Non-Smoking, Non-Staining Lubricant for Glassworking Tools
- Bleeding of Static (Driving Belts, etc.)
- Assembly Lubricant (Radio Mechanisms)

**A**N increasing number of men in the electronics industries have successfully employed "dag" dispersions of colloidal graphite to help cure difficult problems like those above. There are 18 different "dag" products, some of them brand new, which together represent a versatility it will pay you to investigate. The folder above (No. 440) lists these dispersions and discusses briefly the nature and uses of each. Other new booklets, listed below, go into greater detail. All are free.

## **dag** colloidal graphite

ACHESON COLLOIDS CORPORATION, Port Huron, Michigan

### TO GET THESE:

This new literature on "dag" colloidal graphite is yours for the asking:

- 430** A general booklet on the story of "dag" colloidal graphite. 12 pages profusely illustrated.
- 440** A complete list of "dag" colloidal graphite dispersions with applications.
- 421** "dag" colloidal graphite for ASSEMBLING AND RUNNING-IN ENGINES AND MACHINERY.
- 422** "dag" colloidal graphite as a PARTING COMPOUND.
- 423** "dag" colloidal graphite as a HIGH TEMPERATURE LUBRICANT.
- 431** "dag" colloidal graphite for IMPREGNATION AND SURFACE COATINGS.
- 432** "dag" colloidal graphite in the FIELD OF ELECTRONICS.

### MAIL THIS:

JML Co. A-H1

ACHESON COLLOIDS CORPORATION  
PORT HURON, MICHIGAN DEPT. H-5

Please send me, without obligation, a copy of each of the bulletins checked:

No. 430  NAME \_\_\_\_\_

No. 440  POSITION \_\_\_\_\_

No. 421  FIRM \_\_\_\_\_

No. 422  ADDRESS \_\_\_\_\_

No. 423  ZONE No. \_\_\_\_\_ STATE \_\_\_\_\_

No. 431  OUR PRESENT OIL SUPPLIER IS \_\_\_\_\_

No. 432  (Lubricants containing "dag" colloidal graphite are available from major oil companies.)

# YOURS!

*Just write us, on your letterhead, for your copy of this valuable booklet on permanent magnets*

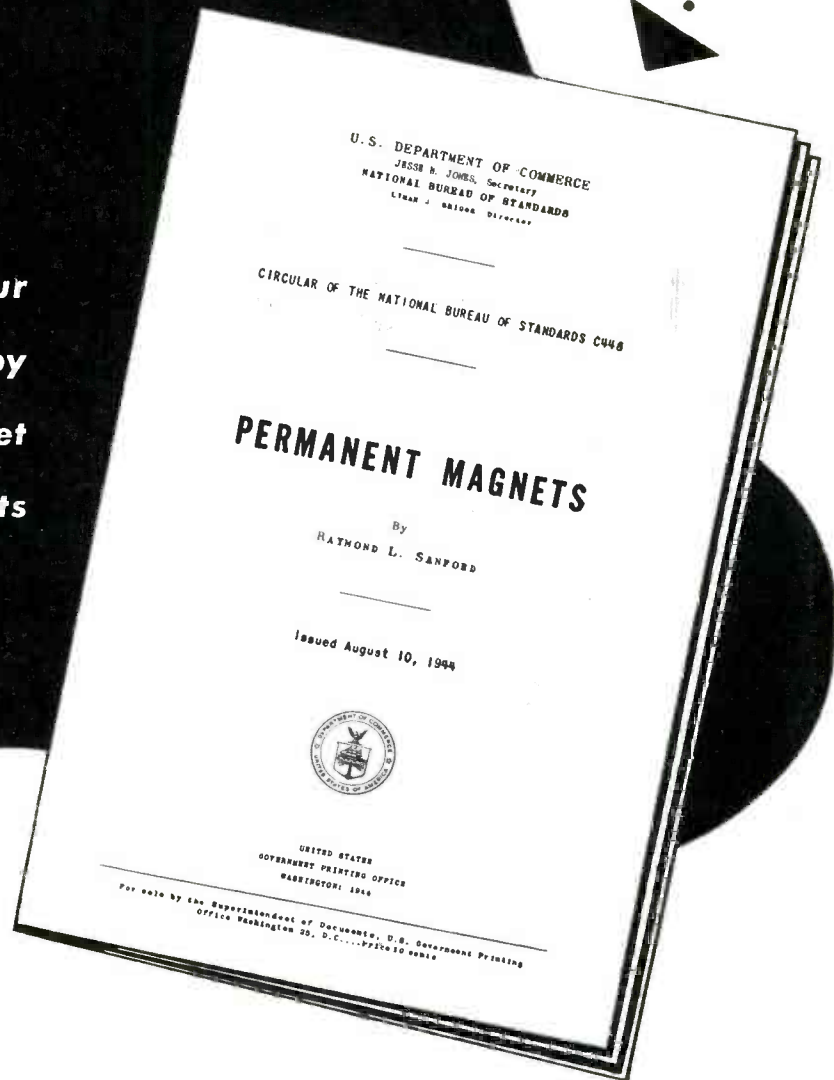

● As a service to industry, The Arnold Engineering Company is "lending a hand" in the distribution of what Arnold engineers believe to be a very informative study on the subject of permanent magnets.

This 39-page book of permanent magnet theory, design data and references was published by the government. Arnold is pleased to make it available to you free of charge and without obligation. Write for it today!



## THE ARNOLD ENGINEERING COMPANY

147 EAST ONTARIO STREET, CHICAGO 11, ILLINOIS

*Specialists in the Manufacture of ALNICO PERMANENT MAGNETS*

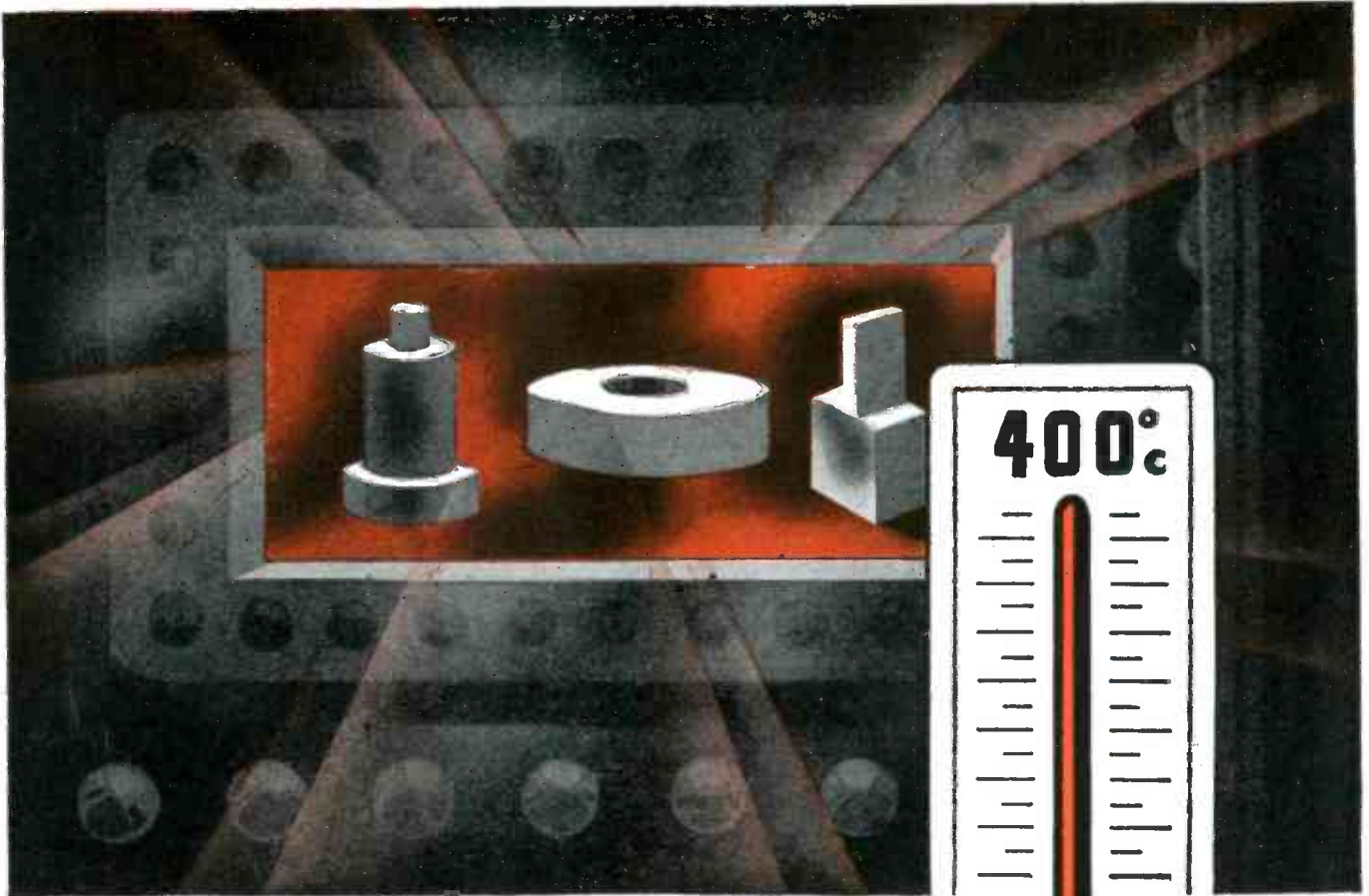

# MYCALEX 400

## WITHSTANDS HIGH TEMPERATURES

An outstanding characteristic of MYCALEX 400 is that it can withstand temperatures above 400° C. without softening or any permanent change in dimensions or properties.

Thus MYCALEX 400 has proved of great value as a low loss insulator in communications and other high frequency apparatus intended for use at elevated operating temperatures.

MYCALEX 400 is inorganic, free of carbonization... impervious to oil and water... not subject to cold flow. It meets all Army and Navy specifications as Grade L-4 material (JAN-I-10). It combines low loss factor with machinability to close tolerances. In sheets and rods. Fabricated to specifications.



### OTHER MYCALEX CORPORATION PRODUCTS

#### MYCALEX K

A series of ceramic capacitor dielectrics, with dielectric constant selectable from 8 to 19. Low power factor, high dielectric strength. Meets Army and Navy requirements as Class H material (JAN-I-12). To specifications.

#### MOLDED MYCALEX

Low loss, high temperature injection molded insulation. Molded in union with metals in irregular shapes. High production rates result in economical prices.

MYCALEX K and MOLDED MYCALEX will also withstand 400° C.

# MYCALEX CORPORATION OF AMERICA

"Owners of 'MYCALEX' Patents"

Plant and General Offices, CLIFTON, N. J.

Executive Offices, 30 ROCKEFELLER PLAZA, NEW YORK 20, N. Y.

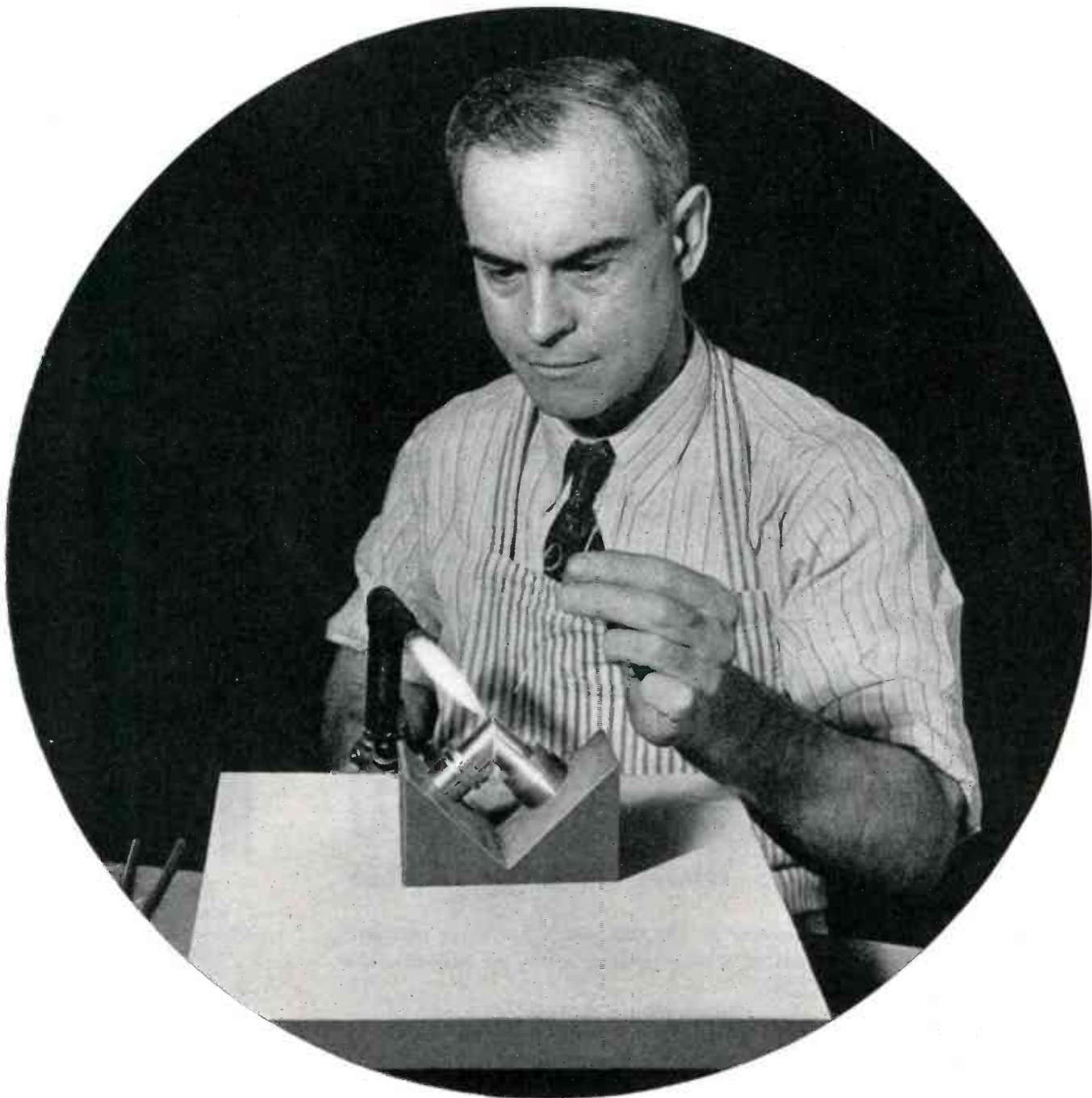

**CONNECT** your postwar production to DICO for precision equipment, instruments, and manufactures, completed in accordance with the most exacting specifications in the field of radio and electronics. And also to DICO's product engineering, designing, and development; since nothing like them in skill, experience, and effectiveness will exist in a nearly sufficient volume to meet the needs of industry after the war. Take your requirements up with DICO now; you can thus assure yourself, in the future, the advantages of its exceptional facilities. Your inquiry will bring a prompt reply.

☐ *Product engineering, machining, gold and silver plating, casting, soldering, assembling, finishing.*



"SURE CURE  
FOR CHILLS  
OR FEVER"

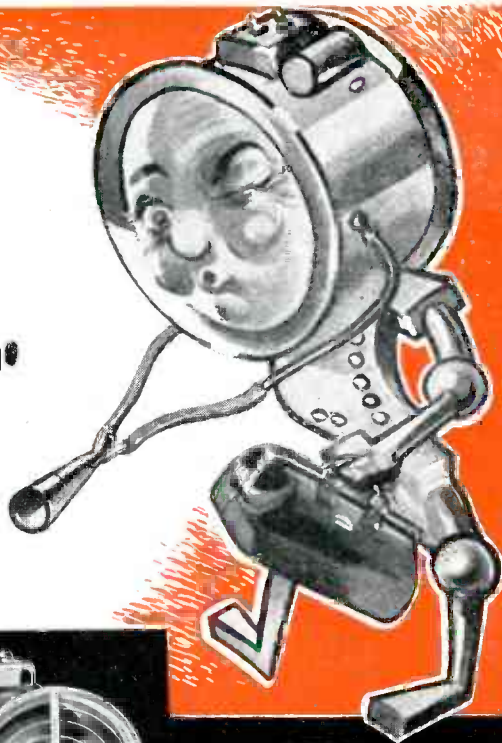

1921-C — Delivers 15 CFM @ .4" S.P., 12,500 RPM. Overall length 4"; diameter 2-3/4"; weight 7 oz. (1/500 HP).

2881-A — Delivers 50 CFM @ .6" S.P., 9400 RPM. Overall length 4-1/8"; diameter 3-3/4"; weight 18 oz. (1/100 HP).

4581-A — Delivers 180 CFM @ 1" S.P., 7500 RPM. (1/12 HP). Overall length 6-7/16"; diameter 5-3/4"; weight 4 lbs. 2 oz.

5861-C — Delivers 400 CFM @ 1" S.P., 6300 RPM. (1/10 HP). Overall length 6-7/16"; diameter 7-1/16"; weight 3 lbs. 4 oz.

121 — Delivers from 1400 CFM @ .4" S.P. at 1750 RPM to 4300 CFM @ 7" S.P. at 7200 RPM for belt or direct drive, also available with built-in 3-phase motor. Overall length 10-1/2"; diameter 15".

## DYNAMIC AIR AXIAL FLOW BLOWERS

... save weight, space and power input  
... deliver more air against high pressures\*

Whether you want just a breath of air movement to cool a tiny hot spot, or a gale for ventilation — hot or cold — there's a Dynamic Air Axial Flow Blower that will do it quicker and better. Here's why —

1. They save 2/3 the space required by bulky, old fashioned, centrifugal blowers.
2. They weigh less than 1/2 as much as the old fashioned types.
3. Much less power input is required for a specified amount of air delivery.

All of these advantages are the direct result of the direct air flow that is possible only with axial flow.

Based on 14 years of development, Dynamic Air Axial Flow Blowers represent the most advanced application of this principle. They bring you great possibilities for air engineering against static pressures as high as 10" or more W.G.

All are designed to rigid performance and weight specifications. Adaptations can be made to the most precise requirements. Consult us about your blower problem.

\*In addition to the typical models shown, many others are available in single and two stage ratings up to 100,000 CFM @ 10" S.P., with motors in standard voltages and cycles. You'll find the one you need in the Dynamic line.

**DYNAMIC AIR ENGINEERING**  
LOS ANGELES, U. S. A. *Mc.*  
DESIGNERS and BUILDERS of HIGH EFFICIENCY AXIAL FLOW EQUIPMENT

# WILCO

## NOW EQUIPPED

for large scale production of

# JACKETED WIRE

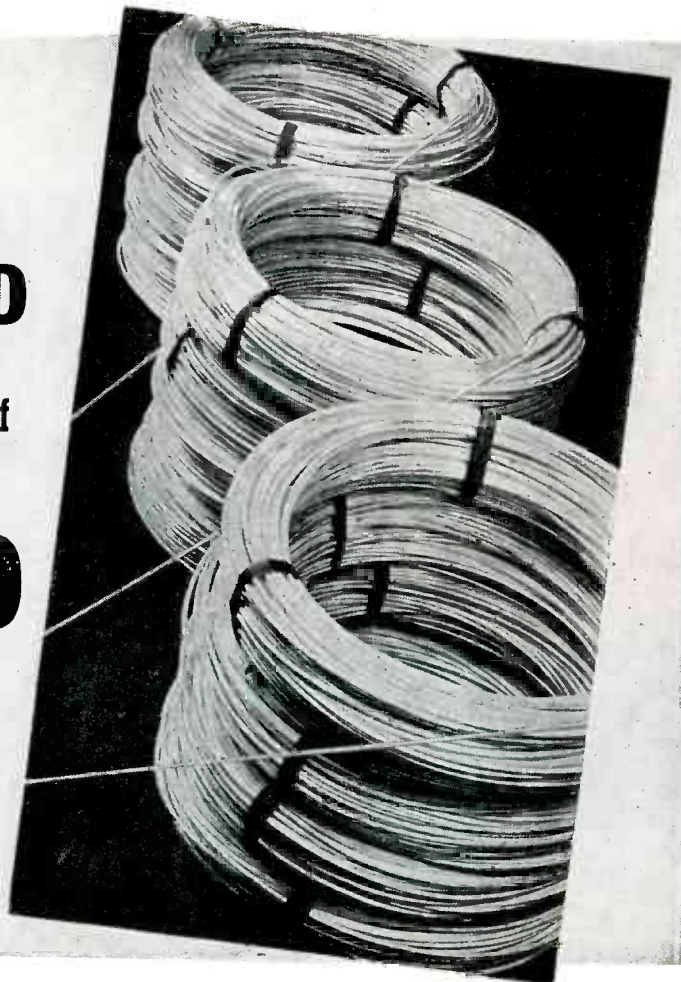

WILCO wire, tubing and other products are used in various electronic applications for the Army and Navy. In response to the wartime demand for these various products, the H. A. Wilson Company has enlarged its plant, increased its manufacturing facilities, added essential new equipment and developed new products and techniques. Both present and future customers will find these new WILCO developments of great advantage.

The H. A. Wilson Company manufactures and is interested in receiving inquiries regarding the following typical products—

#### WILCO JACKETED WIRE

Silver (Fine, Sterling or Coin)  
 Silver Jacketed Copper  
 Silver Jacketed Invar  
 Silver Jacketed Brass  
 Silver Jacketed Steel  
 Gold Jacketed Silver (Fine, Sterling, Coin)  
 Gold Jacketed Brass or Bronze  
 Copper Jacketed Monel  
 Nickel Jacketed Copper

#### WILCO JACKETED TUBING

Silver Tubing (Fine, Sterling or Coin)  
 Gold Tubing (any Color or Karat)  
 Silver Jacketed Brass or Bronze (one or both sides)  
 Gold Jacketed Silver (one or both sides)  
 Gold Jacketed Brass or Bronze (one or both sides)

#### WILCO STRIP MATERIAL

Silver (Fine, Sterling or Coin) on Brass or Bronze (Inlay or Overlay)  
 Gold on Silver (any Karat on Fine, Sterling or Coin)  
 Gold on Brass or Bronze

#### Other WILCO products include Electrical Contacts—

Silver, Platinum, Tungsten, Alloys, Powder Metal. *Thermostatic Bimetal* (High and Low Temperature with new high temperature deflection rates.) *Precious Metal Collector Rings*—For Rotating controls. *Silver Clad Steel*. *Rolled Gold Plate*. *Special Materials*.

*Let us analyze your problems.*

## THE H. A. WILSON COMPANY

105 Chestnut Street, Newark 5, N. J.

Branches: Detroit • Chicago







## DEPENDABLE

The real test of fine gears lies in their performance. Gears that operate smoothly, quietly, *dependably*, day after day, year in and year out . . . that's the type of product you can expect from us. For, here at "Small Gear Headquarters" you'll find all the intricate know-how . . . all the modern methods and machinery developed through a quarter century of intensive specialization. We've concentrated upon doing ONE job. Our customers say we do it superlatively well . . . designing and making gears ranging from 12 to 96 DP only. Should your post-war product call for uniformly excellent small gears that will give long, dependable service, we believe you'll benefit by discussing the problem with a G.S. engineer!



# GEAR Specialties

Spurs • Spirals • Helicals • Bevels • Internals • Worm Gearing • Racks • Thread Grinding  
2635 WEST MEDILL AVENUE • CHICAGO 47, ILLINOIS

WORLD'S LARGEST EXCLUSIVE MANUFACTURERS OF FRACTIONAL HORSEPOWER GEARS

# DO YOU NEED A CRYSTAL BALL?



**T**HERE are times in the lives of all good engineers when a crystal ball would come in mighty handy. We know because we've had many a problem where it looked like aid from the occult was the only solution. Instead, we found that sound engineering plus the outstanding physical properties of Corning's electrical glasses usually supplied the answers.

These same glass qualities are ready to help you produce better postwar electronic products. Which do you need?

1. High dielectric strength—high resistivity—low power factor—wide range of dielectric constants—low losses at all frequencies.

2. Permanent hermetic seals against gas, oil and water between glass and metal or glass and glass.

3. Commercial fabrication to the fine tolerances of precision metal working.

4. Corning's metallizing process produces metal areas of fixed and exact specification, permanently bonded to glass.

\* \* \*

Write us about your problems. We'd be interested in seeing if glass can help you. Address Electronic Sales Dept., E-8, Bulb and Tubing Division, Corning Glass Works, Corning, N. Y.

**CORNING**  
— means —  
Research in Glass

## Electronic Glassware



"PYREX", "VYCOR" and "CORNING" are registered trade-marks and indicate manufacture by Corning Glass Works, Corning, N. Y.

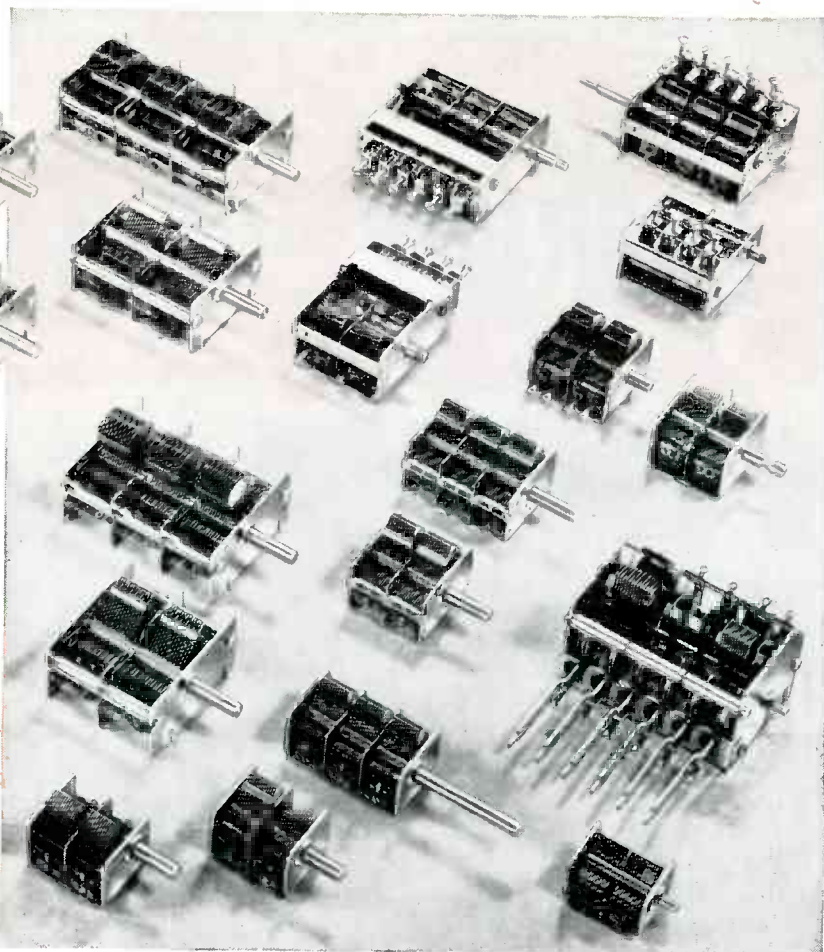

**THE MEN BEHIND**



**CAPACITORS**

**DURING** more than a quarter of a century, the Radio Condenser Company has acquired a staff of variable capacitor engineers second to none.

Under stress of war, these specialists have delivered the "know-how" as well as the product to our armed forces. Their record is an enviable one... their knowledge of variable capacitors is complete and up-to-date.

These are the men who will welcome the opportunity to help solve your post war variable capacitor and tuning device problems — and, as always, you can count on them for real results.



**RADIO CONDENSER CO.**

**CAMDEN, N. J.**

**RADIO CONDENSER COMPANY, LTD., TORONTO, CANADA**

*(Suppliers to Set Manufacturers)*

Announcing **THE NEW**  
**SUPREME MODEL 565**  
**VACUUM TUBE VOLTMETER!**

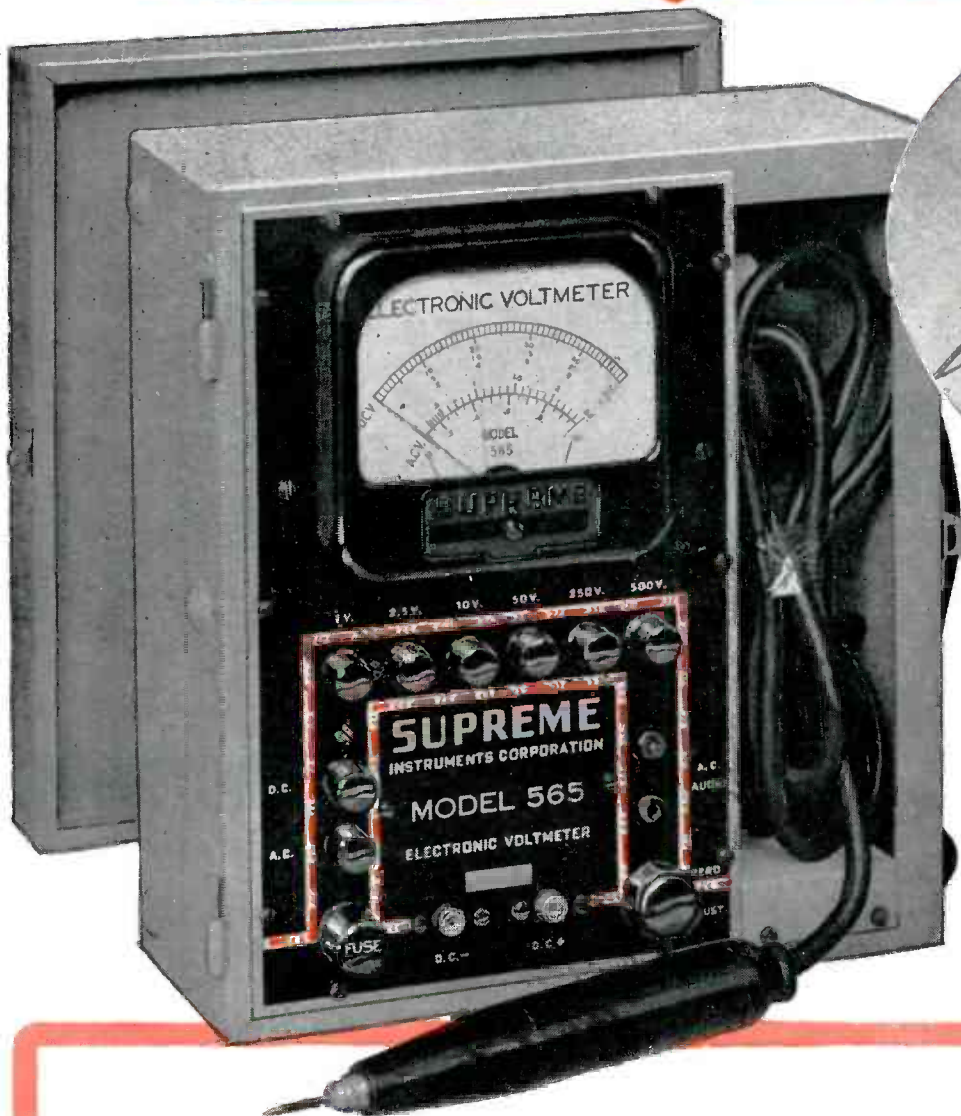

New type hand-fitting probe allows ease of measurements, handles just as any ordinary test lead. Probe incorporates new high-frequency diode giving best possible frequency response. Completely new, balanced, highly degenerative bridge circuit allows higher input impedances (less detuning on RF circuits) and greater stability than ever before.

**RANGES:**

DC 0-1, 2.5, 10, 50, 250, 500  
 AC 0-1, 2.5, 10, 50, 250

EXTENDED TO 5000 VOLTS BY EXTERNAL MULTIPLIERS

**INPUT RESISTANCE:**

DC—80 megohms on 1 volt range; 40 megohms on 500 volt range  
 AC—40 megohms on 1 volt range; 20 megohms on 250 volt range

**INPUT CAPACITY OF PROBE: 5 micro-micro farads**

**FREQUENCY RANGE:**

Negligible frequency error from  
 50 cycles to 100 megacycles.

**SUPREME INSTRUMENTS CORPORATION**

**GREENWOOD  
 MISSISSIPPI**



# RAYTHEON

## TYPE 6J6

### Miniature Dual Triode

For a considerable time Raytheon has been assigned a major role in supplying the essential requirements for a versatile, miniature, dual triode tube, type 6J6.

The precise manufacturing techniques which must be maintained are obvious when the physical structure of this tube is considered. Two high transconductance triodes are obtained from a single relatively large flat cathode, which also acts as a shield to prevent interaction between two separate half-grids. These are wound with extremely fine wire and are accurately spaced a few thousandths of an inch on either side of the cathode. Two individual half-plates complete the tube.

Applications utilizing Raytheon Type 6J6 are varied and numerous, ranging from a diode detector to an ultra high frequency push-pull oscillator capable of producing useful energy at frequencies of several hundred megacycles. Its unique construction lends itself to connection as a high permeance diode, a single very high transconductance triode, or a dual triode with a common cathode. The 6J6 is also used in cathode follower service and high frequency mixer applications.

Raytheon's continuing development work and long manufacturing experience means *better* tubes. Use Raytheon High-Fidelity Tubes in *your* postwar products!

#### SPECIFICATIONS OF 6J6

<b>DIMENSIONS:</b>		
Maximum Over-all Length	2 1/8	inches
Maximum Seated Height	1 7/8	inches
Maximum Diameter	3/4	inches
<b>RATINGS:</b>		
Heater Voltage	6.3	volts
Heater Current	0.45	amperes
Maximum Plate Voltage	300	volts
Maximum Plate Dissipation (per unit)	1.5	watts
<b>DIRECT INTERELECTRODE CAPACITANCES</b> (Approx. for each unit) — Unshielded:		
Grid to Plate	1.6	$\mu$ ft
Input	2.2	$\mu$ ft
Output	0.4	$\mu$ ft
<b>CLASS A<sub>1</sub> CHARACTERISTICS (Each Triode):</b>		
Plate Voltage	100	volts
Cathode Bias Resistor — Both units operating	50	ohms
Plate Current	8.5	ma
Transconductance	5300	$\mu$ mhos
Amplification Factor	38	
Plate Resistance (Approx.)	7100	ohms

*Listen to*  
"MEET YOUR NAVY"  
AMERICAN BROADCASTING CO.  
Every Monday Night  
Coast to Coast  
181 Stations

  
All Four Divisions Have  
Been Awarded Army-Navy  
"E" with Stars

# RAYTHEON

MANUFACTURING COMPANY  
RADIO RECEIVING TUBE DIVISION

NEWTON, MASSACHUSETTS — LOS ANGELES  
NEW YORK — CHICAGO — ATLANTA

DEVOTED TO RESEARCH AND THE MANUFACTURE OF TUBES AND EQUIPMENT FOR THE NEW ERA OF ELECTRONICS

**MYKROY**  
PERFECTED MICA CERAMIC INSULATION

# DOESN'T CARBONIZE!



This high frequency insulation will not carbonize under arc, yet it possesses dielectric properties of the highest order. Made entirely of inorganic materials, Mykroy cannot char or turn to carbon even when exposed to continuous arcs and flashovers.

The sheet of Mykroy in the photo was exposed to a 50,000 volt arc after which it was sectioned and carefully examined for signs of damage. None were found . . . not even the slightest excoriations were present, hence no low resistance paths formed to support breakdown.

Engineers everywhere are turning more and more to Mykroy because the electrical characteristics of this perfected glass-bonded ceramic are of the highest order—and do not shift under any conditions short of actual destruction of the material itself. Furthermore Mykroy will not warp—holds its form permanently—molds to critical dimensions and is impervious to gas, oil and water. For more efficient insulation investigate Mykroy. Write for copies of the latest Mykroy Bulletins.

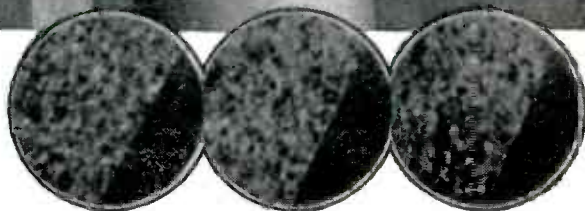

Cross sections of the test sheet made at the point of exposure to the 50,000 volt arc (magnified 10 times) show no trace of damage.

#### MECHANICAL PROPERTIES\*

MODULUS OF RUPTURE.....18000-21000psi  
HARDNESS  
Mohs Scale 3-4 BHN. BHN 500 K9 Load. 6-74  
IMPACT STRENGTH.....ASTM Charpy .34-.41 ft. lbs.  
COMPRESSION STRENGTH.....42000 psi  
SPECIFIC GRAVITY.....2.75-3.8  
THERMAL EXPANSION......000006 per Degree Fahr.  
APPEARANCE.....Brownish Grey to Light Tan

#### ELECTRICAL PROPERTIES\*

DIELECTRIC CONSTANT.....3.5-7  
DIELECTRIC STRENGTH (1/8").....630 Volts per Mil  
POWER FACTOR......001-.002 (Meets AWS -4)

#### \*THESE VALUES COVER THE VARIOUS GRADES OF MYKROY

GRADE 8 Best for low loss requirements.  
GRADE 38. Best for low loss combined with high mechanical strength.  
GRADE 51. Best for molding applications.  
Special formulas compounded for special requirements.

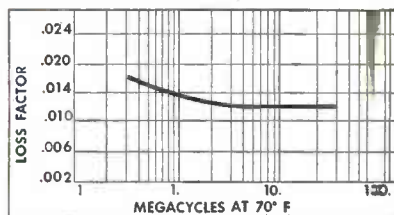

Based on Power Factor Measurements made by Boonton Radio Corp. on standard Mykroy stock.

MADE EXCLUSIVELY BY

**ELECTRONIC MECHANICS**  
INC.

70 CLIFTON BLVD., CLIFTON, N. J.  
CHICAGO 47; 1917 N. Springfield Ave., Tel. Albany 4310  
EXPORT OFFICE: 89 Broad Street, New York 4, New York

MYKROY IS SUPPLIED IN SHEETS AND RODS — MACHINED OR MOLDED TO SPECIFICATIONS



# WHAT ARE THE ACTUAL PRESSURES ON A PLANE IN FLIGHT?

NOW IT IS POSSIBLE to measure and record the pressures on any part of a plane at any time under any and all flight conditions in a wind tunnel or in flight. No longer need we rely on estimates or computations.

Waugh Laboratories offers pressure gages that may be affixed, as many as desired, to any part of a plane to provide a simultaneous record of pressures encountered.

Write for details of pressure gages *PRS-1* and *PS-4*.

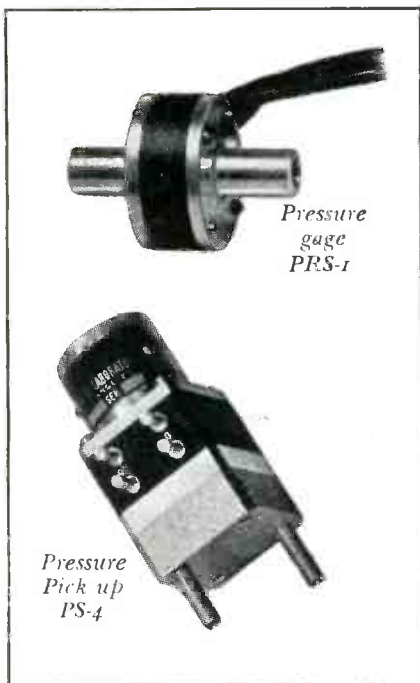

Pressure  
gage  
*PRS-1*

Pressure  
Pick up  
*PS-4*



Write for Rental  
List and Service  
Manual on busi-  
ness letterhead.

**WAUGH**  
*Laboratories*

Pacific Coast Branch: 180 East California St., Pasadena 5, California

◆ 420 LEXINGTON AVE., NEW YORK 17, N. Y.

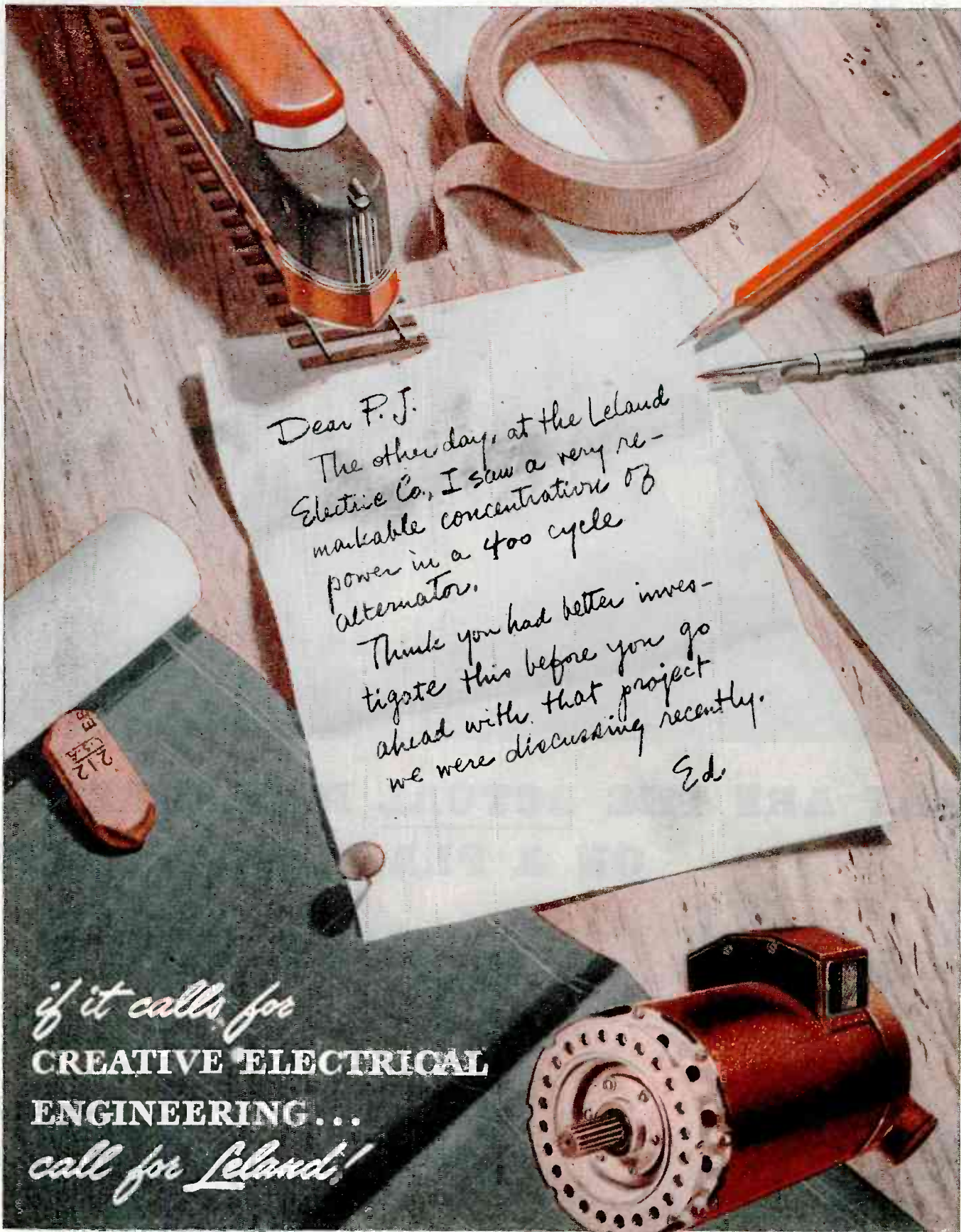

Dear P. J.

The other day, at the Leland Electric Co., I saw a very remarkable concentration of power in a 400 cycle alternator.

Think you had better investigate this before you go ahead with that project we were discussing recently.

Ed.

*if it calls for*  
**CREATIVE ELECTRICAL  
ENGINEERING...**  
*call for Leland!*



Motors, Generators, Motor Generators and Voltage Regulators

 **THE Leland ELECTRIC COMPANY**

DAYTON, OHIO • IN CANADA, LELAND ELECTRIC CANADA, LTD. ... GUELPH, ONTARIO





**FOR A JOB**

*Well Done...*

**T**HIS button, soon to be worn by thirteen million men and women—honorably discharged members of the Armed Forces of the United States—is a symbol of honor, an insignia of respect.

Wherever it is worn, it eloquently proclaims a victorious fight for Country and principles. It is indeed the chevron of service—the reward for a job done well.



**Jensen**

**SPEAKERS WITH ALNICO 5**

*Specialists in Design and Manufacture of Acoustic Equipment*

**JENSEN RADIO MANUFACTURING COMPANY • 6001 SOUTH LARAMIE AVENUE, CHICAGO 38, ILLINOIS**

**you can't *put the squeeze***  
**on SEALDTITE**  
**CAPACITORS**



Just try it . . . Take a genuine "Sealdtite" capacitor and try to *squeeze* it. No results. You'll find it has no soft spots, which in ordinary tubulars provide room for moisture, the capacitor's worst enemy, because the Solar capacitor has an internal winding of high quality paper and foil, skillfully *molded* into *solid* plastic.

No moisture can penetrate this protective case and its substantial construction permits rough handling, assures long and *reliable* service. Use "Sealdtite" capacitors. Send for your copy of Catalog V-4. Any Climate—Any Atmosphere—Any Service.



BAYONNE PLANT  
WEST N.Y. PLANT

A TOTAL OF EIGHT ARMY-NAVY  
EXCELLENCE AWARDS

SOLAR CAPACITOR SALES CORP.  
285 MADISON AVENUE, NEW YORK CITY

57 7567

# FREIGHT RATES

## *and* INDUSTRY LOCATION

---

A SIGNIFICANT decision, announced by the Interstate Commerce Commission last May, will take preliminary effect on the 30th of August. It will eliminate some of the advantage in freight rates which Eastern shippers have enjoyed over shippers of the South and West.

The decision has been enthusiastically hailed as an Emancipation Proclamation for industrial development in the South and West. It has also been roundly condemned as a meddling control measure that ignores valid differences in haulage costs, and recklessly blots out one of the important factors in determining the location of American industry.

Cooler appraisals indicate that the net effect of the rate changes will be far less drastic than predicted by the more passionate advocates or adversaries. Nonetheless, it is important for the business world to be informed both upon the principle at issue, and upon the foreseeable consequences of the ICC ruling.

### What The Decision Calls For

The Commission's order, unless modified, or successfully contested in the courts, will require: (1) the eventual establishment of a single freight classification, or grouping of commodities for rate-making purposes, for application throughout the United States; (2) a single level of "class rates"—or rates established for groups of commodities and primarily applying to manufactured and semi-manufactured articles of high value—in the area east of the Rocky Mountains. This level is to be about 15 per cent higher than the present Eastern scale.

Because it will take some time, probably several years, to work out a uniform classification in place of the three major classifications now existing, a preliminary adjustment is provided.

Under this adjustment the existing classifications will remain in effect, but the rates on articles moving on *class rates* will be increased 10 per cent in Eastern or Official Territory—the area east of Lake Michigan and the Mississippi River and north of the Ohio River. On the other hand, the rates will be reduced 10 per cent on articles moving on class

rates in the South and West, and on those moving interterritorially.

### What The Problem Was

At the present time there are marked differences in the levels of the basic scales of class rates in the five major rate territories—Eastern or Official, Southern, Western Trunk-Line, Southwestern, and Mountain-Pacific. It is difficult to average the levels of rates, but if the level of the class-rate scale in Official Territory is taken as 100, the levels in the other territories may be roughly considered as follows: Southern, 139; Western Trunk-Line, 128, 146, 161, 184 in Zones I, II, III, and IV, respectively; Southwestern, 161; Mountain-Pacific, 166.

These are over-all comparisons. On many individual articles the differences in levels of rates are greater or less than indicated because of offsetting differences in regional classification schemes. In many cases, the use of exceptions to the classifications and of special commodity rates has reduced the regional disparity in rates. In fact, on some articles, particularly on certain low-grade traffic such as logs, pulpwood, bricks, coal, sand and gravel, the South and the West have actually had lower rates than Official Territory. The rate disadvantage of the South and West has been principally on manufactured articles.

The territorial differences in class-rate levels have complicated the problem of constructing rates from a point in one territory to a point in another. Today, such a rate tends to represent a blend of the levels in effect at the place of shipment and at the destination. Thus manufacturers and dealers in a higher-rated territory are likely to see themselves at a disadvantage when they attempt to sell goods in a lower-rated territory against competition located there.

Now, if differences between territorial rate levels are removed, the *interterritorial* freight-rate problem largely disappears. So it is an important question whether such differences are justified. The Commission has found that they are *not* justified either by differences in transportation costs or by

other valid considerations. From that finding came the order to establish a uniform level of class rates and a single freight classification.

### The Decision And The Map Of Industry

What effect will this decision have on the location of industry in the United States; and what effect will it have on the economic development of the East, the South, and the West?

Today, many in the West and South believe that their higher class rates have seriously retarded the industrial development of these areas, and promoted the concentration of manufacturing in Official Territory. They point out that Official Territory has over 50 per cent of the population of the country, had nearly 70 per cent of the persons employed in manufacturing in 1940, and accounted for nearly 73 per cent of the "value added by manufacture" in 1939. Boasts of industrial development in the South, and to some extent in the West, in recent years are accompanied by claims that this would have been greater but for the freight rate structure.

Another point gets into the argument. Official Territory is not only the country's most highly industrialized section, but also its greatest consuming territory. It is the market which nearly all manufacturers desire to reach, particularly when they have a surplus to sell. Here again is occasion for an outcry by producers outside of Official Territory against the consequences of their high rate levels and the levels of interterritorial rates. Under the circumstances it is not strange that the South and West have argued long and volubly for mile-for-mile equality in rates.

Those in Official Territory deny that the South and West have been handicapped by the rate adjustment, but at the same time look with apprehension at the loss of their rate advantage.

### What's The Effect?

However, now that the ICC's ruling is about to be put in operation, it is time for the colorful statements of the debating period to give way to a sober appraisal of what the consequences are likely to be.

In the first place, it should be noted that the preliminary adjustment will affect only a small fraction of the traffic. Estimates indicate that only about 4 per cent of the full-carload traffic moves on regular class rates. About 11 per cent moves on exception ratings which are not affected by the preliminary order; and about 85 per cent moves on commodity rates, which were not within the scope of the Commission's decision. The proportion of less-than-carload lot traffic affected is much greater, since a large

part of it moves on class rates; however, less-than-carload traffic constitutes less than 1½ per cent of the total tons carried.

The permanent rate structure will probably affect more traffic than the preliminary order since, in the establishment of a uniform classification containing more classes than at present provided, many articles now moving on exception ratings are likely to be brought within the scope of the classification, and the same may be true of some articles moving on commodity rates.

But, even if a large proportion of the traffic were affected by the Commission's order, or if the principle of equality in rate levels is eventually extended to much of the traffic moving on commodity rates, these freight-rate adjustments cannot be expected to revolutionize the pattern of industrial location in the United States.

It seems evident that most industries now found in Official Territory are located there for other advantages than that of a lower level of freight rates, undeniable as such an advantage is. Insofar as that is the case, they have little to fear from equalization of the rate levels. For those which have, indeed, been dependent upon preferential rates and otherwise badly located, the removal of the preference and their consequent shift to some area possessing a real locational advantage would be desirable from the point of view of the national economy.

While the high degree of industrial concentration in Official Territory does not rest on such a flimsy basis as a lower level of class rates, the Commission's decision does remove one existing handicap to the growth and development of the South and West. The new adjustment should permit all sections of the country to develop the industries for which they have natural advantages. It should contribute to a sounder regional specialization than we have heretofore had.

This decision will neither destroy the economy of the industrial East, nor will it, overnight, assure the industrial flowering of the South and West. It constitutes one sound step toward establishing that equality of opportunity for all sections of the country which is essential to a nation that bears the proud title of *The United States*.

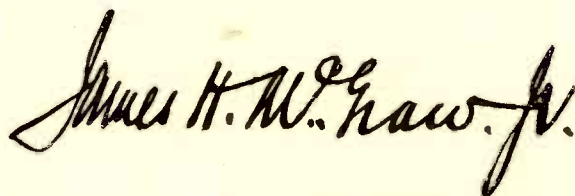

President, McGraw-Hill Publishing Co., Inc.

# 3 OUTSTANDING FEATURES OF THE NEW EIMAC 4-125A TETRODE

## 1 LOW DRIVING POWER

With but 2.5 watts driving power, the 4-125A will deliver 375 watts output at frequencies as high as 120 Mc. The low driving power requirement has been achieved without the use of excessive secondary emission. The control grid is specially processed to reduce both primary and secondary emission.

## 2 HIGH FREQUENCY PERFORMANCE

The Eimac 4-125A will deliver 200 watts output at 250 Mc. The performance curves below show the relationship between driving power and power output at frequencies up to 250 Mc.

FOLLOW THE LEADERS TO



EITEL-McCULLOUGH, Inc., 1085 San Mateo Avenue, San Bruno, Calif.  
Plants located at: San Bruno, California and Salt Lake City, Utah  
Export Agents: Frazar & Hansen, 301 Clay St., San Francisco 11, Calif., U. S. A.

## 3 LOW GRID-PLATE CAPACITANCE

The grid-plate capacitance of the 4-125A is only 0.03 uufd. This low value allows operation up to 100 Mc. without neutralization. Stability is further assured by the special grid processing which reduces secondary emission.

A technical bulletin on Eimac 4-125A Power Tetrode contains full specifications and detailed discussion of the tube's characteristics, circuit diagrams and constant current curves. Write for your copy today.

*The Eimac 4-125A is the first of many new Eimac tubes that are on the way. Watch for future announcements.*

### ELECTRICAL CHARACTERISTICS

Filament: Thoriated Tungsten	
Voltage	5.0 volts
Current	6.2 amperes
Plate Dissipation (Maximum)	125 watts
Direct Interelectrode Capacitances (Average)	
Grid-Plate (Without shielding, base grounded)	0.03 uufd.
Input	10.3 uufd.
Output	3.0 uufd.
Transconductance ( $i_b = 50 \text{ ma.}$ , $E_b = 2500 \text{ v.}$ , $E_{c2} = 400 \text{ v.}$ )	
	2450 umhos

1085

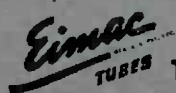
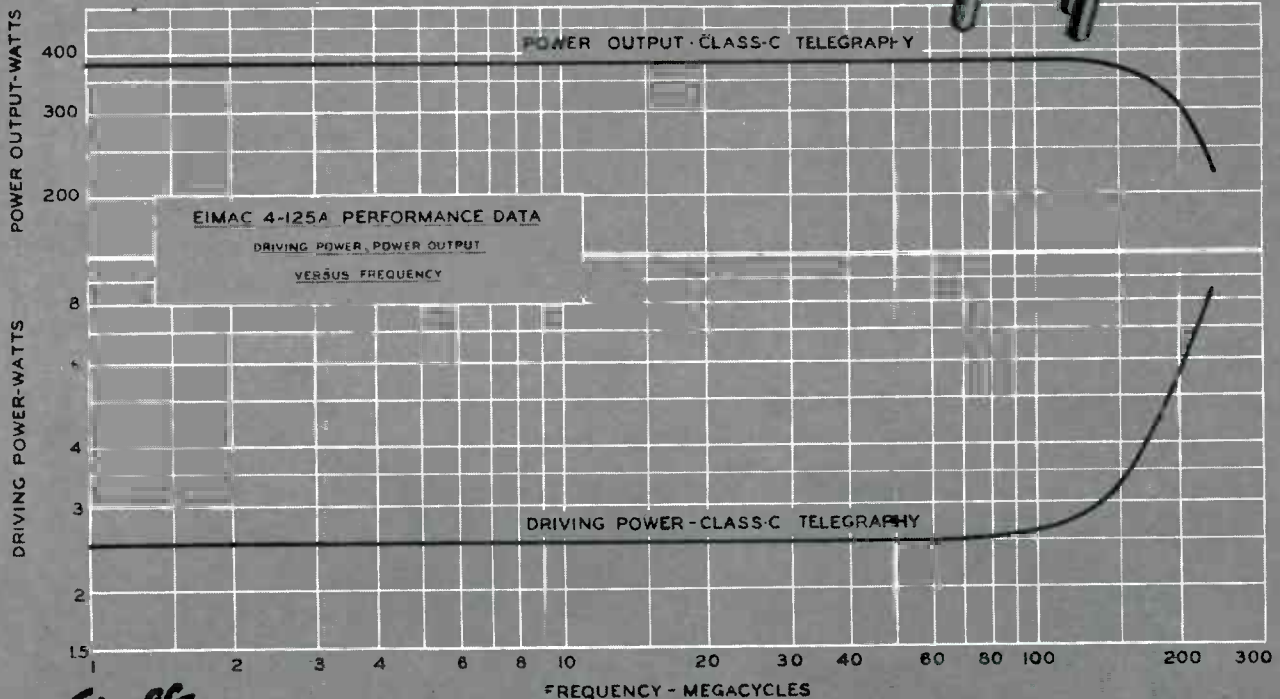

THE COUNTERSIGN OF DEPENDABILITY IN ANY ELECTRONIC EQUIPMENT

Dental operating unit with two Mallory Circuit Selector Switches on the front panel as current regulators, and a third Mallory switch at upper right to control the spray bottle warmer.



## More Comfort in Dental Equipment

Thanks to

P. R. MALLORY & CO. Inc.  
**MALLORY**

## Precision Switches

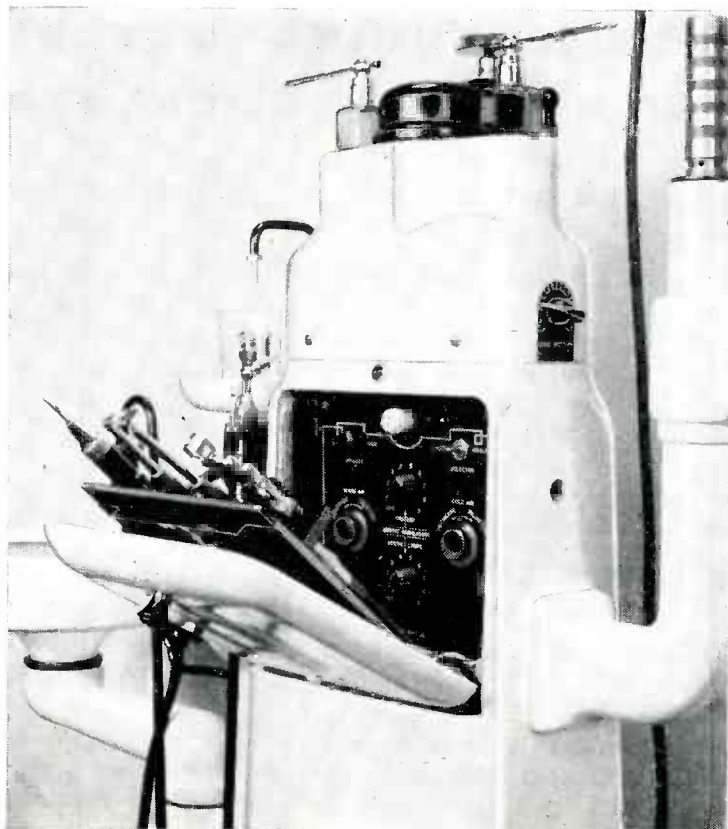

**E**FFICIENT operation of this modern dental unit, built by The Weber Dental Manufacturing Co., Canton, Ohio, is assured by its electronic controls—including three Mallory Circuit Selector Switches, two for regulating current, the third for operating the spray bottle warmer.

While these Mallory switches are *standard* parts . . . available throughout the country from Mallory Distributors . . . they are built to precision tolerances and incorporate such *special* features as: low-resistance, self-cleaning contacts; "hill-and-valley" index for smooth, positive switching action; heavy

insulating sections; notched shafts for easy cutting to desired lengths.

Electronic engineers designing industrial and professional equipment find it a great convenience to specify Mallory Approved Precision Products—multi-gang, single gang and push button switches, resistors, volume controls, jacks and plugs. You can simplify your own procedures . . . from blueprint through assembly line . . . by writing Mallory parts into your circuit diagrams.

Ask your Mallory Distributor for a free copy of the latest Mallory catalog. For engineering help on any specific problem, consult us.

P. R. MALLORY & CO., Inc.  
INDIANAPOLIS 6, INDIANA





P. R. MALLORY & CO. Inc.  
**MALLORY**

# Industrial and Electronic Switches



# CROSS TALK

► **RADAR** . . . Partial lifting of the blackout regarding radar—probably the war's greatest development—reveals that the fundamental principles and much of the detail are what any well-equipped engineer would dope out for himself. Two natural phenomena underlie all radar apparatus (1) Radio waves travel at a finite velocity of approximately 1000 feet per microsecond, (2) Radio waves striking a conductor or semiconductor cause currents to flow in that conductor and these currents cause a re-radiation of energy some of which, in the form of an echo, returns to the radar site. Add to these phenomena the ability of engineers to direct radio energy in sharp beams, their penchant for producing enormous degrees of voltage amplification, and elegant methods of measuring time to fractions of a microsecond, and you have radar.

In practice, high-powered (hundreds and even thousands of kilowatts) pulses of energy are sprayed over chosen sectors of space surrounding the radar transmitter. At the time the pulse is sent out, a stream of electrons starts to move across, or around, or in some other direction over the screen of a cathode-ray tube. When the echo returns, a deflection of this beam of electrons indicates the time of arrival by the spacial displacement of a pip from the start of the impulse.

Long range, early warning, radars must perforce operate on fairly long waves, 100 megacycles or so, and the radiating structures are correspondingly large to secure highly directive beams. Short range sets can operate on the microwaves (thousands of megacycles) and the antennas can be very small and still quite directional. The entire equipment can be compact and yet sufficiently powerful during the pulse time so that even mobile units can perform magnificently in active service.

Radar may be compared to older acoustic methods of plane detection in the following manner. The time of transit, out to the target and back, is some fraction or multiple of 500 feet per microsecond, approximately. On the other hand, sound waves travel in air at the rate of 1100 feet per second. Radar will detect a

plane as far off as 100 miles. Acoustic methods are doing pretty well if they detect a plane at, say, 25 miles. At 1100 feet per second, the sound from the plane will arrive at the detector site in about 2 minutes. The detector, therefore, tells the operator not where the plane is but where it has been. In the time required for the sound of the plane to reach the detector, a 360-mph plane will have cut in half its distance when it was detected.

Acoustic methods are virtually outmoded by the increased speed with which planes travel.

The radar principles—accurate measurement of time, pulse transmission, high directivity—may be used for purposes other than the location of targets in the air or on the surface of the land or sea. But these other uses remain behind the veil of military secrecy. Some of the applications are exceedingly interesting and effective in weapons of war and will go a long way toward justifying the belief that the peacetime age to come will really be electronic.

► **TUBES** . . . To an extent few of us realize, this scientific war we are waging depends upon vacuum tubes. One of the remarkable aspects of this fact is that millions and millions of tubes are serving under conditions for which they were not designed or manufactured. These millions of tubes are ordinary receiving tubes selling for a dollar or less in the home market. Designed for sedentary jobs, they now serve in tanks, on man's back, in submarines, on warships, in planes and in other places where the rigors of shock, vibration, temperature or electrical overload must cause the tubes to wonder how they ever got into such situations.

For years industrial engineers were skeptical about electronic apparatus because the tubes were too fragile. Wartime experience indicates that tubes do stand up when the apparatus in which they work is properly shock-mounted. In industrial plants, a routine of testing and replacing tubes on regular schedule—before trouble occurs—should eliminate all difficulties from fragility.

# SURPLUS EQUIPMENT

The government has set up machinery by which military radio and other electronic equipment may be marketed through regular trade channels by manufacturers. Details of the plan are given here, together with the latest news relative to its operation

**S**URPLUS radio and electronic equipment is already moving into the market in sufficient quantities to indicate the policy that the government intends to pursue in such disposals.

Under the provisions of the Surplus Property Act of 1944, the Reconstruction Finance Corporation is responsible for the disposal of capital and producer goods, which will take in the bulk of electronic surpluses.\* This agency, with one of its subsidiary corporations, the Defense Supplies Corporation, intends to work closely with manufacturers rather than to conduct sales on an "as is, where is" basis. It believes that the unloading of surplus should be a jointly sponsored and jointly conducted program in order

\*Department of Commerce handles surplus consumer goods, which includes home radio receivers.

By **G. T. MONTGOMERY**

*Washington Editor*

to give maximum advantages to both government and industry.

Every effort will be made to stabilize the price structure, which means no dumping of surpluses on the market and no harmful bargains. Surplus must move through legitimate channels at legitimate market prices. When the equipment has little or no market value, RFC plans to pursue a bold policy of scrapping it. Unless there is some definite use in mind, material will not be stored with the hope that someday a use will be found for it. For example, such will be the case with certain parts of Signal Corps high-frequency electronic equipment.

Reports of surplus radio and electronic equipment and components

are received by RFC from two main sources:

(1) Depots and warehouses of Owing Agencies, i.e., Army, Navy, Maritime Commission, OSRD, etc.

(2) Plants of contractors whose contracts have been terminated, in which event the Owing Agencies have taken title to unused material purchased for the terminated contract.

## Surplus Equipment Sources

In the case of surplus located in depots and warehouses, a formal report of surplus is made to RFC. On the basis of this report, orders are given to the Owing Agency to ship the material declared surplus to an RFC manufacturer-agent. Simultaneously, the manufacturer-agent is notified that the shipment is on its way.

In the case of material which is excess to the needs of a contractor whose contract has been terminated, RFC is notified of the surplus inventory as soon as the inventory has been compiled. Instructions are then given to the Termination Officer to have the material shipped directly from the contractor's plant to an RFC manufacturer-agent. The formal declaration of surplus is made upon the basis of the quantities actually shipped.

A short cut has been effected in the procedure for shipment of termination inventories by having them shipped prior to formal declaration of surplus, thereby expediting clearance of the contractor's plant. As an example, while this reporter was sitting in the office of an RFC official, an Army Termination Officer phoned that in a certain plant a large contract



Display of surplus parts and complete units at a central redistribution point



# DISPOSAL PLAN



Military electronic equipment is modified in a Defense Supplies Corporation plant to meet commercial needs

termination had occurred and the Army had acquired title to large quantities of resistors, capacitors, tubes, etc. Parts valued at \$100,000 were ready for packing and shipping to manufacturer-agents and manpower was available for the packing. In order to save time, permission was given by the RFC official to ship this portion of the stock from the contractor's plant to parts manufacturers for immediate re-sale, subject to clearance of necessary documents later. Since then the full termination inventory, composed of a listing of 68 pages of surplus parts, has been received by RFC.

## Conditions Governing Sale

Regardless of the source of the surplus material, the RFC manufacturer-agent receives a copy of the shipping order, which serves as his notice of the pending arrival of the material. When material actually arrives, he takes it into the

inventory which he is holding as agent of the RFC. He acknowledges receipt of the material by signing a copy of the original shipping order. He then inspects and tests the material to determine whether it is suitable for

- (a) Filling military orders
- (b) Filling civilian orders
- (c) Repair or modification
- (d) Scrap

After this classification has been made, he lists it for sale, provided it falls in Classes (a) or (b). If it falls in Classes (c) or (d), he is requested to submit to RFC his recommendation as to whether the material should be reworked, setting out his estimate of the cost of reworking and the price at which it can be sold after reworking. If he thinks the material should be scrapped, he is required to so state to RFC in order to receive formal approval for physical scrapping.

Material of a standard nature, i.e., comparable to that which the manufacturer normally sells, can be sold as a part of his regular stock. In fact, under the Agency Agreement, the manufacturer agrees that when filling orders he will include a certain percentage of the surplus stock which RFC is asking him to liquidate. Thus, the manufacturer is acting as an agent of the government on a commission basis.

In the case of a military order, the manufacturer must fill the order first from surplus stock, if possible. For instance, if the Signal Corps ships tubes to a tube manufacturer and the manufacturer at some later date gets an order from the Navy for these same tubes, the manufacturer must use the surplus tubes as far as they will go before he starts to fill the order from his own production. To give a concrete example, one manufacturer-agent had \$96,000 worth of capaci-

tors shipped to him as surplus. Shortly thereafter, he received a military order for \$20,000 worth of the same capacitors. The order had to be filled from the surplus stock.

#### Guarantees and Prices

Under the Agency Agreement, the manufacturer is permitted to sell surplus material with the same warranty that applies in his commercial sales. Hence a purchaser knows that when buying surplus electronic material he has the same assurance as in any other purchases which he regularly makes from that supplier.

If the material is non-standard, the manufacturer-agent may send out a special catalog and flyers to his customers, listing the material which he has to offer. Prices on nonstandard material may vary from regularly published price lists. It is necessary for the manufacturer to recommend prices which, from his knowledge of the market and potential uses, will represent a fair price to the government and to the customer. All such prices are subject to price approval by RFC.

The manufacturers receive the commission provided in the contract and any purchaser makes his normal margin of profit, with the chance of profiteering normally inherent in surplus dealing minimized.

Although minimum quantities of material which will be sent to manufacturer-agents have been established (based on the economy of handling), often relatively small quantities are shipped because it is felt that the manufacturer-agent will receive comparable items from other sources and by combining the various small quantities he may make a regular offering of the combined total. The undesirable alternative would be to offer odd lots at give-away prices.

#### Many Manufacturers Participating

Defense Supplies Corporation, acting for RFC, has signed over 200 manufacturers to act as agents for disposal of surplus. What happens to surplus in plants where the owners have not signed the Agency-Agreement?

Let us say that there are 25 manufacturers of a certain component. Ten manufacturers are interested in handling their own surplus, while 15 are not. An effort is made by DSC to get one of the ten to take over the other manufacturers' surplus, since he has the proper equipment for testing it. In case none of the ten want it, the surplus, if useable, is turned over to a central agent, who adds such items to his business. (To date, 15 companies have agreed to take end-equipment and component parts other than their own.)

Some manufacturers want to be rid of surplus so they can get ready for postwar competition as soon as possible. They fear that there will be an avalanche of a wide variety of items and they do not want it on their shelves. Others feel that their normal outlets for peacetime products do not lend themselves to the sale of specialized products. Still others are too busy with war work to enter into a program of this nature at this time, but plan to do so as soon as possible. Regardless of the reason, RFC is proceeding with its program to dispose of all surplus electronic items under the plan described, no matter who the manufacturers may have been.

The Reconstruction Finance Corporation believes that a substantial

percentage of the electronic equipment declared surplus, although originally designed for military purposes, can be sold by manufacturer-agents without modification. In all instances such equipment must be repaired and missing parts supplied. Examples of equipment of this nature are aircraft transmitters and receivers suitable for commercial operation, vehicular equipment of types desired for police or dispatching purposes, and small marine equipment. A relatively small quantity of such equipment has already been tested, repaired and sold.

#### Types of Gear Available

There will obviously also be large quantities of equipment and components which were designed for such specialized military applications that no commercial outlet is likely to be found for them in their present form. In these instances engineering surveys by manufacturer-agents will develop any modifications which can be economically made to adapt the units for civilian usage. An example is the redesign and modification of interphone equipment previously used in Army tanks. The present redesign involves the elimination of the microphone and the headset which are not at present available in surplus stocks and the substi-



Declassified Signal Corps high-frequency apparatus

tution of a speaker system for this purpose. Testing of the market has disclosed that the redesigned unit will sell at a price which exceeds the best "as is" sale price by substantially more than the cost of modification.

Another instance of desirable modification has arisen in connection with the declaration by the services that a very large quantity of two models of obsolete Signal Corps equipment are no longer required. Because of the bulk of the equipment and the tactical purposes for which it was designed, it was immediately apparent that it could have no useful civilian application. However, engineering surveys disclosed, especially in the case of one model, that many of the major sub-assemblies could be sold "as is" or with modification for industrial or scientific uses. The transmitter, which cannot be used for ordinary broadcasting, may be adaptable for use as an electronic heating set, according to officials. The electronic rectifier may be saleable as such. Parts may be useable, with changes, as test equipment. On the other hand, two receiver units would have to be extensively modified for conventional uses, if they are to be useable at all.

#### Rectifiers Come First

The first units to go on the market are electronic rectifiers, of which there are three kinds:

**High-Voltage Power Supply**—This power supply was designed to furnish plate voltage for one of the large Signal Corps mobile high-frequency sets. Manufactured according to Signal Corps specifications, it combines all of the usual features found in commercial equipment, plus additional safety factors in design necessary in equipment destined to operate under all types of field conditions. The output voltage obtainable from the unit is continuously variable from 0 to 15,000 ma when type 371-B rectifier tubes are employed. It is possible to substitute 872-A rectifier tubes in the unit without major circuit changes and obtain much higher output current at voltages up to 6,000 volts.

**Triple Power Supply**—This unit contains three power supplies employing a two-stage-amplifier volt-

age-regulator circuit which assures regulation and freedom from hum. Power supply No. 1 has a variable-voltage range from 750 to 900 volts dc at a maximum load of 125 ma. Line voltage may drop to as low as 85 v ac on medium loads and 100 v ac on maximum loads, throughout the voltage range from 750 v dc to 900 v dc. The ripple content within these voltage ranges is less than 5 millivolts from no load to full load.

Supplies number 2 and 3 are identical, having a variable voltage range from 230 v dc to 330 v dc at a maximum load of 400 ma. Line voltage may be as low as 80 volts at 200 ma and 100 volts at maximum load. Ripple content is less than 5 millivolts at all loads and voltages.

**Low-Current Power Supply**—This unit supplies voltages between 500 and 15,000 volts dc at 35 ma. Ripple voltage at full load is 6 percent.

#### Original Equipment Expensive

It is not possible at this time to estimate the number of units that will be available from obsolete high frequency equipment. There were about 2800 of one model manufactured and approximately 1000 of the other, at a cost of well over \$200,000,000 to the government. How many have been destroyed and how many are listed as surplus is not known. It has been estimated that the average cost of one complete model is about \$40,000. As a single unit this model would be a dead loss to the government.

There will be some surplus units which cannot economically be adapted to meet civilian needs. When this fact has been clearly established, normally after complete investigation by more than one manufacturer, the RFC will approve the salvage of components. For instance, there is one particular tube used in a set which represents a government investment of between four and five million dollars. Each tube, which originally cost about \$50, now is priced at \$19 and the only recoverable value seems to be about 30 cents for the platinum in it. So far, no verdict has been handed down regarding its disposal.

To date the following approxi-

mate numbers of tubes have been declared surplus by Owning Agencies at the dollar value indicated opposite each type:

Type	Quantity	Value
Receiving tubes	3,158,000	\$1,900,000
Transmitting tubes	2,862,700	11,700,000
Cathode-ray tubes	136,000	1,860,000
Photoelectric tubes	12,800	10,500
Special-purpose tubes	54,300	78,500
Other tubes	106,000	447,000

Of the above tubes declared surplus, practically 100 percent have been returned to DSC manufacturer-agents, save for approximately 510,000 transmitting type tubes, valued at \$5,560,000, and 13,000 cathode-ray tubes, valued at \$195,000.

#### Anti-Trust Law Clause

An important clause in the Surplus Property Act, which cannot be overlooked in any discussion of surplus disposal, has to do with avoiding any violation of the anti-trust laws. It states in Sec. 20:

"Whenever any disposal agency shall begin negotiation for the disposition to private interests of a plant or plants or other property which cost the Government \$1,000,000, or of patents, processes, techniques or inventions, irrespective of cost, the disposal agency shall promptly notify the Attorney General of the proposed disposition and the probable terms or conditions thereof. Within a reasonable time, in no event to exceed ninety days after receiving such notification, the Attorney General shall advise the Board and the disposal agency whether, in his opinion, the proposed disposition will violate the antitrust laws. . . . Nothing in this Act shall impair, amend, or modify the antitrust laws or limit and prevent their application to persons who buy or otherwise acquire property under the provisions of this Act."

The Department of Justice has gone over the RFC agreement forms and to date has found no violation of the antitrust laws.

The agency agreement contains a provision that the manufacturer may not, without the prior consent of RFC, sell more than 80 percent of any type of equipment or component shipped to him, nor may he purchase more than 50 percent of any type for use in his own production unless the prior consent of RFC is given. This safeguard was set up to assure the government that government-owned surplus would not be used by any manufacturer to place himself in a preferred position at the expense of other manufacturers or the industry as a whole. These restrictions do not apply in the event of sale of the equipment or components for use in war production.

# Motor Noise Unit

By **BYRON E. PHELPS**

*International Business Machines Corp.  
New York, N. Y.*

**T**HE 7-A-3 bombing trainer was developed by the Navy Bureau of Aeronautics, Special Devices Division, to give the student bombardier authentic bombing practice and experience without leaving the ground. The trainer reproduces every condition encountered in actual bombing procedure so accurately that the student needs little adjustment when he eventually goes aloft. It consists of a replica or mockup of the bomber compartment of a huge four-motored heavy bomber (PB4Y), known by the Army designation as the Consolidated B24.

All the instruments, including a late model bombsight, are included in the mockup. An ingenious projection device produces a moving image of the ground or target area in exact proportion to the speed and altitude of the plane. Refrigerating equipment is used to cool the compartment to make it necessary for the student to learn how to handle delicate instruments while encumbered with bulky flying clothing.

To complete the realism, it was

necessary to duplicate the motor noise and vibration which would be present in a real plane. Such a motor-noise unit must duplicate as nearly as possible the actual motor sounds as heard in the bombing compartment. It was also desired that the speed of the "motors" be controllable by the instructor, and

that at least two separate noise generators or motors be used so that the characteristic low-frequency beat of multiple motors not in exact synchronism could be obtained.

## Noise Analysis

The development of the motor-noise unit was based on a simple analysis of the noise produced by an airplane engine. It was assumed that most of the noise came from the exhaust and that the exhaust produced the fundamental noise frequency; also that the exhaust note varied from cylinder to cylinder due to variations in cylinder conditions and in length of exhaust piping and that this variation would occur rhythmically at a frequency several times lower than the fundamental, depending on the number of cylinders and the type of exhaust manifold; also, there would probably be other variations or added sounds caused by propellers, bearings, timing gears, etc.



FIG. 1—Interior of the bombardier's compartment in the PB4Y mockup. Two loudspeakers are mounted behind the cloth wall above the bombardier's head and two others are concealed in dummy ammunition boxes at each side

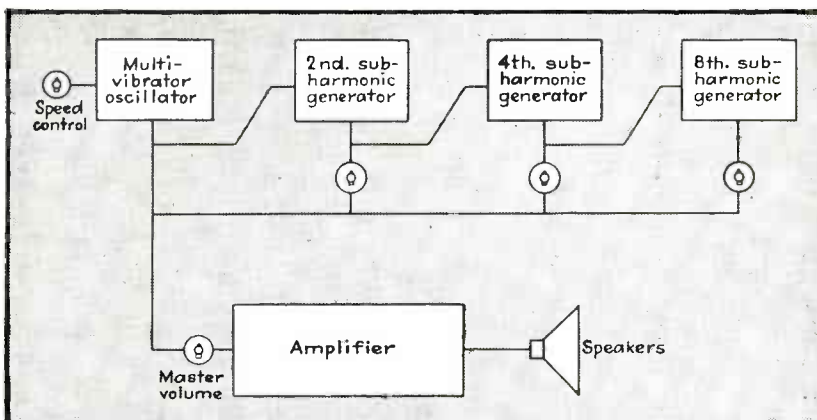

FIG. 2—Functions of the several stages of the noise generator are illustrated by this block diagram

# for Aircraft Trainer

To simulate the motor noise and vibration present in an airplane, electronic units are used in bombing trainers. A multivibrator produces the fundamental tone, three trigger circuits add subharmonic frequencies, and the resultant tone is amplified

These again would have basic frequencies several times lower than that of the exhaust fundamental.

Based on this analysis, a device to simulate motor noise should have a fundamental tone generator whose output would resemble the exhaust, plus several tone generators or tone modifiers which would operate at frequencies lower than the fundamental to simulate the variations in, or additions to, the exhaust note. Rather than attempt to analyze just what frequencies should be used for these modifying tone generators, the problem was approached from the angle of how realistic a sound could be obtained by using modifying frequencies most easily obtained.

## Multivibrator as Tone Source

For the fundamental exhaust note generator, a conventional twin-triode multivibrator oscillator was used. This type of oscillator was chosen for two reasons, first because the relatively square-wave output (with some modification) gave a very realistic sound output; and second, because the frequency of oscillation or speed could be varied over a wide range by means of a simple dual potentiometer.

To produce the modifying tones, a series of three trigger circuits were added as frequency dividers. These were connected in cascade and driven by the multivibrator so as to produce respectively a first, second, and third subharmonic frequency. (Since this was essentially a sound problem, the musical harmonic terminology was used. In the usual radio terms these would be the second, fourth and eighth subharmonics). When the subharmonics are properly blended with the output of the multivibrator and con-

verted to sound by suitable speakers, the result is a very realistic imitation of an airplane engine.

Each trainer uses two noise units, each of 30 watts peak power, and each driving two twelve-inch heavy-duty speakers. The sound is not only quite intense but also produces considerable vibration in the mock compartment, which adds much to the impression of being in a real plane.

Figure 1 shows the interior of the mockup of the PB4Y bombing compartment. Figure 2 shows a block diagram of the noise generator. Other photos show the production models of the noise unit chassis which contains two separate noise generators complete with separate amplifiers and separate power supplies.

## Signal Generation

The operation of the circuit shown in Fig. 3 is as follows:

The multivibrator oscillator is of the conventional twin-triode type employing a 6SN7 twin triode tube. The cathodes of the triode elements

are connected to the +90-volt line and the plates to the +240-volt line through 40,000 ohms total plate load each. The grids are each returned to the cathode, +90-volt line, through an adjustable resistance of 100,000 ohms maximum and a limiting resistor of 5,000 ohms. The 100,000-ohm adjustable resistors are the two halves of a dual potentiometer.

Each triode plate is coupled to the grid of the opposite triode plate through a 0.1- $\mu$ f capacitor. So connected, the twin triodes act like a see-saw, with first one tube conducting and then the other. To follow through the operation very briefly, assume that the triode section on the left starts to conduct. As it starts to conduct, its plate voltage will drop nearly to cathode potential. This sudden shift downward in potential is transmitted to the right-hand grid through the 0.1- $\mu$ f coupling capacitor, making the right hand triode non-conductive. The right-hand grid will immediately start to rise back to cathode potential as the charge

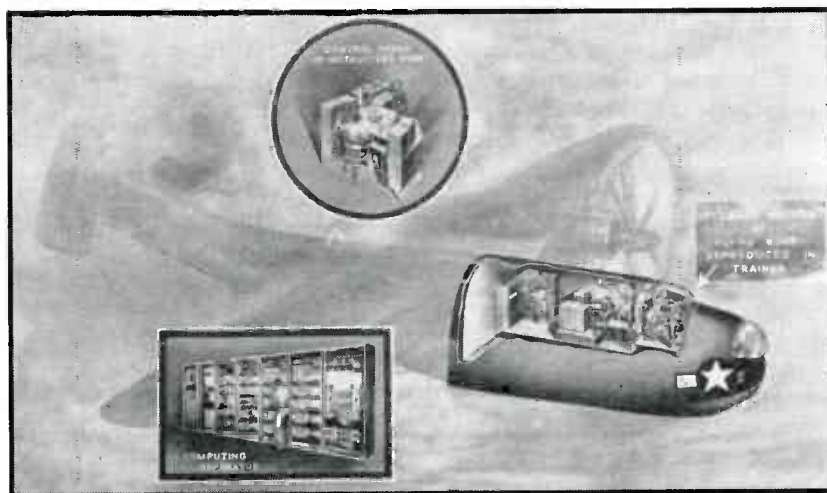

PB4Y flight crew trainer. It includes electronic equipment designed to simulate motor noise and similar to the gear discussed in the text

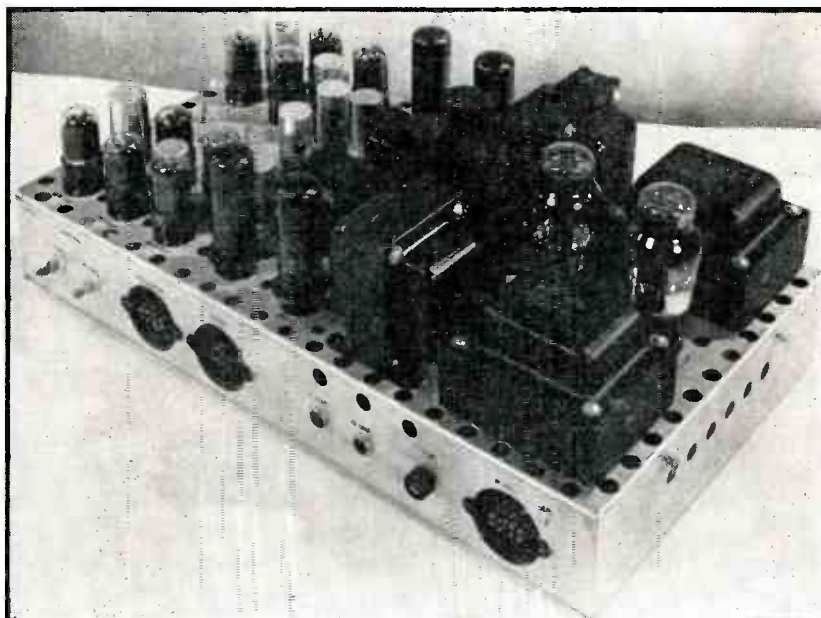

Two complete tone generators and amplifiers are mounted on one chassis. Separate power supplies are included for each

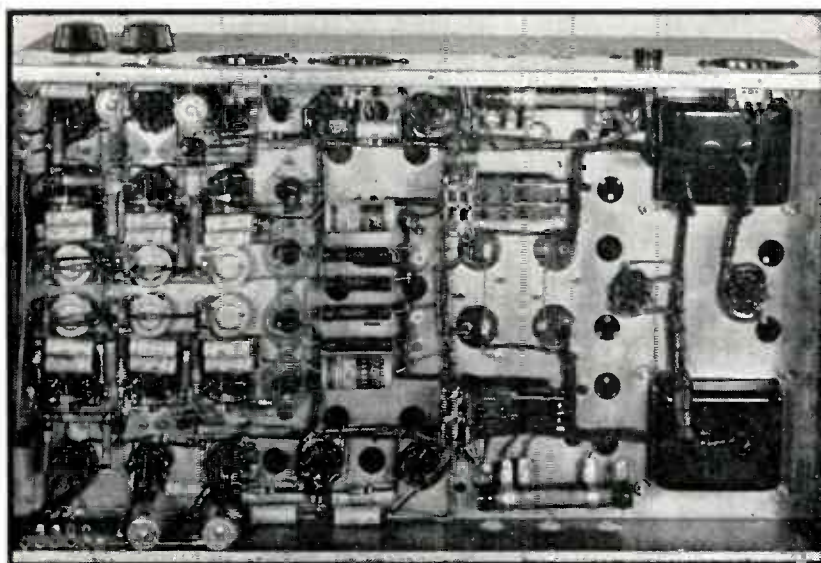

Under-chassis view of the electronic portion of the noise generator. Shielded leads permit the speed controls to be located on the instructor's desk

leaks off the coupling capacitor through the variable grid resistor. When a potential of 10 volts negative to cathode is reached, the right-hand triode will start to conduct and in a similar manner bias off the left-hand triode. When this newly created bias on the left-hand triode leaks off, it will again conduct and bias off the right-hand section.

The rate at which this transfer, see-saw, or oscillation occurs is determined by the discharge rate of the coupling capacitors through the grid-return resistors. By making the latter variable, it is possible to vary the frequency over a very wide range. In the circuit shown, the

change from minimum resistance of 5,000 ohms to a maximum of 105,000 ohms produces a speed change of from 300 down to 20 cycles per second. For signal output, one plate resistor is tapped at the midpoint and coupled to the common amplifier input through a 1-megohm decoupling resistor. A direct plate connection is used to furnish the signal for driving the first subharmonic generator.

#### Trigger Circuit as Frequency Splitter

The first subharmonic generator consists of a trigger circuit of the Eccles-Jordan type, but with the component values so chosen that it responds only to negative pulses

and can thus be used as a frequency divider without additional tubes. It consists of the two triode elements of a 6SN7 twin triode tube, with the plate of each triode coupled to the grid of the opposite triode in such a manner that if either triode is conducting it will hold the grid of the other triode well below cutoff. Thus either triode may conduct, but only one can conduct at a time.

A negative impulse applied simultaneously to both grids through the 0.00045- $\mu$ f coupling capacitors will momentarily bias off the conducting triode and the other triode will become the conducting one. A second negative pulse will cause the first triode to again conduct, etc. Thus two negative pulses will produce one complete alternation, see-saw, or oscillation.

Within reasonable limits, a positive pulse will not effect this trigger. When the 0.00045- $\mu$ f capacitors are coupled to the right-hand plate of the multivibrator, the trigger grids will receive one negative impulse for every cycle of the multivibrator and will make one complete alternation or cycle for every two cycles of the multivibrator. Thus whatever the multivibrator frequency, the 1st subharmonic generator will oscillate at one-half its frequency.

#### Mixing the Outputs

Likewise, the 2nd subharmonic generator, coupled to the output of the first subharmonic generator, will oscillate at one-half the frequency of the first subharmonic generator or one-quarter the frequency of the multivibrator. The third subharmonic generator will oscillate at one-eighth the multivibrator frequency.

The output of each subharmonic generator is controlled by a 0.5-megohm potentiometer and is coupled to the common amplifier input through a 1.0 megohm decoupling resistor. The best blending for normal use consists of all three potentiometers in approximate physical center although special effects can be produced by other proportions. For example, a pronounced knocking like that caused by a loose connecting rod can be produced at low speed by turning

the third subharmonic control full on.

### Power Amplifier Stages

The audio amplifier is of conventional design employing a 6J5 first audio amplifier, 6SN7 as second audio and phase inverter, and two 6L6's as power amplifiers. The only departure from standard design is in the coupling between the first and second amplifiers. A small 0.005- $\mu$ f coupling capacitor is used with a 0.01- $\mu$ f tone-control capacitor. This combination was selected from many possible combinations to provide the most realistic sound output as judged by experienced airmen. The sound output is designed to resemble that inside the bombardier's compartment rather than that heard from outside the plane.

Multivibrator oscillators as used in this device are very sensitive to voltage variations and tend to lock in with each other if any appreciable coupling exists. Any tendency to lock in would defeat the main purpose of the dual units, that is, to produce the characteristic low-frequency beat of multimotored

planes with motors not in exact synchronism. Therefore the units were isolated physically and electrically as completely as possible.

Separate power supplies were used for the same reason, plus the fact that it permitted the use of two standard receiver type power transformers rather than one special heavy duty transformer. It was necessary also to shield the leads to the speed-control potentiometers which were mounted on the instructor's desk at some distance from the chassis.

### Reproducer Problem

The loud speakers which produce the final sound output are mounted within the mock compartment and presented problems of their own. The frequencies to be reproduced were very low, normally ranging from 200 cycles for the fundamental oscillator frequency to 50 cycles for the third subharmonic, and lower if the speed was reduced. To make it worse, the mockup construction permitted very little baffle area. Almost no data was available to suit these conditions. Speaker manufacturers considered

the conditions almost impossible for suitable results.

After considerable experimentation and testing, the loudspeakers were arranged as follows: Two 12-inch, heavy-duty pm units with peak ratings of 30 watts each were used for each amplifier (four per dual unit). To provide low-frequency loading, the speakers were mounted in independent, totally enclosed baffles with a volume of approximately one cubic foot, the shape of the baffle box being determined by its location in the trainer. Without the loading by these enclosed baffles the speakers would soon tear themselves to pieces.

Two of the speakers are mounted, concealed behind the cloth lining, above and on each side of the bombardier's head, and two are mounted in the dummy ammunition boxes below and to the right and left of the bombardier. The speakers on one side are connected to one amplifier to further the sense of separate motors. While far from ideal, this speaker arrangement has given satisfactory sound output and excellent speaker life.

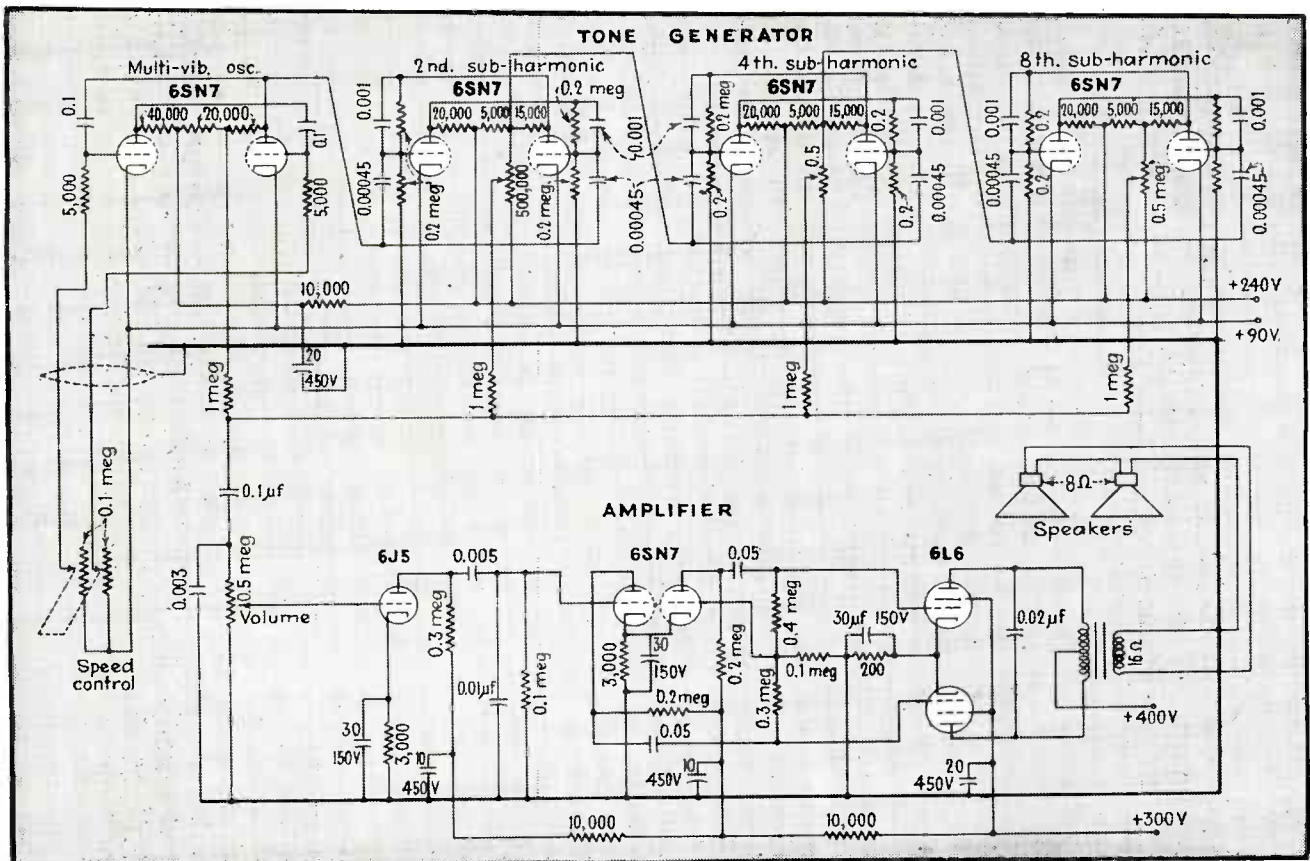
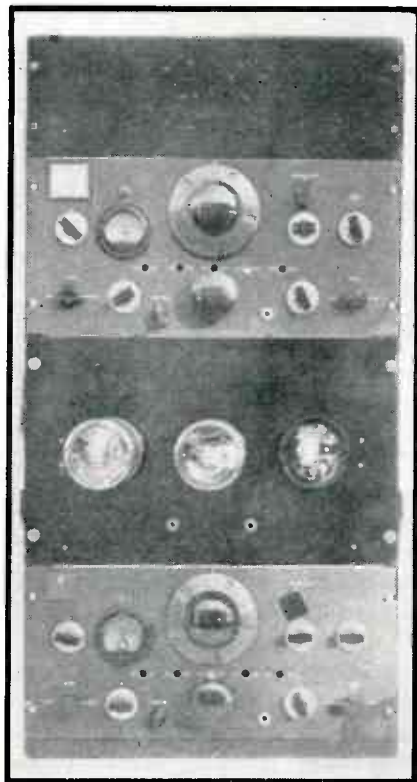

FIG. 3—Circuit diagram of the noise generating unit for simulating the engine exhaust sounds of a plane in flight

# Remote Tuning



Remote-controlled unit, containing C-W and C-W-phone receivers, and relays

Remotely-located radio receivers are tuned over a limited band by means of reactance tubes connected across their oscillator tank circuits. The reactance tubes are controlled by direct voltages applied over connecting telephone lines

By **H. B. BARD, Jr.**

*Radio Engineering Aide  
U. S. Immigration Service  
Los Angeles, Calif.*

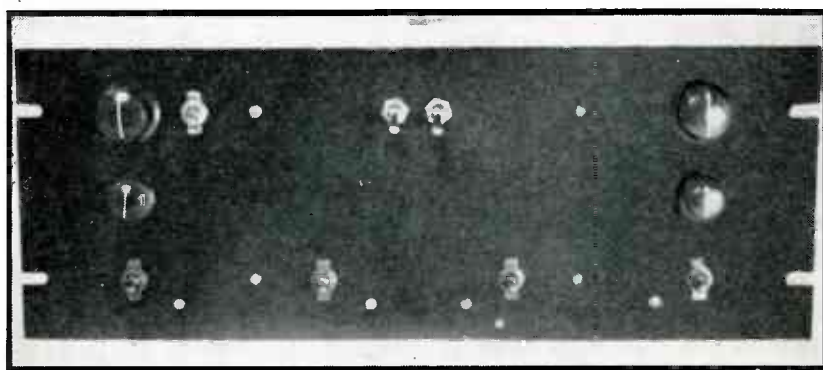

Office control unit, providing on-off control and tuning control of two remote receivers, and local volume control

**I**N MOST radio receiving stations involving remotely controlled equipment it is desirable to be able to exercise at least a limited amount of tuning from the control location. Transmitter frequencies will vary slightly within the permissible tolerance allowed. In order to compensate for such slight variations it is necessary to shift the receiver frequencies slightly to provide optimum reception.

Several means have been utilized in the past, such as motor-driven tuning capacitors, stepping relays which switch in various crystals or capacitors, and the transmission of i-f signals over telephone lines. Each of these systems has its merits but from the constructional standpoint they are complicated mechanically or electrically, or do not provide continuous variation of the controlled frequency.

## Basic Principle

An electronic, continuous, and simple means of control can be achieved by utilizing a reactance-tube circuit. Such a circuit is one in

which a direct-current or voltage variation is converted into a variation in impedance at the output terminals. The impedance variation may be either capacitive or inductive, depending upon the component parts used in the circuit, and is achieved by the use of a tube that draws from its load either a leading or lagging current with reference to the impressed voltage.

The use of reactance tubes is common in the automatic-frequency-control circuits of receivers and in the modulators used in some types of frequency-modulated radio transmitters.

Figure 1 shows a basic reactance tube circuit in which a change in d-c voltage on the control grid, through  $R_1$ , produces a reactance change between points  $A$  and  $B$ . Capacitor  $C_1$  is a blocking capacitor,  $C_2$  is a phase splitting capacitor, and  $C_3$ ,  $C_4$ , and  $C_5$  are bypass capacitors. Resistor  $R_2$  merely drops screen voltage to a desirable value.

Points  $A$  and  $B$  are attached to the circuit over which control is desired. In the example under dis-

cussion in this instance, a receiver oscillator is to be controlled and therefore  $AB$  is connected across the oscillator tank circuit. Inasmuch as the impedance presented at  $AB$  may have a resistive term, there will be some loading of the oscillator circuit by the control tube. The magnitude of the resistive term diminishes as the phase difference between the grid voltage and the impressed voltage at  $AB$  approaches ninety degrees.

## C-W vs. Voice Reception

When tuning a receiver by means of the reactance-tube circuit several different methods may be used. Where reception is limited to voice signals, it is necessary to control the high-frequency oscillator, but for the reception of C-W telegraph signals the control may be applied to the beat-frequency oscillator and the high-frequency oscillator may be crystal controlled.

The range of frequency variation at 5 mc when the high-frequency oscillator is controlled may be as high as 30 kc with a 12-volt bias



# With Reactance Tubes

variation. When the control is applied to the beat-frequency oscillator at 465 kc the available variation in beat note is approximately 10 kc each side of zero beat for a total bias variation of 12 volts. The amount of variation, or control, is largely determined by the amount that the grid bias on the reactance tube is varied and the value of the coupling capacitor  $C_3$ ; the larger this capacitor the greater the control.

## Circuit Variation

Figure 2 shows schematically a typical installation in which two receivers are remotely controlled over two telephone lines. Closing the dpst power switch at the office turns on the office amplifier and also turns on the remote receivers. Closing the tuning switch at the office

applies bias to the two remotely located reactance tubes. Variation of the tuning-control potentiometers changes the output reactance of the two reactance tubes and accomplishes the desired tuning. Audio output of the two receivers is fed back to the office over the associated telephone lines and applied to the

office amplifier input through potentiometers and spst switches providing individual control.

In this instance one remote receiver is used for c-w reception and the other for voice and therefore one reactance tube controls a beat-frequency oscillator while the other controls a high-frequency oscillator, as previously outlined. Where both c-w and voice are to be received with one receiver it is a simple matter to arrange remote switching of a reactance tube from beat-frequency oscillator to high-frequency oscillator or vice versa. In such instances additional relays are connected in series with the power relay and adjusted to pull up at different currents. An additional potentiometer included in the relay battery circuit permits suitable currents to be selected.

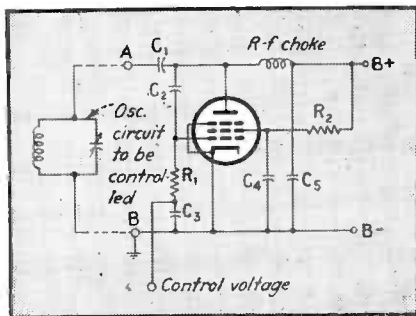

FIG. 1—Fundamental reactance-tube tuning circuit

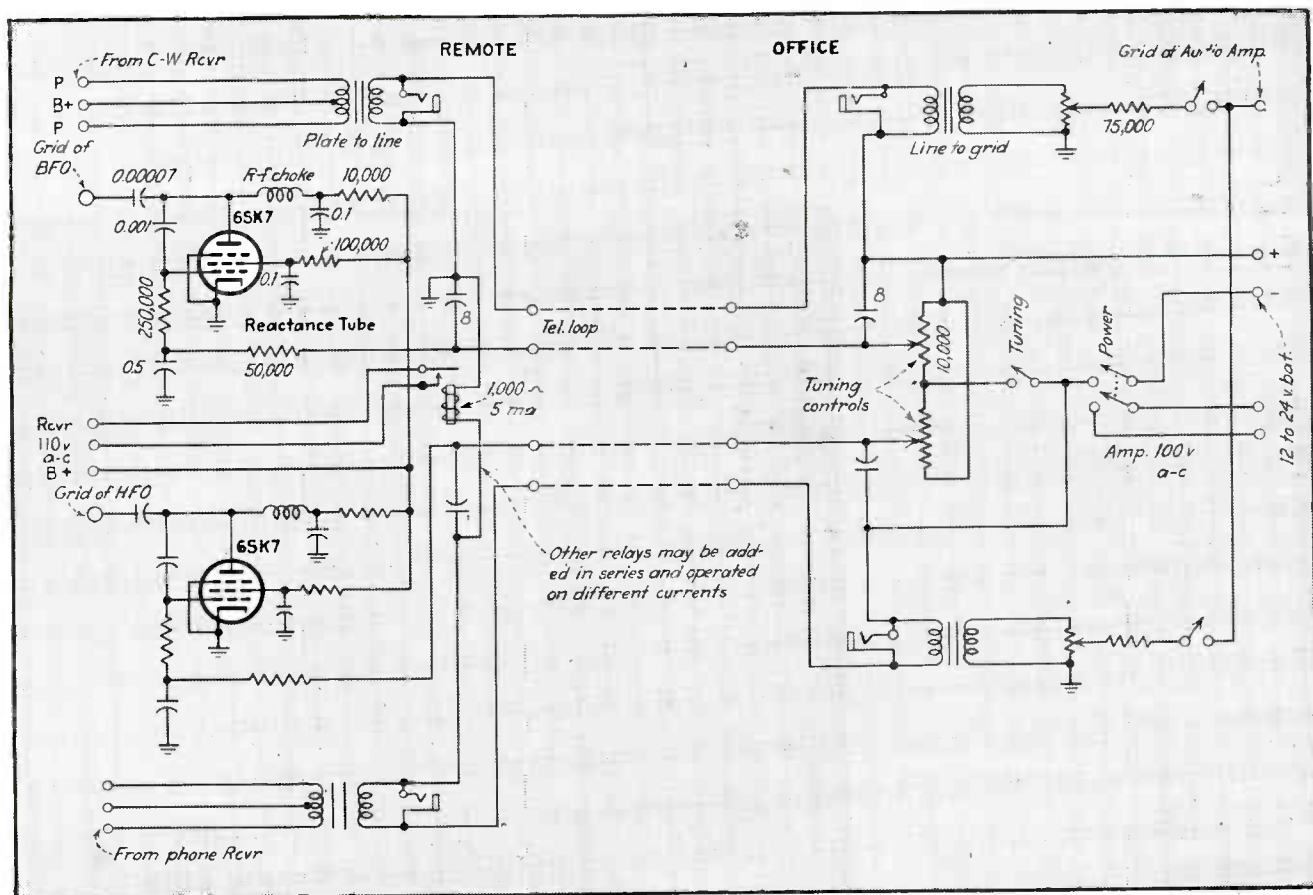

FIG. 2—Remote-tuning arrangement suitable for handling two receivers. Addition of other relays and another potentiometer permits a number of variations discussed in the text

# Electronic Control for

By exciting a magnetic clutch with a grid-controlled gaseous rectifier that is controlled by a governor generator through a bridge circuit having a vacuum tube in one leg, the output speed of a motor can be varied over a 100-to-1 range or a preset speed automatically maintained within 0.1 percent from no load to full load

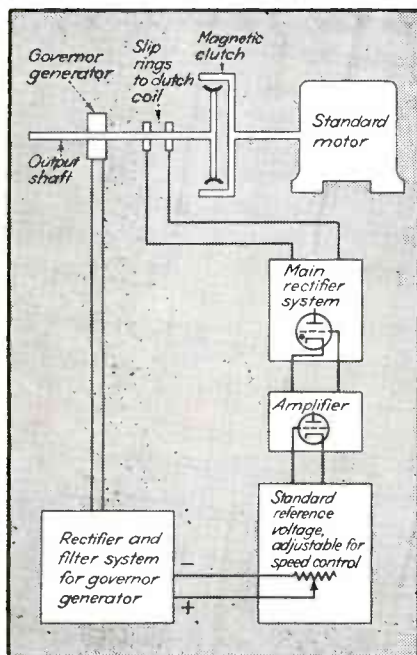

FIG. 1—Block diagram illustrating relationship between important elements of an electronically controlled variable-speed drive

**A**N electronically controlled magnetic clutch operating in conjunction with a standard a-c motor has proved highly successful as a means of controlling speed over a wide range and regulating the speed accurately at any desired value within this range. The flexibility of the clutch and the accuracy of the electronic control together make it possible to obtain speed reductions as high as 100 to 1, with the preset speed maintained within 1/10 of 1 percent for almost any load variation.

This electronically controlled drive has already been applied in connection with wind tunnels, dynamometers and superchargers in sizes from  $\frac{1}{4}$  hp up to 18,000 hp and

speeds of from 100 to 30,000 rpm. Machine tool manufacturers have also used this combination successfully when extreme speed ranges are required.

One motor car manufacturer, who is now making aircraft engines, uses the magnetic clutch for testing these engines. One end of the clutch is coupled to the aircraft engine, while the other end is connected to a synchronous alternator. The engine may run at any speed while the alternator runs at a fixed speed. The difference in speed is taken up in the clutch. The d-c excitation to the clutch is controlled

by an electronic rectifier system. In this manner, the major portion of the energy supplied by the aircraft engine is recovered, the remainder being dissipated as heat. When testing at speeds below that of the alternator, the alternator is stopped through the use of a friction brake, and the energy developed by the engine is entirely dissipated in the clutch.

#### Essential Elements of Electronic Drive

A functional diagram of the component elements of a variable-speed drive is shown in Fig. 1. Driving power is supplied to the magnetic

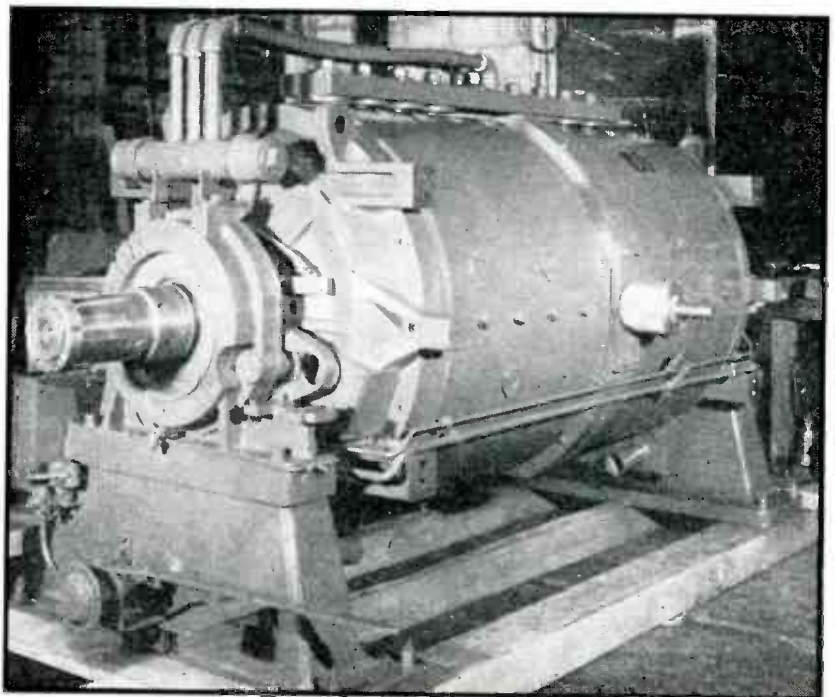

A 4,000-hp dynamometer whose power absorption is readily controlled by means of electronic speed-control equipment

# Magnetic Clutches

By **RALPH L. JAESCHKE**

*Dynamatic Corporation  
Kenosha, Wisconsin*

clutch by a standard motor. The output shaft of the clutch operates at some desired fraction of rotational speed, determined by the governor generator that feeds the electronic control system which provides excitation for the clutch. The success of the control mechanism depends upon (1) the production by the governor generator of a voltage that is exactly proportional to the speed of rotation of the output shaft, (2) an electronic control circuit that may be manually operated to adjust the speed to any desired value but which is entirely automatic and precise in operation for any given setting of the speed control, and (3) an electrically operated clutch mechanism responding to the resultant voltages from the manual speed control and the voltage from the governor generator. Each of these three units will be described separately.

## Characteristics of Governor Generator

A small a-c governor generator of the permanent-magnet type is placed on the output shaft of the clutch, as indicated in the block diagram of Fig. 1. The voltage of this generator is a linear function of rotational speed, as shown in Fig. 2, as is also the frequency of the a-c output.

The electronic control system requires for its proper functioning a direct voltage whose magnitude is proportional to the rotational speed of the output shaft. Accordingly, the output of the governor generator is fed into a full-wave rectifier with suitable filter. A d-c gener-

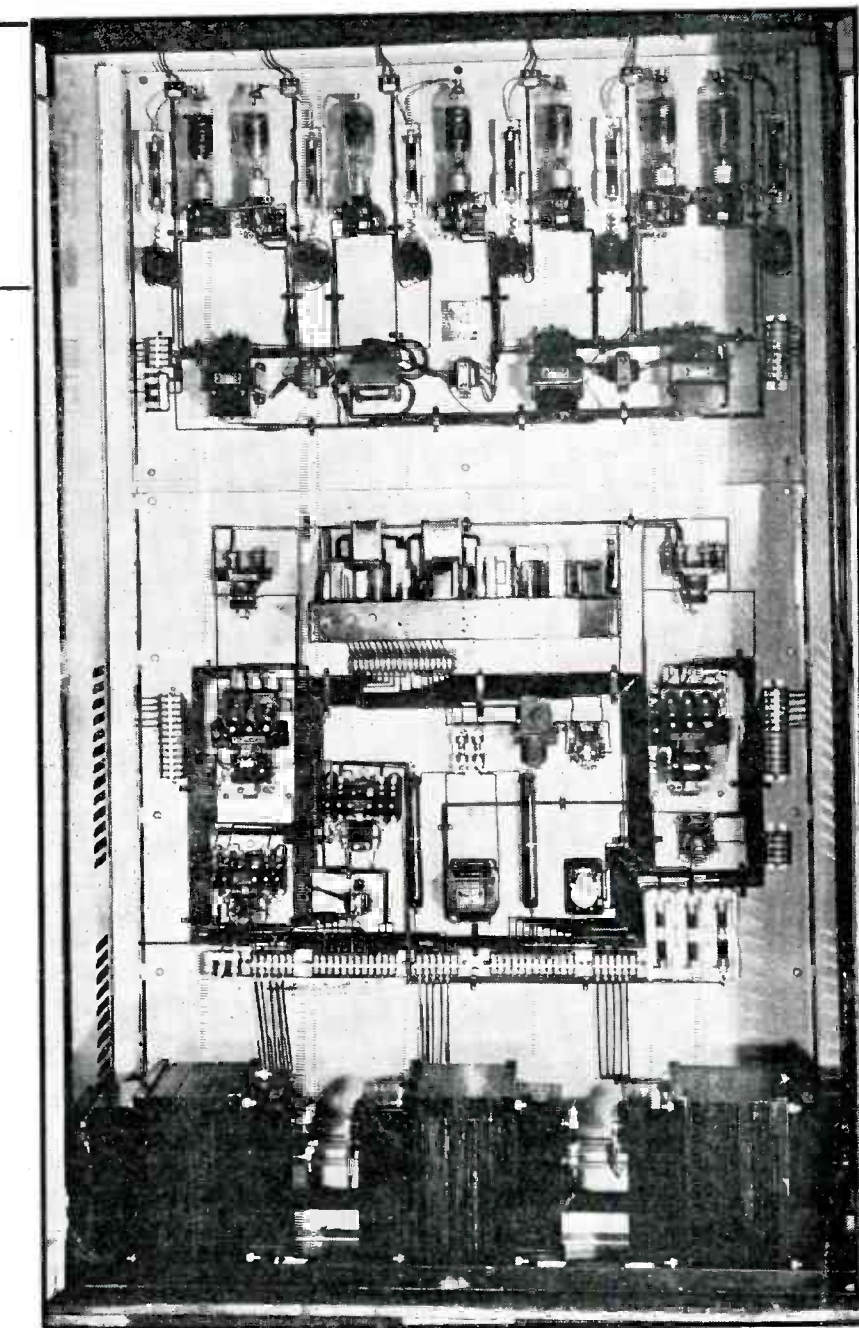

Rear view of control designed for providing 15-kw d-c excitation for 4,000-hp dynamometer

ator could be used in place of the a-c generator, thereby eliminating the rectifier and filter system, but considerable trouble with commutation, brush wear, electrical leaks to ground, and maintenance problems in this case makes the a-c governor more economical and desirable.

In practice the lowest frequency of the generator is 60 cps and the highest is about 4,000 cps except in cases where the clutch is operated at speeds as high as 30,000 rpm, when the maximum frequency is then approximately 15,000 cps. Rectification and filter problems are at a minimum at the higher frequen-

cies, thereby making it possible to obtain smoother operation with a small, low-cost filter system. Filters in a high-frequency circuit may cause erratic operation and hunting due to the time lag required to charge the capacitors.

**Electronic Control Scheme**

Voltage output from the rectifier-filter system fed by the governor generator is thus proportional to the output speed of the machine. Slight variations or changes in speed will result in proportionate changes in the output voltage of the governor generator system, and such variations may be used to regulate the clutch mechanism to control the speed of the output shaft. The necessary regulation and control is effected in the electronic circuits by comparing the voltage output of the governor generator system with a standard reference voltage which may be adjusted manually to give the desired speed.



Rear view of chassis using circuit of Fig. 4. This control unit supplies 220 watts of d-c excitation for machines of from 1 to 75 horsepower

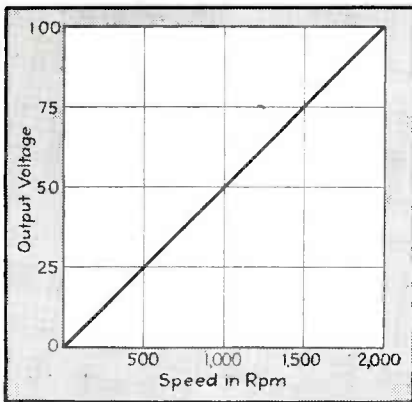

FIG. 2—Curve showing relations between speed of rotation and output voltage for typical governor generator

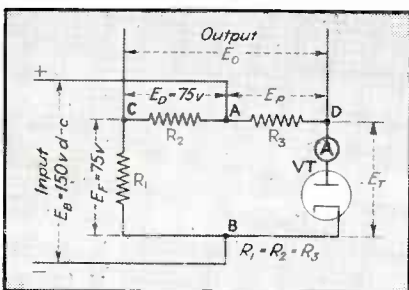

FIG. 3—Vacuum-tube bridge circuit which functions as control element for actuating the thyratrons feeding the magnetic clutch

The electronic control circuit is essentially a controlled rectifier using gaseous tubes, whose output power varies the excitation to the windings of the clutch.

The plates of the gaseous rectifiers are operated from an a-c source and the grids are fed by a one-stage vacuum-tube amplifier.

The grid of the amplifier tube is controlled by two variable electrical devices. One is known as the reference voltage, and is provided by a potentiometer connected across a d-c voltage source. This is usually termed a speed-setting control, since any predetermined setting of this control will cause the machine to run at a specified speed. The second voltage is obtained from the rectifier-filter system associated with the governor generator. These two voltages are connected in series opposition, and are of such magnitude that the signal voltage to the grid of the amplifier tube is zero when the output shaft is rotating at the desired speed. The signal voltage will be positive when the output shaft rotates faster than the desired speed, and will be negative

for speeds slower than the selected value.

**Reference Voltage**

The reference voltage is obtained from a transformer-rectifier-filter system operated from the line. Voltage stability is obtained through the use of voltage regulator tubes of the VR-150 or VR-105 type, although in cases where extreme constancy of voltage is required, an elaborate voltage regulator system is employed. The closer the reference voltage is held to a predetermined value, the better will be the speed control of the machine. The output of the voltage-regulating system is brought to a manually operated voltage divider which provides a convenient means for adjusting the machine to its required speed.

The sum of the two voltages, reference and governing, is then brought to the grid of a triode amplifier tube arranged as a driver for the final output tubes. This amplifier tube is in a balancing bridge circuit, similar to a Wheatstone bridge circuit, and is shown

in Fig. 3. The tube forms one arm of the bridge.

### Complete Circuit

Resistances  $R_1$ ,  $R_2$ , and  $R_3$  are of equal value. Therefore, when the cathode-plate resistance of the triode is equal to  $R_1$ , the bridge is balanced and the output voltage  $E_o$  is zero. When the triode does not pass current, no voltage drop will exist across  $R_3$ . In this case a voltage drop, equal to one half that applied across  $AB$ , will exist across  $R_2$ . Point  $C$  will then be more negative than  $A$  by the voltage drop across  $R_2$ . This voltage drop will appear as  $E_p = E_o$  since  $E_p = 0$  now, and will be applied to the grid of the gaseous controlled rectifier.

Should the signal on the grid of amplifier tube  $VT$  be positive, a voltage drop  $E_r$ , whose magnitude depends upon the plate impedance of the tube as well as upon the grid voltage of  $VT$ , will appear as the result of current passing through the tube. This will cause a voltage drop across  $R_3$  which will be greater than that across  $R_2$ . Point  $D$  will be more negative than points  $A$  and  $C$ . Since the voltages developed across  $R_2$  and  $R_3$  are in opposition, the difference  $E_o$  will have a polarity opposite to that obtained in the previous case. This will cause the grid of the controlled rectifier to become negative, causing the current developed in its load to drop to zero. For instance, if the tube drop  $E_r$  is 10 volts, then  $E_p$  is 140 volts and  $E_o$  is  $E_o = E_p - 10 = 130$  volts since polarity is in opposition.

In the more complete electronic speed-control circuit diagram of Fig. 4, this bridge is represented by tube  $VT_7$  and resistors  $R_{12}$ ,  $R_{13}$ , and  $R_{20}$ . The voltage  $E_B$  supplying the bridge is obtained from a transformer-rectifier-filter power supply employing a 5U4 full-wave rectifier tube. The output of the bridge circuit,  $E_o$ , is applied between the grid and cathode of gaseous controlled rectifier  $VT_2$ .

The half-wave grid-controlled gaseous rectifier  $VT_2$  is connected across the clutch-coil load along with an uncontrolled gaseous rectifier,  $VT_1$ . Since the load is highly

inductive, it is necessary to keep the high inverse voltages to a minimum in order to protect the insulation of the clutch coil and eliminate the destructive effects on the grid-controlled tube.

The gas type of grid-controlled tube was used because of its many advantages over the mercury type. Its cost is somewhat lower; it is not as large since it does not have to have a cold spot for condensation and, most important of all, its grid characteristics do not change with temperature as in the case of the mercury tube.

Should the machine be set to run at 1000 rpm by speed control volt-

age divider  $R_{17}$ , the reference voltage developed by  $VT_4$  and regulated by  $VT_5$  and  $VT_6$  will be equal to the voltage developed by full-wave rectifier  $VT_3$  when fed by the governor generator running at 1000 rpm.

With the output shaft of the clutch at rest but the driving member rotating, no voltage will be generated by the governor generator. As soon as speed control  $R_{17}$  is moved above zero speed, it will cause the grid of  $VT_7$  to become more negative, allowing final output rectifier tube  $VT_2$  to become positive and pass current through the clutch. This will start the pilot

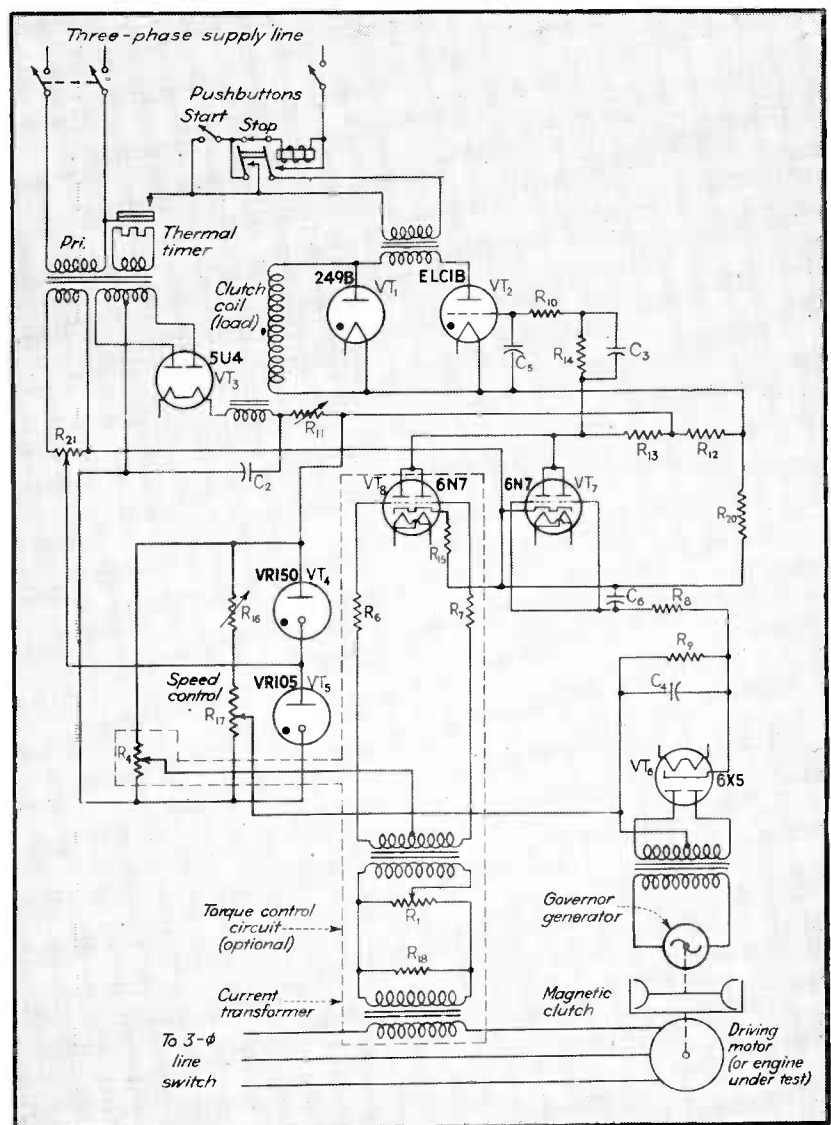

FIG. 4—Schematic wiring diagram of complete variable-speed drive unit. Tube  $VT_7$  and its associated circuits form the bridge circuit illustrated in Fig. 3. The portion enclosed in dotted lines is the optional torque control circuit

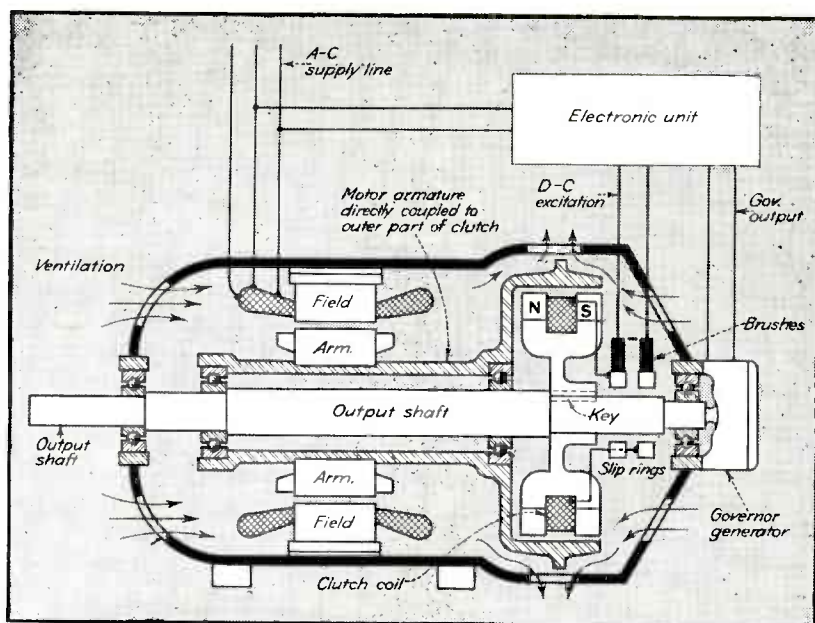

FIG. 5—Cross-sectional diagram illustrating construction of magnetic clutch

generator rotating, and it in turn will cause the grid of  $VT_1$  to be driven in a positive direction. Balance is reached when the governor generator reaches the preset speed. If additional mechanical load causes the speed to drop below this value, the grid of  $VT_1$  swings more negative and  $VT_1$  passes still more clutch excitation in an effort to maintain its preset speed.

#### Combined Motor and Clutch Unit

The cross-section view in Fig. 5 shows the construction of a combination a-c motor and adjustable-speed magnetic clutch built as a single unit. The field poles of the motor are fixed in position. The armature of the motor and the outer magnetic circuit of the clutch rotate as an integral unit at the fixed rated speed of the motor, while the output shaft and the inner part of the clutch (carrying the clutch coil and the slip rings for bringing d-c energizing power to this coil) rotate at the desired output speed as maintained by the governor generator on the output shaft and the clutch-energizing electronic unit.

The output speed of a magnetic clutch-motor system is usually a function of d-c excitation current and load. At a fixed load and excitation, the speed output would remain fixed, the deviations being the

result of temperature changes and air gap clearance in the clutch. In some cases, fixed excitation is sufficient for speed control, due to natural characteristics of the clutch.

To maintain a speed when the torque is changed, it is necessary to vary the excitation to the clutch. If the torque requirement is increased, the excitation must be increased to maintain the speed; therefore the use of an electronically controlled excitation source whose output is based on speed is desirable. This control is so arranged that, when the speed decreases from a predetermined setting, the excitation current increases; or, when the speed increases, the current output decreases.

A change in the clutch excitation causes a practically instantaneous change in the torque being developed. The accompanying change in speed will depend upon the change in torque and also the inertia of the connected load.

#### Torque Control

In many cases, the rate of acceleration must be limited, or in the case of loads which have a very high moment of inertia, a torque-limiting system is required. Torque control may be adapted to any excitation unit applied to a clutch used in conjunction with an a-c motor. This is done through the

use of an additional circuit, shown inclosed in dotted lines in Fig. 4. Voltage obtained from a current transformer inserted in one motor lead is transmitted to amplifier tube  $VT_2$ , which is arranged to limit the quantity of d-c excitation to the clutch when a predetermined voltage, determined by the setting of  $R_1$ , is reached.

The torque control circuit will take over when a sudden speed change is made by the speed-setting control provided the horsepower output limitations of the motor are exceeded, thereby effecting gradual acceleration. In order to make the torque limit adjustable, a small voltage divider  $R_1$  is placed in the current transformer circuit so that the machine setting may be easily adjusted.

#### Anti-Hunt Circuits

The success of such an electrical-mechanical system depends upon the anti-hunt circuit used. A capacitor-resistor combination  $R_1$  and  $C_3$ , whose time constant must be equal to the time constant of the machine, is used for this purpose. To operate such a system without an anti-hunt circuit, it is necessary to make the system very broad or inefficient with the result that the fine speed control characteristics are lost.

#### Applications

The same speed control may be applied to dynamometers, the only difference being that the function is reversed. Instead of driving some device, the dynamometer is driven. Should the speed tend to increase over a preset limit, the excitation current would increase, causing more horsepower to be absorbed in the dynamometer, and the torque would be shown on a suitable scale.

Electronic variable speed control mechanisms are available as standard equipment for motors of from 1 to 75 hp rating. A cabinet-mounted d-c exciting unit has also been designed to control the speed of a 4000-hp dynamometer. The same electronic control system may be successfully applied to rotating equipment covering an unusually wide range of power ratings.

# F-M Antenna Coupler

An f-m antenna at the top of a base-insulated tower used as an a-m radiator is fed through a concentric line without short-circuiting the tower. The coupling unit which accomplishes this is described in detail

By JOHN P. TAYLOR

*RCA Victor Div.  
Radio Corp. of America  
Camden, N. J.*

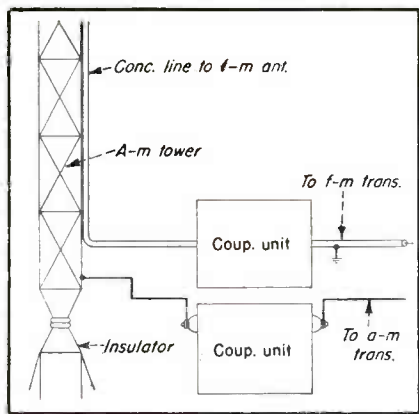

FIG. 1—To avoid short-circuiting the base-insulated a-m tower and to prevent a-m power from feeding back into the f-m transmitter an f-m coupling unit is used. In this instance it is mounted adjacent to an a-m coupling unit at the base of the tower

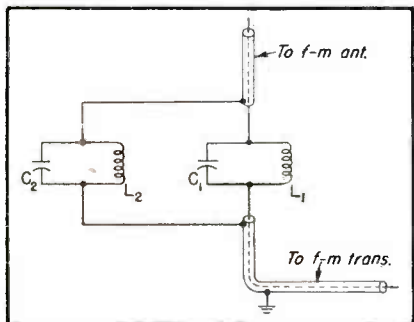

FIG. 2—Breaking the concentric f-m antenna feeder and inserting circuits resonant at the a-m frequency provides isolation at the a-m frequency

**W**HEN an f-m antenna is mounted on a tower which is used as an a-m antenna it is necessary to provide an f-m coupling unit at the base of the tower. If the tower is of the insulated type, this coupling unit has two functions. The first of these functions is to pass the f-m feed line around the tower insulator without short-circuiting the latter at the a-m frequency. The second function of the coupling unit is to prevent r-f energy at the a-m frequency from passing back down the f-m feed line into the f-m transmitter and causing crosstalk at the f-m frequency. If the a-m tower is of the grounded type only the latter function is involved.

Various circuits suitable for use in f-m coupling units have been proposed. In a particular case, the circuit used depends largely upon the size and availability of the re-

quired components. This, in turn, depends chiefly upon the voltage across the tower insulator at the a-m frequency. Thus it is not possible to design an f-m coupling unit which will satisfactorily meet the requirements of all installations, any more than it would be possible to develop a universal a-m coup-

ling unit. However, the fundamental problem is the same in all cases, and some useful ideas on the best method of solving it can be obtained by studying typical installations. One of these, the f-m coupling unit at WBRL, Baton Rouge, will be described here.

The f-m antenna of WBRL<sup>1</sup> is



The concentric line feeding WBRL's square-loop f-m antenna at the top of WJBO's a-m tower is purposely left loose to allow for expansion and contraction. The line may be seen running up from the right

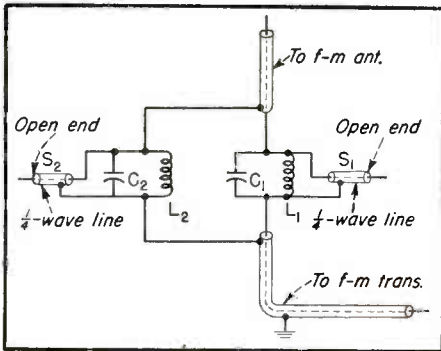

FIG. 3—Open-ended concentric lines  $S_1$  and  $S_2$  provide a low-impedance path for the f-m power

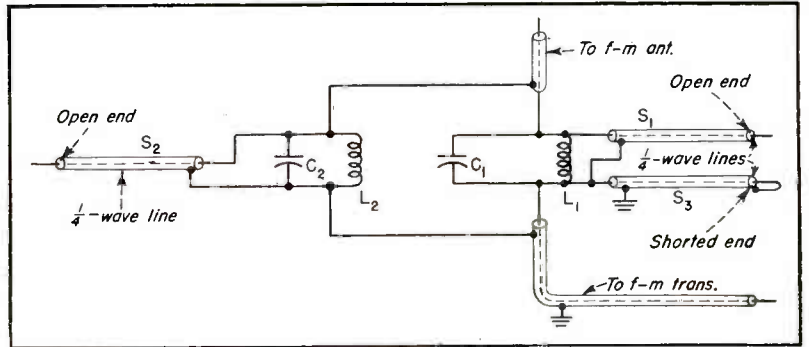

FIG. 4—In the final f-m coupler circuit quarter wave length line  $S_3$  is added in order to effectively ground the lower end of circuit  $C_1L_1$  with respect to a-m power. This line is shorted at its far end

mounted on the top of a 500-ft insulated, self-supporting tower which is the central tower of the three-tower directive antenna array of a-m station WJBO. The latter operates at 5 kw on a frequency of 1180 kc. At this frequency the tower is approximately a half wavelength high. Thus for daytime operation (non-directive) when power is fed to this one tower only, the base impedance is quite high. The f-m coupling unit must operate satisfactorily for this condition, as well as for the condition of nighttime operation (directional) when all three towers are used.

#### The Coupling Problem

The f-m coupling unit is located adjacent to the a-m coupling unit at the base of the tower, as shown in Fig. 1. The line from the f-m coupling unit back to the f-m transmitter in the station building is a concentric line with its outer conductor grounded. If the outer conductor of the part of the f-m line running from the f-m coupling unit to the tower were also grounded, the tower insulator would be short-circuited. The first step, therefore, is to break both the outer and inner conductors of the concentric line and insert blocking circuits as shown in Fig. 2. Here,  $L_1$  and  $C_1$  form a parallel-resonant circuit tuned to present a very high impedance at the a-m frequency. Components  $L_2$  and  $C_2$  perform a similar function.

At the f-m frequency, the blocking circuits have a lower but not entirely negligible value of imped-

ance which it is desirable to bypass. To do this, concentric lines  $S_1$  and  $S_2$  are connected across these circuits as shown in Fig. 3. These open-ended lines present extremely low-impedances at their near ends when tuned to  $\frac{1}{4}$ -wavelength at the f-m frequency and therefore, provide the required bypassing. Insofar as the a-m frequency is concerned, lines  $S_1$  and  $S_2$  simply represent small capacitances in parallel with  $C_1$  and  $C_2$  and can be lumped in with these in the tuning operation.

Only one more element is needed to complete the f-m coupling arrangement, namely, the addition of a grounding line  $S_3$ , as shown in Fig. 4. This is a quarter-wavelength of concentric line shorted at the far end. Such a line presents an infinite impedance at the near end. Thus, when the outer conductor of line  $S_3$  is grounded and the inner conductor connected to the bottom of  $L_1C_1$  there is no short-circuit with respect to f-m transmission. At the a-m frequency, however, this length of concentric line is rela-

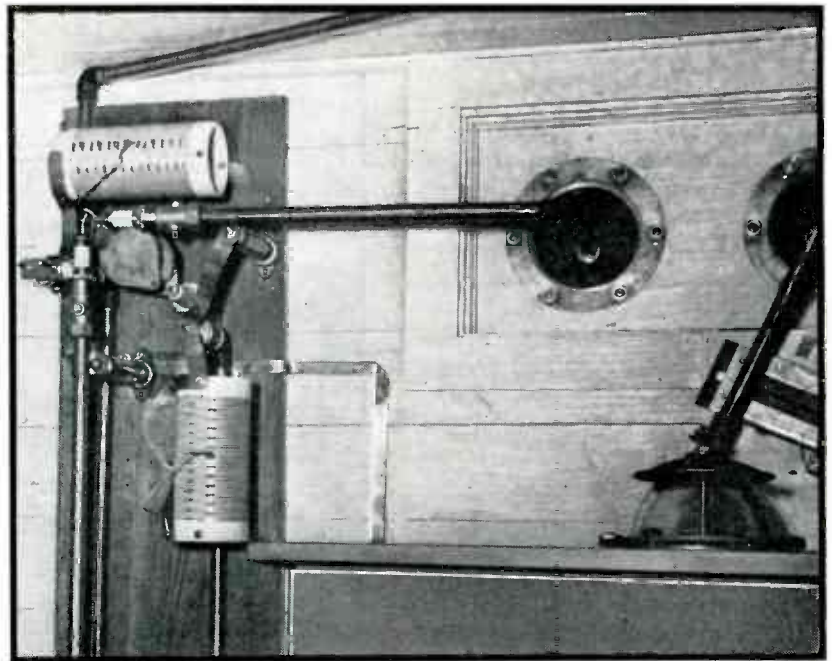

FIG. 5—The f-m coupling unit, mounted on a baseboard inside a doghouse at the bottom of the tower. The concentric line from the f-m transmitter comes in diagonally at the top. The concentric line from the coupler to the f-m antenna goes out through a bowl-insulator. Lines  $S_1$ ,  $S_2$  and  $S_3$  drop down from the tuned circuits at the left. The a-m coupler is within the steel cabinet, the top of which is visible in the foreground, and the a-m feeder may be seen passing out through a bowl-insulator at the extreme right



tively very short and, therefore, the bottom of  $L_1C_1$  is effectively grounded at a-m frequency. This makes the blocking action of the circuit  $L_1C_1$  much more effective.

#### Construction of the Coupling Unit

The components of the f-m coupling circuit are grouped on a baseboard which is approximately 1½-ft wide and 6-ft long. This assembly is mounted on the wall inside a doghouse adjacent to the a-m coupling unit, as shown in Fig. 5.

The ⅜-inch concentric line from the f-m transmitter, which is located in the transmitter house some 300 ft away crosses the ceiling of the doghouse at an angle and enters the f-m coupling unit at the top. The ⅜-inch concentric line to the f-m antenna leaves the unit on the right side near the top and passes out of the doghouse through a glass bowl insulator. This insulator is the same type as that through which passes the ⅜-inch copper pipe that forms the a-m antenna feed line.

Outside, f-m and a-m lines run side by side to the lowest brace of the tower, as shown in Fig. 6 and Fig. 7. At the tower, the pipe which forms the a-m line is solidly attached, while the f-m line continues on up the side of the tower.

Capacitors  $C_1$  and  $C_2$  are Type 77 Faradons. Inductances  $L_1$  and  $L_2$  consist of 53 turns of No. 12 solid wire, tapped every second turn. The three quarter-wave lines extend down along the baseboard. Since the outer conductors of two of these ( $S_2$  and  $S_3$ ) are grounded anyway, these two are mounted directly on the board. The third ( $S_1$ ) is above ground, hence is mounted on insulators.

#### Tuning Procedure

Tuning of the coupling circuits is a two-step process, since adjustments must be found that permit the network to operate as required at both the a-m and f-m frequencies. Since the length of the lines  $S_1$  and  $S_2$  affects the a-m tuning as well as the f-m tuning, whereas the settings of  $L_1C_1$  and  $L_2C_2$  affect the a-m tuning only, it is necessary to make the f-m adjustment first.

The procedure in tuning for the f-m frequency is as follows: A 10-watt crystal-controlled r-f gener-

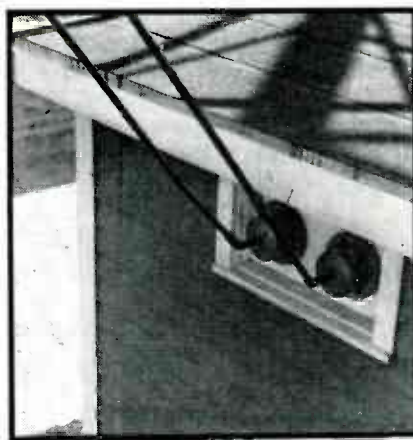

FIG. 6—Seen from outside the doghouse: Concentric f-m line at the right and a-m feeder at the left. Tower lighting lines are carried up inside the a-m feeder



FIG. 7—The a-m line, at the right, terminates at the first tower-brace. A copper bond runs around the tower at this point. The f-m line continues up the tower

ator operating at the f-m frequency is connected to the input of the network where the line from the f-m transmitter normally connects. A 70-ohm load in series with an r-f milliammeter is connected to the output of the network, where the line to the antenna is normally connected. The lengths of the lines  $S_1$  and  $S_2$  are then varied until placing a direct short across the near end of either of these lines produces no change in the output-meter reading. The length of line  $S_3$  is next varied until connecting or dis-

connecting this line from the network has no effect on the meter reading. In other words, all three lines are adjusted so that they act like quarter-wave lines electrically even though they are physically somewhat shorter than a quarter-wave due to end effects and the lumped capacitance of the end seals. With the adjustments thus made, the f-m energy passes through the coupling network without power loss and without causing reflections on the line.

The procedure in tuning for the a-m frequency is as follows: First, the two parallel circuits  $L_1C_1$  and  $L_2C_2$  are adjusted approximately to resonance at the a-m frequency, using a low power oscillator as a driving source. Second, the network is disconnected from the concentric-line section feeding the antenna. The a-m transmitter is turned on, the a-m coupling circuit tuned and the a-m antenna current noted. Third, the outer conductor of the concentric line section running up the tower is reconnected and the change in the a-m antenna-meter reading noted. By slight readjustment of the tap on  $L_2$ , a point is found at which making and breaking the connection to the outer conductor of the line has no effect on the reading of the a-m antenna meter. Fourth, the inner conductor of the concentric line running up the tower is reconnected to the network and  $L_1$  is adjusted until connecting and reconnecting has no effect on the a-m meter reading. When this is achieved the f-m line has no effect on a-m operations.

As a final check on the operation of the WBRL coupling unit, two types of field tests were made. The field intensity of the a-m station, WJBO, was carefully measured, using an RCA 308-A Field Intensity Meter, at several points—both with and without the f-m network connected to the tower. No difference could be noted. Also, extended observations of both the a-m and f-m signals were made, with high modulation and low modulation levels, using a high-quality receiver. No trace of cross-talk or cross-modulation was noted.

#### REFERENCES

- (1) Taylor, John P., A Square-Loop F-M Antenna. *ELECTRONICS*, 18, p. 96-100, March, 1945.

# Induction and Dielectric HEATING EQUIPMENT

Tabular comparison of technical characteristics and initial cost per kilowatt of output power for commercially available induction and dielectric heating equipment, as reported to *ELECTRONICS* by manufacturers. Both electronic and non-electronic types are covered

**P**RIOR TO THE ENTRY of the United States into World War II, practically all high-frequency heating was accomplished with experimental or custom-built units. However, the requirements of war production and the greater general acceptance of electronic devices opened new market possibilities until now there is available a wide-range of high-frequency heating equipment in standard commercial models. In addition, custom-built and special units are available from nearly all of the standard commercial-model manufacturers to meet special requirements.

Applications for high-frequency heating divide into two distinct groups: (1) induction heating units for melting, hardening, brazing, soldering, and heat treatment of metallic and conducting materials, and (2) dielectric heating units for heating, dehydrating, sterilization, or cooking of non-conducting materials such as tobacco, wood products, food, agricultural products, cereals, and the like. In some cases a given high-frequency heating unit may be used for either dielectric or induction heating. However, it is more general practice to designate a unit as a dielectric heating unit or an induction heating unit since the frequency range, circuit design, and power output electrodes differ rather widely in the two types of applications.

Four different types of equipment are in common use: (1) rotating machines, producing frequencies up to about 10,000 cycles per second and suitable only for induction heating, (2) mercury-arc frequency converters by which power at ordinary power line fre-

quencies is converted into frequencies in the range of 1,000 to 3,000 cps, (3) spark-gap equipment in which a-c power is converted into oscillations at frequencies that can range from about 10 to 500 kc, by means of a high-voltage transformer, spark gap, and oscillatory tuned circuits, and (4) vacuum-tube oscillators in which the conversion from power-line frequencies to frequencies ranging from about 50 kc to 200 Mc is effected by air or water-cooled vacuum-tube oscillators.

## Performance Comparisons

The primary purpose of this survey is to promote more extensive use of high-frequency industrial heating equipment by providing (so far as possible) a listing of the more important technical characteristics of various types of available commercial equipment (Table I). Unfortunately, available technical data on commercial units cannot always be correlated on a comparable basis.

The nominal power input values required for full rated load are given in the table where this data was available, with these input values being for optimum load matching in most instances. The

no-load power input to the equipment is usually considerably less than the nominal power input value given and for tube equipment may be of the order of about 10 percent of the value given. The power input may be considerably varied by the power factor of the system, the power output and effectiveness of the load coupling method.

The power output given is the maximum nominal power output under load conditions, assuming efficient coupling between the generator and load. When the duty cycle is such that maximum output power is used only a small fraction of the time, output ratings may be exceeded with some units.

The rotating machine types and the mercury-arc frequency converter operate at audio frequencies, with the highest value for rotating machines being about 10,000 cps at present. Such low frequencies are used for induction melting of metals and for induction heating throughout the entire mass of conducting materials.

Most of the vacuum-tube equipment for induction heating operates either at frequencies between 100 and 500 kc or in the region from 2 to 5 Mc. The lower frequency band is usually employed for surface heating operations, case hardening and similar applications.

In dielectric heating generators the operating frequency is usually in the neighborhood of 20 to 30 Mc, although equipment operating up to 200 Mc is available.

Most manufacturers supply the necessary accessories such as output coils, work tables, and similar equipment, in order to assure that the installation operates satisfactorily and efficiently. At the pres-

**TABLE II. COST-PER-KW COMPARISON FOR EQUIPMENT**

Power Output in kw	Vacuum Tube Units	Other Types	
1	\$1200 to \$2200	Spark gap units cost \$150 to \$250 per kw up to 20 kw	
2	\$500 to \$1500		
5	\$250 to \$1000		
10	\$250 to \$1000		
20	\$250 to \$700		
50	\$150 to \$700		
100	\$100 to \$500		
200			Rotating machines cost \$50 to \$200 per kw from 50 to 1000 kw
500			
1000			

TABLE I—MANUFACTURERS OF INDUCTION AND DIELECTRIC HEATING EQUIPMENT

Name of Manufacturer	Type of Heating	Generator	Power Input	Power Output	Output Frequency	Name of Manufacturer	Type of Heating	Generator	Power Input	Power Output	Output Frequency		
Ajax Electrothermic Corp., Ajax Park, Trenton, N. J.	Induction	Spark Gap	3 kw	2 kw	40-80 kc	Induction Heating Corporation, 389 Lafayette St., New York, N. Y.	Induction	Vac. Tube	20 kva	10 kw	375 kc		
	Induction	Spark Gap	6 kw	4 kw	40-80 kc		Induction	Vac. Tube	38 kva	20 kw	375 kc		
	Induction	Spark Gap	20 kw	15 kw	10-40 kc		Induction	Vac. Tube	76 kva	40 kw	375 kc		
	Induction	Spark Gap	40 kw	30 kw	10-40 kc		Dielectric	Vac. Tube	10 kva	3.5 kw	10-35 Mc		
	Induction	Rot. Mach.	—	50 kw	1, 3, or 10 kc		Dielectric	Vac. Tube	20 kva	12.5 kw	10-35 Mc		
	Induction	Rot. Mach.	—	100 kw	1, 3, or 10 kc		Intra-Therm Corp., Third and Keo Way, Des Moines 9, Iowa Vacuum tube types for dielectric heating, in sizes ranging from 1 to 250 kw output power and frequencies from 10 to 100 Mc						
	Induction	Rot. Mach.	—	175 kw	1, 3, or 10 kc		Lepel High Frequency Laboratories, 39 West 60th St., New York, N. Y.	Induction	Spark Gap	4 kw	2.8 kw	150-450 kc	
	Induction	Rot. Mach.	—	250 kw	1, 3, or 10 kc			Induction	Spark Gap	7.5 kw	5.2 kw	150-450 kc	
	Induction	Rot. Mach.	—	350 kw	1, 3, or 10 kc			Induction	Spark Gap	15 kw	10.5 kw	150-450 kc	
Induction	Rot. Mach.	—	700 kw	1, 3, or 10 kc	Induction	Spark Gap		30 kw	21 kw	150-450 kc			
Induction	Rot. Mach.	—	1200 kw	1, 3, or 10 kc	Induction	Vac. Tube		2.2 kw	—	350 kc			
Allis-Chalmers Mfg. Co., Milwaukee, Wisc.	Induction	Merc. Arc	—	300 kw	1000-3000 cps	Dielectric		Vac. Tube	0.5 kw	150 w	80 Mc		
	Induction	Merc. Arc	—	600 kw	1000-3000 cps	Dielectric		Vac. Tube	2.2 kw	900 w	14 Mc		
	Induction	Merc. Arc	—	750 kw	1000-3000 cps	Dielectric		Vac. Tube	5 kw	2.3 kw	14 Mc		
	Induction	Merc. Arc	—	1000 kw	1000-3000 cps	Ohio Crankshaft Co., 3800 Harvard Ave., Cleveland, Ohio		Induction	Rot. Mach.	15 hp	7.5 kw	9600 cps	
	Induction	Vac. Tube	35 kva	20 kw	400-500 kc		Induction	Rot. Mach.	25 hp	15 kw	9600 cps		
	Induction	Vac. Tube	65 kva	50 kw	400-500 kc		Induction	Rot. Mach.	50 hp	30 kw	9600 cps		
Induction	Vac. Tube	130 kva	100 kw	400-500 kc	Induction		Rot. Mach.	90 hp	50 kw	9600 cps			
American Type Founders, Inc., Heating Division, Union City, N. J.	Induction	Spark Gap	16 kw	15 kw	100-300 kc		Induction	Rot. Mach.	130 hp	75 kw	9600 cps		
	Induction	Spark Gap	—	30 kw	—		Induction	Rot. Mach.	175 hp	100 kw	9600 cps		
	Barker & Williamson, 235 Fairfield Ave., Upper Darby, Pa. Vacuum tube types up to 25 kw output, for both induction and dielectric heating, on a custom basis only at present.						Induction	Rot. Mach.	225 hp	125 kw	9600 cps		
Badd Induction Heats, Inc., 11811 Charlevoix Ave., Detroit 14, Mich.	Rotating types for induction heating, on a custom basis at present, including complete accessories and tooling.						Radio Corp. of America, RCA Victor Division, Camden, New Jersey	Dielectric	Vac. Tube	800 w	100 w	200 Mc	
	Ecco High Frequency Electric Corp., 7020 Hudson Blvd., North Bergen, N. J.	Induction	Spark Gap	3.5 kva	—			50-500 kc	Induction	Vac. Tube	2.2 kw	750 w	400 kc
Induction		Spark Gap	5.5 kva	—	50-500 kc	Dielectric	Vac. Tube	5.5 kw	2 kw	27.4 Mc			
Induction		Spark Gap	8 kva	—	50-500 kc	Induction	Vac. Tube	5.5 kw	2 kw	400 kc			
Induction		Spark Gap	10 kva	—	50-500 kc	Dielectric	Vac. Tube	40 kw	15 kw	2, 5, or 10 Mc			
Induction		Spark Gap	16 kva	—	50-500 kc	Induction	Vac. Tube	40 kw	15 kw	400 kc			
Induction		Spark Gap	20 kva	—	50-500 kc	Dielectric	Vac. Tube	110 kw	60 kw	13.7 Mc			
Induction		Spark Gap	35 kva	—	50-500 kc	Induction	Vac. Tube	135 kw	75 kw	400 kc			
Induction		Spark Gap	105 kva	—	50-500 kc	Dielectric	Vac. Tube	225 kw	125 kw	13.7 Mc			
Induction		Vac. Tube	—	5 kw	50-500 kc	Induction	Vac. Tube	260 kw	150 kw	400 kc			
Induction		Vac. Tube	—	25 kw	50-500 kc	Radio Receptor Co., 251 West 19th St., New York, N. Y.	Dielectric	Vac. Tube	—	500 w	5, 15, or 30 Mc		
Federal Electric Co., Inc., Chicago	Induction	Vac. Tube	10 kva	5 kw	450 kc		Dielectric	Vac. Tube	—	1 kw	5, 15, or 30 Mc		
	Induction	Vac. Tube	32 kva	15 kw	450 kc		Dielectric	Vac. Tube	—	2.5 kw	5, 15, or 30 Mc		
Federal Telephone & Radio Corp., 591 Broad St., Newark, N. J.	Dielectric	Vac. Tube	2 kva	1 kw	27 Mc		Dielectric	Vac. Tube	—	5 kw	5, 15, or 30 Mc		
	Dielectric	Vac. Tube	6 kva	3 kw	15 Mc		Dielectric	Vac. Tube	—	7.5 kw	5, 15, or 30 Mc		
	Dielectric	Vac. Tube	14 kva	7 kw	15 Mc	Dielectric	Vac. Tube	—	15 kw	5, 15, or 30 Mc			
	Dielectric	Vac. Tube	30 kva	15 kw	27 Mc	Dielectric	Vac. Tube	—	30 kw	5, 15, or 30 Mc			
	Dielectric	Vac. Tube	50 kva	25 kw	15 Mc	"S" Corrugated Quenched Gap Co., Scientific Electric Division, 111 Monroe St., Garfield, N. J.	Dielectric	Vac. Tube	—	3 kw	15-40 Mc		
	Induction	Vac. Tube	5 kva	3 kw	15 Mc		Dielectric	Vac. Tube	—	5 kw	15-40 Mc		
	Induction	Vac. Tube	14 kva	7 kw	9-15 Mc		Dielectric	Vac. Tube	—	8 kw	15-40 Mc		
	Induction	Vac. Tube	50 kva	25 kw	2-5 Mc		Induction	Vac. Tube	—	5 kw	200-600 kc		
	Induction	Vac. Tube	14 kva	7 kw	9-15 Mc		Induction	Vac. Tube	—	7.5 kw	200-600 kc		
	Induction	Vac. Tube	50 kva	25 kw	2-5 Mc		Induction	Vac. Tube	—	10 kw	200-600 kc		
Induction	Vac. Tube	50 kva	25 kw	350 kc	Induction		Vac. Tube	—	12.5 kw	200-600 kc			
Induction	Vac. Tube	100 kva	50 kw	2-5 Mc	Induction		Vac. Tube	—	18 kw	200-600 kc			
Induction	Vac. Tube	100 kva	50 kw	350 kc	Induction		Vac. Tube	—	25 kw	200-600 kc			
Induction	Vac. Tube	150 kva	75 kw	2-5 Mc	Induction		Vac. Tube	—	40 kw	200-600 kc			
Girdler Corp., Thermex Division, 224 E. Broadway, Louisville, Ky.	Dielectric	Vac. Tube	—	0.4 kw	—	Induction	Vac. Tube	—	60 kw	200-600 kc			
	Dielectric	Vac. Tube	—	0.6 kw	—	Westinghouse Electric Corp., East Pittsburgh, Pa.	Ind. & Diel.	Vac. Tube	—	1 kw	300 kc & 10 Mc		
	Dielectric	Vac. Tube	—	0.75 kw	—		Dielectric	Vac. Tube	6.25 kva	2 kw	5, 15, or 30 Mc		
	Dielectric	Vac. Tube	—	1.2 kw	—		Ind. or D.	Vac. Tube	11 kva	5 kw	0.45, 5, 15, or 30 Mc		
	Dielectric	Vac. Tube	—	1.5 kw	—		Ind. or D.	Vac. Tube	21 kva	10 kw	0.45, 5, 15, or 30 Mc		
	Dielectric	Vac. Tube	—	4 kw	—		Ind. or D.	Vac. Tube	43 kva	20 kw	0.45, 2, or 10 Mc		
	Dielectric	Vac. Tube	—	4.5 kw	—		Induction	Vac. Tube	95 kva	50 kw	0.45 Mc		
	Dielectric	Vac. Tube	—	8 kw	—		Induction	Rot. Mach.	—	50 kw	3000 & 9600 cps		
	Dielectric	Vac. Tube	—	16 kw	—		Induction	Rot. Mach.	—	75 kw	9600 cps		
	Dielectric	Vac. Tube	—	25 kw	—		Induction	Rot. Mach.	—	100 kw	3000 & 9600 cps		
Dielectric	Vac. Tube	—	150 kw	—	Induction		Rot. Mach.	—	125 kw	9600 cps			
Illinois Tool Works, 2501 N. Keeler Ave., Chicago 39, Illinois	Dielectric	Vac. Tube	—	1 kw	—	Induction	Rot. Mach.	—	150 kw	3000 cps			
	Dielectric	Vac. Tube	3.8 kw	2.5 kw	10-27 Mc	Induction	Rot. Mach.	—	200 kw	3000 cps			
	Dielectric	Vac. Tube	9 kw	5 kw	10-27 Mc	Westinghouse Electric Corp., East Pittsburgh, Pa.	Ind. & Diel.	Vac. Tube	—	1 kw	300 kc & 10 Mc		
	Dielectric	Vac. Tube	35 kw	20 kw	10-27 Mc		Dielectric	Vac. Tube	6.25 kva	2 kw	5, 15, or 30 Mc		
	Induction	Vac. Tube	—	1 kw	2 & 6.65 Mc		Ind. or D.	Vac. Tube	11 kva	5 kw	0.45, 5, 15, or 30 Mc		
	Induction	Vac. Tube	—	2.5 kw	2 & 6.65 Mc		Ind. or D.	Vac. Tube	21 kva	10 kw	0.45, 5, 15, or 30 Mc		
	Induction	Vac. Tube	—	5 kw	2 & 6.65 Mc		Ind. or D.	Vac. Tube	43 kva	20 kw	0.45, 2, or 10 Mc		
	Induction	Vac. Tube	—	20 kw	2 & 6.65 Mc		Induction	Vac. Tube	95 kva	50 kw	0.45 Mc		
Illinois Tool Works, 2501 N. Keeler Ave., Chicago 39, Illinois	Induction	Vac. Tube	—	1 kw	—		Induction	Rot. Mach.	—	50 kw	3000 & 9600 cps		
	Induction	Vac. Tube	—	2.5 kw	—		Induction	Rot. Mach.	—	75 kw	9600 cps		
	Induction	Vac. Tube	—	5 kw	—	Induction	Rot. Mach.	—	100 kw	3000 & 9600 cps			
	Induction	Vac. Tube	—	20 kw	—	Induction	Rot. Mach.	—	125 kw	9600 cps			
	Illinois Tool Works, 2501 N. Keeler Ave., Chicago 39, Illinois	Induction	Vac. Tube	—	1 kw	—	Induction	Rot. Mach.	—	150 kw	3000 cps		
		Induction	Vac. Tube	—	2.5 kw	—	Induction	Rot. Mach.	—	200 kw	3000 cps		
		Induction	Vac. Tube	—	5 kw	—	Westinghouse Electric Corp., East Pittsburgh, Pa.	Ind. & Diel.	Vac. Tube	—	1 kw	300 kc & 10 Mc	
		Induction	Vac. Tube	—	20 kw	—		Dielectric	Vac. Tube	6.25 kva	2 kw	5, 15, or 30 Mc	
		Illinois Tool Works, 2501 N. Keeler Ave., Chicago 39, Illinois	Induction	Vac. Tube	—	1 kw		—	Ind. or D.	Vac. Tube	11 kva	5 kw	0.45, 5, 15, or 30 Mc
			Induction	Vac. Tube	—	2.5 kw		—	Ind. or D.	Vac. Tube	21 kva	10 kw	0.45, 5, 15, or 30 Mc
Induction			Vac. Tube	—	5 kw	—		Ind. or D.	Vac. Tube	43 kva	20 kw	0.45, 2, or 10 Mc	
Induction			Vac. Tube	—	20 kw	—		Induction	Vac. Tube	95 kva	50 kw	0.45 Mc	
Illinois Tool Works, 2501 N. Keeler Ave., Chicago 39, Illinois			Induction	Vac. Tube	—	1 kw		—	Induction	Rot. Mach.	—	50 kw	3000 & 9600 cps
			Induction	Vac. Tube	—	2.5 kw		—	Induction	Rot. Mach.	—	75 kw	9600 cps
	Induction		Vac. Tube	—	5 kw	—	Induction	Rot. Mach.	—	100 kw	3000 & 9600 cps		
	Induction		Vac. Tube	—	20 kw	—	Induction	Rot. Mach.	—	125 kw	9600 cps		
	Illinois Tool Works, 2501 N. Keeler Ave., Chicago 39, Illinois		Induction	Vac. Tube	—	1 kw	—	Induction	Rot. Mach.	—	150 kw	3000 cps	
			Induction	Vac. Tube	—	2.5 kw	—	Induction	Rot. Mach.	—	200 kw	3000 cps	
		Induction	Vac. Tube	—	5 kw	—	Westinghouse Electric Corp., East Pittsburgh, Pa.	Ind. & Diel.	Vac. Tube	—	1 kw	300 kc & 10 Mc	
		Induction	Vac. Tube	—	20 kw	—		Dielectric	Vac. Tube	6.25 kva	2 kw	5, 15, or 30 Mc	
		Illinois Tool Works, 2501 N. Keeler Ave., Chicago 39, Illinois	Induction	Vac. Tube	—	1 kw		—	Ind. or D.	Vac. Tube	11 kva	5 kw	0.45, 5, 15, or 30 Mc
			Induction	Vac. Tube	—	2.5 kw		—	Ind. or D.	Vac. Tube	21 kva	10 kw	0.45, 5, 15, or 30 Mc
Induction			Vac. Tube	—	5 kw	—		Ind. or D.	Vac. Tube	43 kva	20 kw	0.45, 2, or 10 Mc	
Induction			Vac. Tube	—	20 kw	—		Induction	Vac. Tube	95 kva	50 kw	0.45 Mc	
Illinois Tool Works, 2501 N. Keeler Ave., Chicago 39, Illinois			Induction	Vac. Tube	—	1 kw		—	Induction	Rot. Mach.	—	50 kw	3000 & 9600 cps
			Induction	Vac. Tube	—	2.5 kw		—	Induction	Rot. Mach.	—	75 kw	9600 cps
	Induction		Vac. Tube	—	5 kw	—	Induction	Rot. Mach.	—	100 kw	3000 & 9600 cps		
	Induction		Vac. Tube	—	20 kw	—	Induction	Rot. Mach.	—	125 kw	9600 cps		
	Illinois Tool Works, 2501 N. Keeler Ave., Chicago 39, Illinois		Induction	Vac. Tube	—	1 kw	—	Induction	Rot. Mach.	—	150 kw	3000 cps	
			Induction	Vac. Tube	—	2.5 kw	—	Induction	Rot. Mach.	—	200 kw	3000 cps	
		Induction	Vac. Tube	—	5 kw	—	Westinghouse Electric Corp., East Pittsburgh, Pa.	Ind. & Diel.	Vac. Tube	—	1 kw	300 kc & 10 Mc	
		Induction	Vac. Tube	—	20 kw	—		Dielectric	Vac. Tube	6.25 kva	2 kw	5, 15, or 30 Mc	
		Illinois Tool Works, 2501 N. Keeler Ave., Chicago 39, Illinois	Induction	Vac. Tube	—	1 kw		—	Ind. or D.	Vac. Tube	11 kva	5 kw	0.45, 5, 15, or 30 Mc
			Induction	Vac. Tube	—	2.5 kw		—	Ind. or D.	Vac. Tube	21 kva	10 kw	0.45, 5, 15, or 30 Mc
Induction			Vac. Tube	—	5 kw	—		Ind. or D.	Vac. Tube	43 kva	20 kw	0.45, 2, or 10 Mc	
Induction			Vac. Tube	—	20 kw	—		Induction	Vac. Tube	95 kva	50 kw	0.45 Mc	
Illinois Tool Works, 2501 N. Keeler Ave., Chicago 39, Illinois			Induction	Vac. Tube	—	1 kw		—	Induction	Rot. Mach.	—	50 kw	3000 & 9600 cps
			Induction	Vac. Tube	—	2.5 kw		—	Induction	Rot. Mach.	—	75 kw	9600 cps
	Induction		Vac. Tube	—	5 kw	—	Induction	Rot. Mach.	—	100 kw	3000 & 9600 cps		
	Induction		Vac. Tube	—	20 kw	—	Induction	Rot. Mach.	—	125 kw	9600 cps		
	Illinois Tool Works, 2501 N. Keeler Ave., Chicago 39, Illinois		Induction	Vac. Tube	—	1 kw	—	Induction	Rot. Mach.	—	150 kw	3000 cps	
			Induction	Vac. Tube	—	2.5 kw	—	Induction	Rot. Mach.	—	200 kw	3000 cps	
		Induction	Vac. Tube	—	5 kw	—	Westinghouse Electric Corp., East Pittsburgh, Pa.	Ind. & Diel.	Vac. Tube	—	1 kw	300 kc & 10 Mc	
		Induction	Vac. Tube	—	20 kw	—		Dielectric	Vac. Tube	6.25 kva	2 kw	5, 15, or 30 Mc	
		Illinois Tool Works, 2501 N. Keeler Ave., Chicago 39, Illinois	Induction	Vac. Tube	—	1 kw		—	Ind. or D.	Vac. Tube	11 kva	5 kw	0.45, 5, 15, or 30 Mc
			Induction	Vac. Tube	—	2.5 kw							

# SURVEY OF

Analysis of causes of drift in direct-current amplifiers, descriptions of methods used to neutralize or prevent drift, and typical industrial applications

By MAURICE ARTZT

RCA Laboratories  
Princeton, N. J.

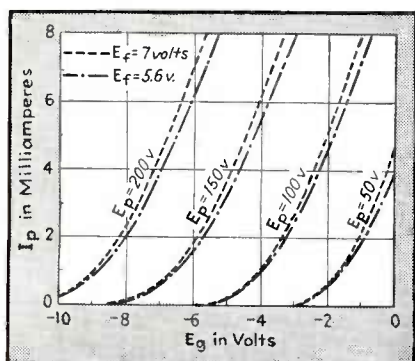

FIG. 1—Effect of filament voltage on characteristics of a 6SN7GT/G tube

**T**HE quest for a stable d-c amplifier is an old one, and will probably continue as long as tube characteristics wander with changes in voltage and temperature. A rapidly expanding literature on the subject gives evidence that considerable progress has been made in overcoming drifts and instabilities usually associated with d-c amplifiers. As their advantages in certain applications become more apparent, still further progress is to be expected.

It was originally intended that this article would be a few brief notes describing a new type of d-c amplifier, but for a number of reasons these original notes have been expanded to include a discussion of the causes of drift, and also a brief description of various methods of either neutralizing or preventing it. The original use of this new amplifier has become of secondary importance in comparison with its adaptation as a cathode-ray deflection amplifier. As square-wave testing and electronic switching techniques are more widely adopted, this and other applications for d-c amplifiers will become increasingly more important. Accordingly, it is felt that a more general survey of d-c amplifiers is justified at this time.

An attempt has been made to provide relatively complete references to literature on the subject. However, it is possible that important references have been omitted because the available material is widely scattered.

## Causes of Drift

There are three primary causes of zero or steady-state drift in the

usual d-c amplifier circuit. The first of these, and the one easiest to eliminate, is drift due to changes in the plate supply voltage. This can be balanced out by either of two methods: by complete regulation of the B supply, or by devising a tube circuit in which the plate current is exactly proportional to the B volt-

age. Where regulation of the B supply is the method chosen it can usually be carried to as high an accuracy as needed, though this results in a rather bulky unit.

The second method is to be preferred wherever possible, for it permits the use of an unregulated voltage supply. It can be readily seen

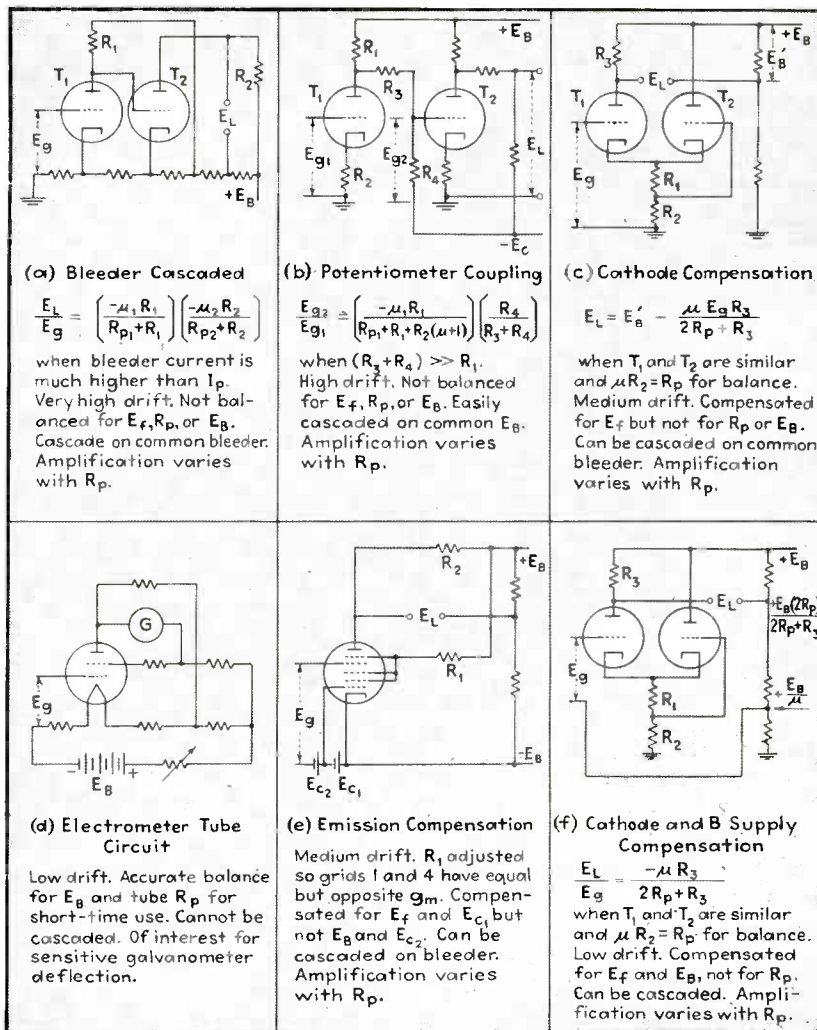

FIG. 2—Fundamental and compensated d-c amplifier circuits

# D-C AMPLIFIERS

that when the plate current of a tube is exactly proportional to the B voltage, then the voltage developed between the plate of this tube and a proper tap on a B supply bleeder will remain zero as the B voltage varies. A bridge balance is thus substituted for an accurately regulated source of plate power.

The other two causes of drift are directly related and result from changes in cathode temperature. The first of these—contact potential—is the most troublesome, and has an effect similar to a change in grid bias as cathode temperature changes. This same change in cathode temperature will also cause the equivalent plate impedance of the

tube to vary. But these two characteristics do not change by a definitely fixed amount with cathode temperature. They both have rather large components interrelated with plate current and plate voltage.

Where the tube is used only in the center of its linear range, and excursions in plate current due to signals are small, then the  $R_p$  of the tube can be considered constant and the effect of these two variables lumped and treated as a shift in grid bias with cathode temperature. Where the operating conditions are not so limited, both must be considered. This is readily seen in the voltage-current equations of a tube.

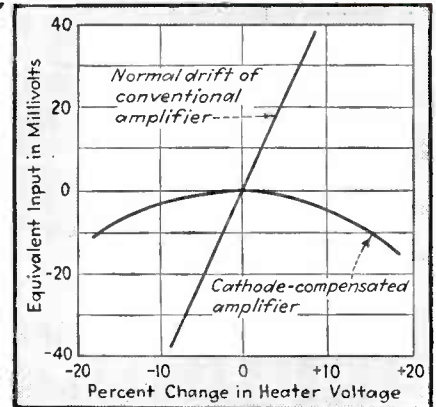

FIG. 3—Characteristic of cathode-compensated d-c amplifier circuit shown in Fig. 2 (c)

It is usual to express the voltage-current equation of a tube as follows

$$i_p = \left[ \frac{E_p + \mu E_g}{R_p} \right]^n \quad (1)$$

For a limited operating range in the linear portion of the tube curves, the exponent  $n$  can be considered to be unity, and  $R_p$  can be considered as the slope of the  $E_p/i_p$  curve at this point. This is usually written then as

$$E_p = i_p R_p - \mu E_g \quad (2)$$

The contact potential drift can then be added as a voltage  $V_f$ , varying with filament voltage, to give the expression

$$E_p = i_p R_p - \mu E_g + \mu V_f \quad (3)$$

This equation can be used over a limited range in deriving the expression for overall performance of an amplifier, and will give a reasonably accurate indication of the drift to be expected as  $V_f$  changes. It is so used in deriving the balance conditions and gain equations for a number of the d-c amplifier systems described later.

That Eq. (3) cannot possibly hold over any large range of voltage variations is shown by the tube curves in Fig. 1. This set of curves was taken on one of the triodes in a 6SN7GT/G tube of average  $g_m$ . The curves are definitely moved to the left in the linear range by an increase in filament voltage, and this gives some weight to the use of the contact potential drift voltage

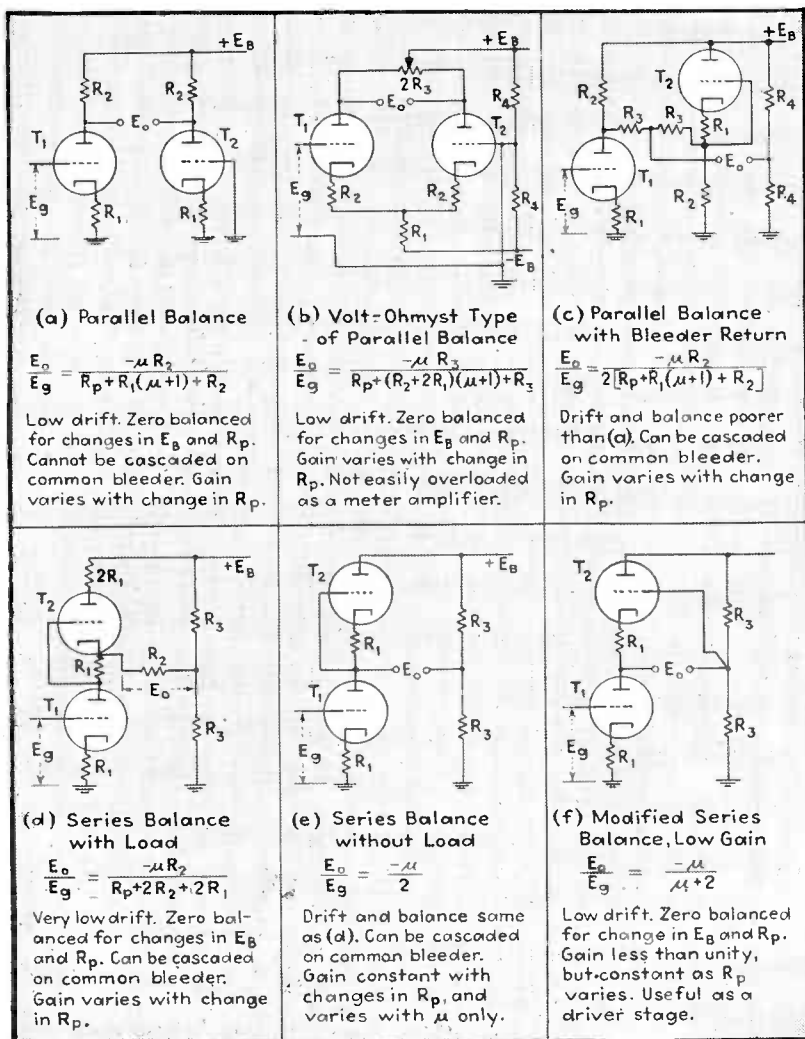

FIG. 4—Fundamental circuits of balanced d-c amplifiers

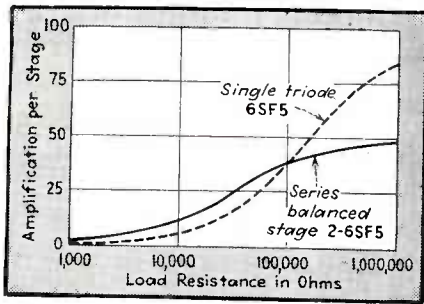

FIG. 5—Variation of amplification with load resistance for a single triode stage and a two-tube series-balanced stage. In both instances no bypass capacitor was used on the cathode bias resistor

$V_f$  assumed in Eq. (3). But account is not taken of the fact that the slope of the curves also changes, for apparently  $R_p$  has decreased as  $E_f$  was increased. What has actually happened in Eq. (1) for this change in filament voltage is that the exponent  $n$  has changed, for the tangent point of intersection of the curves in Fig. 1 has not shifted appreciably. The two sets of curves become more nearly parallel at the higher values of  $I_p$ , so Eq. (3) becomes increasingly more accurate as  $I_p$  increases.

From these tube curves and equations it may be seen that while drifts due to B supply are a first-order effect, those due to cathode temperature are considerably more complicated, and greater care in design is necessary for their elimination.

The four general classifications of d-c amplifiers are (a) simple cascaded amplifiers, (b) modulation systems, (c) compensated d-c amplifiers, and (d) bridge-balanced d-c amplifiers. Each type will be briefly described in turn here.

#### Simple Cascaded Amplifier

In the simple cascaded amplifier, succeeding stages are usually stepped up a B supply bleeder, or coupled with a potentiometer divider with consequent loss in gain. These are illustrated in Fig. 2(a) and 2(b) and, supplied with unregulated voltages, are notorious for drift. They are seldom used without some form of correcting or compensating system.

One form of drift control can be obtained by adding 100-percent degenerative feedback to obtain a current amplifier with unity voltage gain. This circuit is so applied

in a commercial sensitive microammeter.<sup>1</sup>

The circuit in Fig. 2(b) has been used in various ways with feedback<sup>2</sup> and with correction for the loss in voltage gain,<sup>3, 4</sup> but in either case careful regulation of plate and filament supplies is required to eliminate drift.

#### Modulation Systems

While modulation systems are not strictly d-c amplifiers, they are so used in many applications and have considerable merit. In this type the d-c signal to be amplified modulates a carrier wave, and after sufficient amplification the wave is detected to obtain the amplified signal. Such systems are well known and the literature is fairly complete.<sup>5, 6, 7</sup>

Where the required frequency response is very high, these systems become awkward because the high carrier frequency requires elaborate shielding. It is therefore

more limited in its applications than the two types that follow.

In a modified form, the input signal itself is chopped. This can be done by a light shutter for phototube amplifiers, or by vibrators or tubes for other types of signals.<sup>8</sup>

In compensated d-c amplifiers some variable characteristic of the amplifying tube is balanced against the same variations in another tube, or against a different characteristic of the same tube. This system compensates for contact potential drift in the cathode-coupled amplifier system, as illustrated in Fig. 2(c).<sup>9, 10, 11, 12, 13</sup> When used with an accurately regulated power source a stable system results.

#### Compensated D-C Amplifiers

This cathode-compensated amplifier can be considerably improved and still greater freedom from drift obtained if the input voltage includes a tap on the B supply bleeder at the value of  $E_b/\mu$ , as shown in

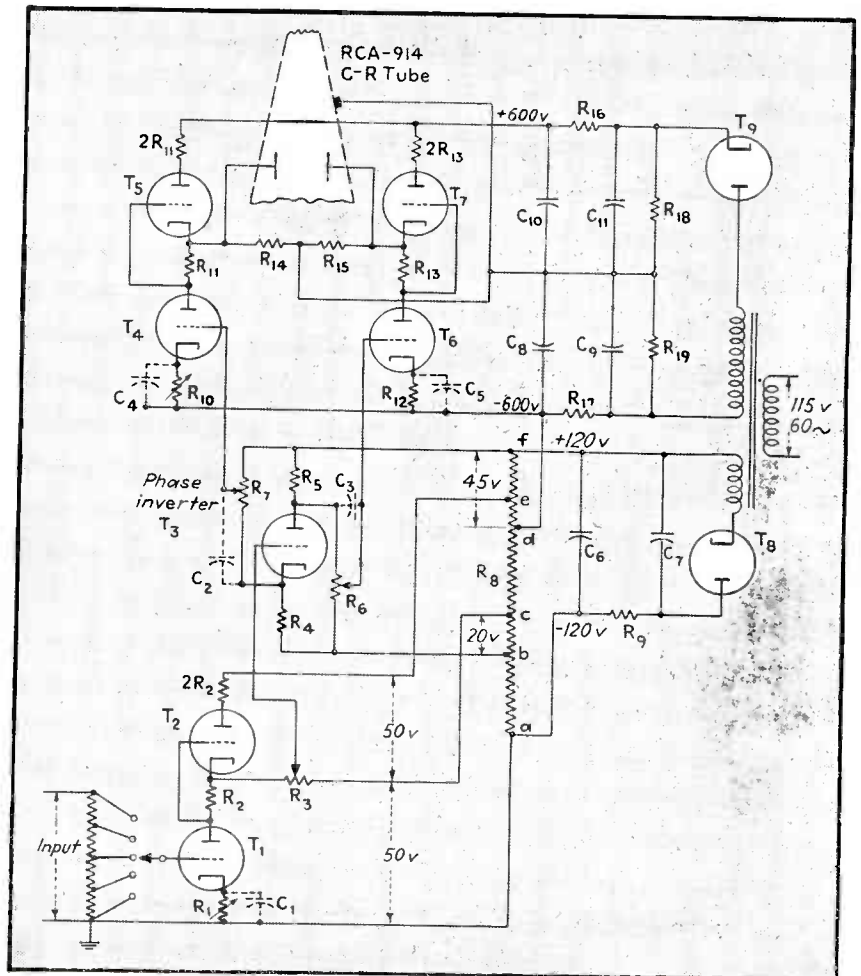

FIG. 6—Series-balanced d-c amplifier circuit arranged for feeding a pair of deflecting electrodes in a cathode-ray tube of an oscilloscope

Fig. 2(f). This addition makes the zero-signal output current directly proportional to plate voltage. When the output is then returned to the proper point on the bleeder, the effect of changing  $E_B$  is eliminated, and the plate supply need not be regulated.

The drift characteristic of amplifiers of this type as compared to a conventional amplifier is shown in Fig. 3. The balance obtained is a tangential one, and holds over only a limited range of filament supply variation. For this reason, even with  $E_B$  compensation as in Fig. 2(f), only a limited supply voltage change can be allowed if resetting of the zero point is to be avoided.

By a fortunate choice of constants this compensation for filament and plate voltage can be obtained in the amplifying tube itself, as in the electrometer tube circuits.<sup>14, 15</sup> One form of this circuit is shown in Fig. 2(d). As this circuit cannot be readily cascaded, it is chiefly of interest for use with a sensitive galvanometer.

Compensation for changes in emission, whether due to heater voltage change or to a random effect, can be obtained in a pentagrid type of tube as shown in Fig. 2(e)<sup>16</sup>. Here the value of  $R_1$  is adjusted to make grids 1 and 4 have equal but opposite transconductance to the plate, and the compensation therefore includes all circuit elements common to both grids, but does not include the plate supply. In this circuit, as in the cathode-compensated circuits, with the two control grids having equal but opposite effects on the plate current, signals can be applied to either grid, or to both at the same time to obtain a differential amplifier. If grid 4 in Fig. 2(e) is returned to a tap on a bleeder across the plate supply, correction for changes in  $E_B$  will be obtained in a manner similar to that applied to the circuit in Fig. 2(f).

While this brief resume of compensating systems is not complete, it includes the better known methods and will serve to illustrate how compensation for filament supply can be obtained, and show that compensation for plate supply can usually be added for increased stability.

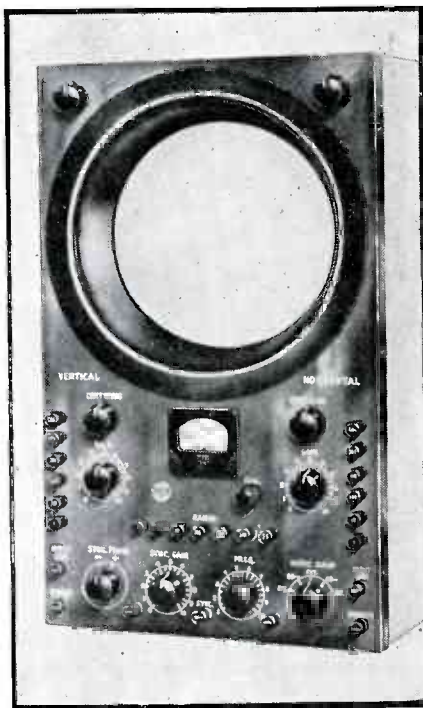

FIG. 7—RCA 327A oscilloscope, which uses a series-balanced d-c amplifier circuit

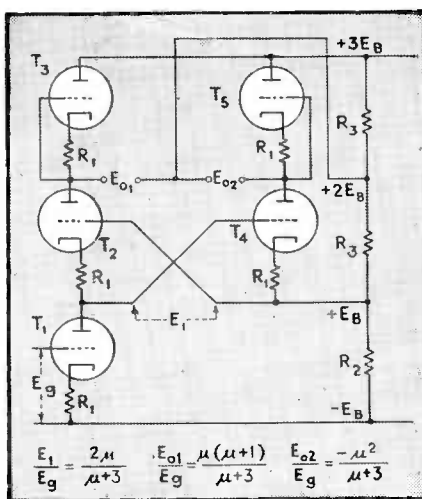

FIG. 8—Circuit illustrating use of the modified series-balanced low-gain driver stage of Fig. 4 (f) to obtain push-pull output from single-ended input

A distinction is made between compensated and bridge-balanced d-c amplifiers, for in bridge-balanced circuits all variables in the amplifying arm, including tube characteristics and supply voltages, are balanced against similar variables in a second arm of the bridge. Thus if the parameters of the non-amplifying arm vary in the same manner as those in the amplifying arm, a complete balance for  $E_f$ ,  $E_B$ ,  $R_p$ , and contact potential is obtained. While it may be argued that no two tubes will balance for all of these

changes, it has been found experimentally that such a balance is no more difficult to obtain than the balance for contact potential alone as used in the compensated circuits.

### Bridge-Balanced D-C Amplifiers

The advantages of this type of balance are that regulation of plate and filament supplies becomes unnecessary except where extreme precision is required, and the balance holds for any part of the tube curves. Operation becomes less critical and more consistent.

The conventional type of balanced d-c amplifier is shown in Fig. 4(a). It is the equivalent of returning the output voltage to a bleeder in which the bleeder proportioning changes in the same manner as the amplifying tube. This type of amplifier will balance perfectly if the two tubes remain identical in characteristics as supply voltages change. It is often used in tube voltmeter circuits.<sup>17</sup>

A modification of this circuit, in Fig. 4(b), is found in the well-known Volt-Ohmyst circuit for voltage and resistance measurements.<sup>18</sup> While having some of the features of the cathode-coupled circuits, the main balance is still between the two tubes in parallel, with the common coupling resistor  $R_1$  assisting in maintaining a constant zero position.

Neither of these two circuits can be cascaded as shown, and both are most useful as meter amplifiers, etc. Where higher gain is required than one stage will give, the circuit in Fig. 4(a) can be modified to that in Fig. 4(c) to allow cascading. The output then is returned to the B supply bleeder and additional stages can be stepped up the bleeder in the usual manner. In this case the gain per stage has been cut in half from that of the circuit in Fig. 4(a), and the high-frequency response has been impaired by the high value of series resistors  $R_3$  that feed the output. For proper balance the circuit requires that four pairs of resistors as well as the tubes remain constant and it will therefore have slightly more drift than the circuit of Fig. 4(c) under similar conditions.

These disadvantages in Fig. 4(c)

can be eliminated and several important advantages gained by shifting  $T_2$  and its cathode resistor over to replace the plate resistor for  $T_1$  as shown in Fig. 4(d) and 4(e).<sup>19</sup> Here the balance is no longer for tubes in parallel, but rather in series, and both pass the same plate current at the zero-signal position. The balance for changes in  $E_n$  and  $R_n$  is more nearly perfect than in Fig. 4(a), 4(b), and 4(c). A differential change in contact potential between the two tubes will shift the zero position as in any other balanced arrangement, but with the same plate current in each tube this effect is much less pronounced than in the parallel systems.

If the value of load resistor  $R_3$  is low, somewhat higher amplification will be obtained with the circuit in Fig. 4(d) than with the simplified version in Fig. 4(e). In Fig. 4(d) the load current flows through the cathode resistor of  $T_2$  in a regenerative direction. However, for all practical purposes, if a load resistor equal to or greater than the  $R_p$  of the tubes is used, there is little difference and the simpler arrangement of Fig. 4(e) with its fewer parts is preferred.

In both Fig. 4(d) and 4(e) the cathode resistor of  $T_1$  is usually made variable as a balance adjustment. The range of adjustment is purposely made small,  $\pm 15$  percent from the value of the cathode resistor of the upper tube. Under these conditions it has been found that if  $R_1$  can be set within this range so that  $E_0 = 0$  with no input to the grid of  $T_1$ , the two tubes are sufficiently well matched for all practical purposes, and hold this balance over very wide changes of filament and plate voltages. When properly balanced in this manner a sensitive voltmeter can be connected across  $E_0$  and will show no deflection even when the line voltage supplying filament and plate power is switched off and on.

A third arrangement of the series-balanced system is shown in Fig. 4(f). Here the upper grid is returned to the bleeder instead of to the plate of  $T_1$ , and the voltage gain is reduced to slightly less than unity. This is useful as a current amplifier for meters, or as a driver

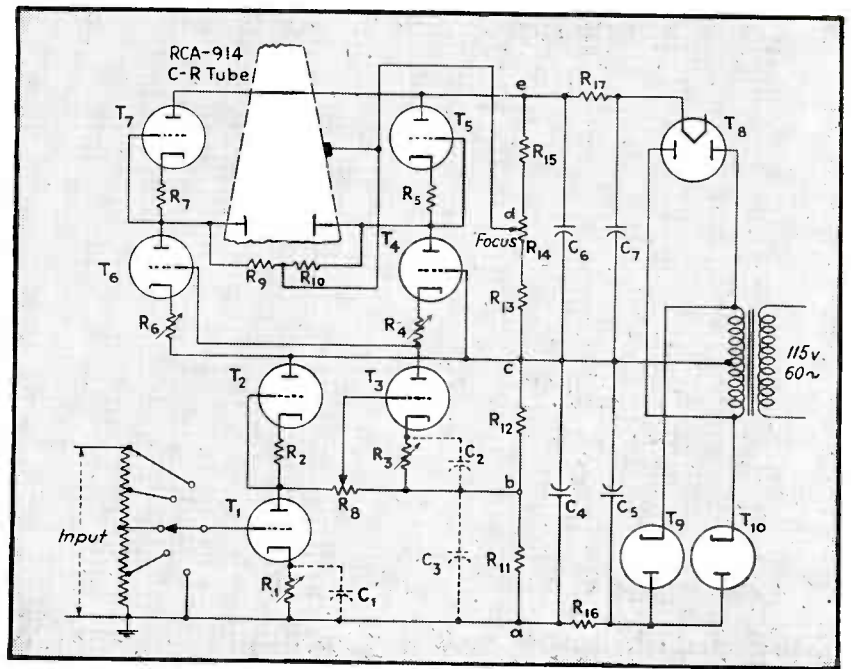

FIG. 9—Alternative method of using a series-balanced d-c amplifier for oscilloscope deflection

stage for a succeeding cascaded push-pull arrangement discussed later. Its drift is slightly more than the true series systems of Fig. 4(d) and 4(e), but is still very low.

In Fig. 5 a comparison is given between the voltage gain of a series-balanced stage and of a single tube used in the usual manner. The tubes were 6F5 in both cases, with 1000-ohm self-biasing cathode resistors, not bypassed. For low values of load resistance the balanced stage will give higher gain, but for high-resistance loads the single tube has the greater amplification. The upper limit of gain for the balanced stage is  $\mu/2$ , or 50 in this case, and it reaches very nearly this value with loads three or more times the plate resistance.

#### Oscilloscope Deflection Amplifiers

Two types of deflection amplifiers have been built using the basic series-balanced amplifier circuits shown in Fig. 4(d), 4(e), and 4(f). The first of these is shown in Fig. 6 and is used with minor modifications in the RCA-327A Oscilloscope shown in Fig. 7.

The output stage consists of four 6SF5 tubes in push-pull balance and supplied from a 600-volt power supply, non-regulated and only half-wave rectified. This stage is driven from  $T_3$ , a 6J5 used as a

phase inverter. The inverter stage obtains its plate power from the bleeder on a second d-c source of 120 volts, again unregulated and half-wave rectified. The input stage, employing 6SF5 tubes for  $T_1$  and  $T_2$ , draws plate power from the same low-voltage bleeder that feeds the phase inverter. This bleeder is 10,000 ohms and has fixed taps providing the voltages shown. No bypassing is used between any taps on the bleeder. This prevents any one section from having a different time delay on build-up or decay with a changing line voltage. Half-wave rectifying for the two power supplies is possible because all hum is balanced out for the zero-signal condition, and rises to only a few percent when sweeping a nine-inch screen.

The process of balancing the amplifier is simple, and the cathode-ray tube itself is used as the indicator. The two load resistors,  $R_{14}$  and  $R_{15}$ , are shorted, and the zero position of the cathode-ray spot is marked. The grid of  $T_1$  is then shorted to minus 600 volts and the short on  $R_{14}$  removed.  $R_{10}$  is adjusted to bring the spot back to its zero position. Then the grid of  $T_6$  is shorted to minus 600 volts, the short on  $R_{15}$  removed, and  $R_{12}$  adjusted to recenter the spot.

The output stage is now balanced and the phase inverter can be ad-



justed. Short  $R_3$  so the inverter has zero input, remove the short between the grid of  $T_1$  and minus 600 volts, and adjust  $R_7$  to center the spot, then remove the short on the grid of  $T_2$  and adjust  $R_6$  to again center the spot. Now with the input control at zero, the short across  $R_3$  can be removed and  $R_1$  finally adjusted to center the spot again. The entire amplifier is now balanced and ready for use.

The amplifier as described will have a flat response from pure direct current to over 20,000 cycles. By the addition of the five capacitors shown in dotted lines, the upper limit is raised to over 100,000 cycles. The values of these are determined by the circuit constants and the various capacitances to ground.

In use this amplifier shows remarkable stability of image, there being no breathing with widely changing line voltages, and no capacitance couplings to cause transients that jump the image off the screen on change of input. Turning off the power and later turning it on causes the image to fade out and then fade in without appreciably changing location on the screen.

It has been found that with the oscilloscope in daily use for many hours at a time any readjustment of balance was unnecessary for periods of six months or more, and the spot position over this time and from cold to hot never varied over 0.1 inch. As the deflection sensitivity is approximately 0.1 volt per inch, this shows an overall long-time drift of not over 10 millivolts as referred to the input. When it is considered that ordinary tubes and resistors are used and that neither plate nor filament supplies are regulated, this performance becomes remarkable.

#### Push-Pull Driver for Oscilloscope

A second type of deflection amplifier was built with the stage shown in Fig. 4(f) as a push-pull driver. The method of obtaining push-pull from this driver is shown in detail in Fig. 8. Here the driver tube  $T_1$  passes the full plate current of that side of the output having tubes  $T_2$  and  $T_3$  in series. As the grid of  $T_2$  is connected to the B supply bleeder, it forms a

cathode drive for  $T_2$ . At the same time the second half of the output stage has the lower cathode returned to the bleeder and the lower grid is driven by  $T_1$ . Thus  $T_2$  and  $T_3$  are driven in opposite phase to obtain push-pull output. While the balance of zero position is correct with this type of drive, the two output voltages  $E_{o1}$  and  $E_{o2}$  are not quite the same, but differ by the ratio of  $(\mu + 1)/\mu$ . However, this is not serious, as it amounts to only three percent with 6SH7 tubes as triodes in the output stage. This is as close to a true balanced push-pull as is ordinarily obtained in any circuit unless the tubes are especially picked.

The complete deflection amplifier

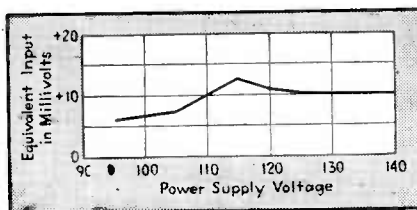

FIG. 10—Effect of variations in power supply voltage on drift in the oscilloscope deflection amplifier of Fig. 9

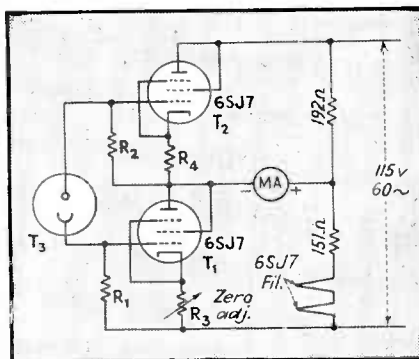

FIG. 11—Series-balanced amplifier used as a light meter

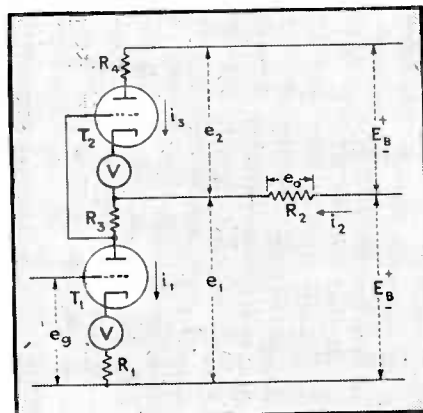

FIG. 12—Derivation of series-balanced conditions in an amplifier

with this drive system is shown in Fig. 9. This second system has the advantage over the first that the two plate power sources are connected plus to minus rather than at an intermediate point as in Fig. 6. Thus both upper and lower supplies can be obtained from a single power transformer winding. In addition the driver stage has nearly unity gain, rather than a 2 to 1 loss as in the phase inverter, so additional sensitivity can be obtained.

This amplifier was built with 6SJ7 tubes for  $T_1$  and  $T_2$  and 6SH7 tubes for  $T_3$ ,  $T_4$ ,  $T_5$ ,  $T_6$ , and  $T_7$ . All were connected as triodes with suppressor and shell connected to cathode, and screen to plate. The four bleeder voltages  $ab$ ,  $bc$ ,  $cd$ , and  $de$  are equal, and in this case 300 volts each. The three capacitors shown dotted bring the flat response up to 250,000 cycles, with a slow drop-off above this. The amplifier is usable at 500,000 cycles with about fifty percent of the deflection at zero frequency or direct current.

#### Comparison of Oscilloscope Circuits

The balance conditions obtained with the circuit of Fig. 9 are not quite as good as in the first method because tube  $T_3$  must balance through  $T_6$  and  $T_7$  in series, but the spot is still within 0.2 inch of its cold position after an eight-hour run. The deflection sensitivity is less than for Fig. 6, as tubes with a lower  $\mu$  are used to get better high-frequency response.

One precaution is necessary here that was unnecessary with the first amplifier; namely, adjustment of the time constants of the two power supplies to be equal and thus prevent breathing with line voltage changes. As upper bleeder  $cde$  has the heavier tube load across it, the overall value of  $R_{11}$  and  $R_{12}$  must be somewhat less than the sum of  $R_{13}$ ,  $R_{14}$ , and  $R_{15}$ . The value is easily determined by using a Variac in the supply line, and adding additional load from  $a$  to  $c$  until breathing is eliminated with sudden line changes. Once determined, a fixed load can be put across  $a$  to  $c$ , as this is not critical and need not be made variable for future adjustments.

The drift performance of this amplifier with changes in line voltage is shown in Fig. 10, where the

equivalent input in millivolts is plotted against the power line voltage. Between the line voltage limits of 105 to 140 volts this drift is only  $\pm 2.5$  millivolts, and represents a spot movement of  $\pm 0.008$  inch on the nine-inch screen. This is considerably better than is obtained with most a-c deflection amplifiers even with carefully regulated plate supplies.

Both of these deflection amplifiers are shown without the usual centering control. The resistor  $R_1$  is used for centering in either case by throwing the amplifier off balance the required amount to move the zero position of the spot anywhere on the screen. This is an instantaneous movement and does not have the high time delay of motion obtained with the centering control on an a-c deflection amplifier.

In both amplifiers the second anode of the cathode-ray tube is above ground, by 375 volts in Fig. 6 and by 900 volts in Fig. 9. This voltage, therefore, adds to the usual high negative voltage supplying the cathode of the cathode-ray tube to give the total cathode-to-anode accelerating voltage. The reason for not grounding the second anode is, of course, to allow one side of the signal input to be grounded.

#### Photoelectric Light Meter

One interesting application of the series-balanced circuit should be noted. This is a light meter that can be calibrated as an exposure meter or the like. The circuit in Fig. 11 is almost self-explanatory, for the two tubes are operated as in the other circuits described, but with a-c plate supply. The phototube is connected grid to grid to obtain additional amplification. The two grid resistors are equal and one megohm each, and the meter is one milliamper full scale.  $R_1$  is 500 ohms and  $R_3$  is 400 ohms fixed and 200 ohms variable.

With this arrangement and with an RCA 918 phototube, a full-scale deflection can be obtained with 0.1 lumen through a  $\frac{3}{8}$ -inch diameter aperture. Other scales can be provided by switching meter shunts, grid resistors, or apertures. As no transformers or rectifiers are used, a compact instrument results.

#### Sample Algebraic Treatment

The algebraic derivation of the relationship of output to input voltages in the circuits shown is simple when Eq. (3) is used to represent tube performance. As an example, the formula for the series-balanced amplifier in Fig. 4(d) can be developed as follows:

Consider the circuit as shown in Fig. 12 with the contact potential drift of each tube inserted as the voltage  $v$  in each cathode lead. It is assumed for both tubes  $T_1$  and  $T_2$  that these two voltages  $v$ , as well as the tube constants  $\mu$  and  $R_p$ , are equal for the balanced condition.

Under these conditions the voltage across the tube  $T_1$  will be, according to Eq. (3)

$$e_{p1} = i_1 R_p - \mu[e_0 - v - i_1 R_1] \quad (4)$$

$$\text{Then } e_1 = e_{p1} + i_1 R_1 + i_1 R_3 + v \\ = i_1 [R_p + \mu R_1 + R_1 + R_3] + v[\mu + 1] - \mu e_0 \quad (5)$$

$$\text{But } i_1 = i_2 + i_3 \quad (6)$$

$$\text{and } E_B = e_1 + i_2 R_2 \quad (7)$$

Combining Eq. (5), (6), and (7) and solving for  $i_3$

$$i_3 = \frac{E_B - v(\mu + 1) + \mu e_0}{R_p + \mu R_1 + R_1 + R_3} \quad (8)$$

Now, also by Eq. (3), the voltage across  $T_2$  is

$$e_{p2} = i_3 R_p - \mu[0 - i_3 R_3 - v] \quad (9)$$

Substituting for  $i_1$  its value from Eq. (6)

$$e_{p2} = i_3 [R_p + \mu R_3] + i_2 \mu R_3 + v[\mu + 1] \quad (10)$$

$$\text{Now } e_2 = e_{p2} + v + i_3 R_4 \quad (11)$$

$$\text{and } E_B = e_2 - i_2 R_2 \quad (12)$$

Combining Eq. (10), (11), and (12) and solving for  $i_3$

$$i_3 = \frac{E_B - v(\mu + 1) - i_2 [\mu R_3 - R_2]}{R_p + \mu R_3 + R_4} \quad (13)$$

Now Eq. (8) and (13) can be set equal to each other to solve for  $i_2$ , but it can also be seen that both  $E_B$  and  $v$  will cancel out of the expression for  $i_2$  if the two denominators are equal. For this to be true

$$\mu R_3 + R_4 = \mu R_1 + R_1 + R_3 \quad (14)$$

and the simplest method of making Eq. (14) true is with

$$R_3 = R_1 \text{ and } R_4 = 2R_1 \quad (15)$$

Under these conditions, combining Eq. (8) and (13) gives

$$i_2 = \frac{\mu e_0}{R_p + 2R_1 + 2R_2} \quad (16)$$

and the voltage  $e_0$  must therefore be

$$e_0 = \frac{\mu e_0 R_2}{R_p + 2R_1 + 2R_2} \quad (17)$$

The circuit now balances so that the output voltage  $e_0$  is directly proportional to  $e_0$ , and is not affected by contact potential  $v$  or plate supply voltage  $2E_B$  (as long as  $e_0$  returns to the center of the B supply).

One interesting thing brought out in Eq. (13) is that when the load resistor  $R_2$  has the critical value of  $R_2 = \mu R_1$ , the current  $i_3$  through  $T_2$  does not change with signal, but holds a constant value, and only  $i_1$  and  $i_2$  change with signal.

When the load resistor  $R_2$  becomes infinite, Eq. (17) reduces to the simplest form and has the highest gain

$$e_0 = \mu e_0 / 2 \quad (18)$$

This same simple algebraic treatment has been used to derive the expressions given under the circuits shown in Figs. 2, 4 and 8.

#### REFERENCES

- (1) RCA ultra-sensitive d-c meter No. 9819.
- (2) Brubaker, W. M., D-C Amplifier, *Bulletin of the American Physical Society*, Vol. 14, No. 6, Dec. 7, 1939.
- (3) Mezger, G. Robert, Feedback Amplifier for C-R Oscilloscopes, *ELECTRONICS*, p. 126-131 and 254, Apr. 1944.
- (4) Mezger, G. Robert, A Stable Direct-Coupled Amplifier, *ELECTRONICS*, p. 106-110 and 352-353, July 1944.
- (5) Balanced Modulator, U. S. patent 1,988,472, Jan. 1935.
- (6) Whitaker and Artzt, Development of Facsimile Scanning Heads, "Radio Facsimile," RCA Institutes Technical Press, published Oct. 1938.
- (7) Black and Scott, A D-C Amplifier, *Proc. I.R.E.*, June 1940.
- (8) Vacuum-Tube Chopper, U. S. patent 2,323,966, July 1943.
- (9) Miller, S. E., Sensitive D-C Amplifier with A-C Operation, *ELECTRONICS*, p. 27-31 and 105-109, Nov. 1941.
- (10) Williams, Emerys, The Cathode-Coupled Double-Triode Stage, *Electronic Engineering*, London, Vol. XVI, No. 195, p. 509-511, May 1944.
- (11) Ginzton, E. L., D-C Amplifier Design Technique, *ELECTRONICS*, Mar. 1944.
- (12) Goldberg, A High-Gain D-C Amplifier for Bioelectric Recording, *Electrical Engineering*, Vol. 59, p. 60-64, Jan. 1940. This circuit has some of the features of the cathode-balanced circuits in combination with a push-pull balance. A high cathode resistor is used to obtain push-pull from a single-ended input. This resistor was later replaced by a pentode to get the effect of an infinite cathode resistance without excessive voltage drop.
- (13) Richter, Walter, Cathode Follower Circuits, *ELECTRONICS*, p. 112-117 and 312, Nov. 1943.
- (14) Penick, D. B., Direct-Current Amplifier Circuits for Use with the Electrometer Tube, *Review of Scientific Instruments*, p. 115-120, Apr. 1935.
- (15) Huntoon, R. D., An Inexpensive Direct-Current Amplifier, *Review of Scientific Instruments*, p. 322-326, Oct. 1935.
- (16) Bousquet, A. G., Random Emission Compensation, *General Radio Experimenter*, May 1944.
- (17) Thurston, J. N., An A-C Operated Vacuum-Tube Voltmeter, *ELECTRONICS*, p. 102-104 and 224-232, Oct. 1943.
- (18) RCA Volt-Ohmyst, No. 165A.
- (19) Series-Balanced Amplifier, U. S. patent 2,310,342, Feb. 1943.

Typical inductor iron-core shapes. In the upper right corner is a Hipsersil loop; the others, recognizable from their shapes, are E-E, M, E-I, F and L laminations

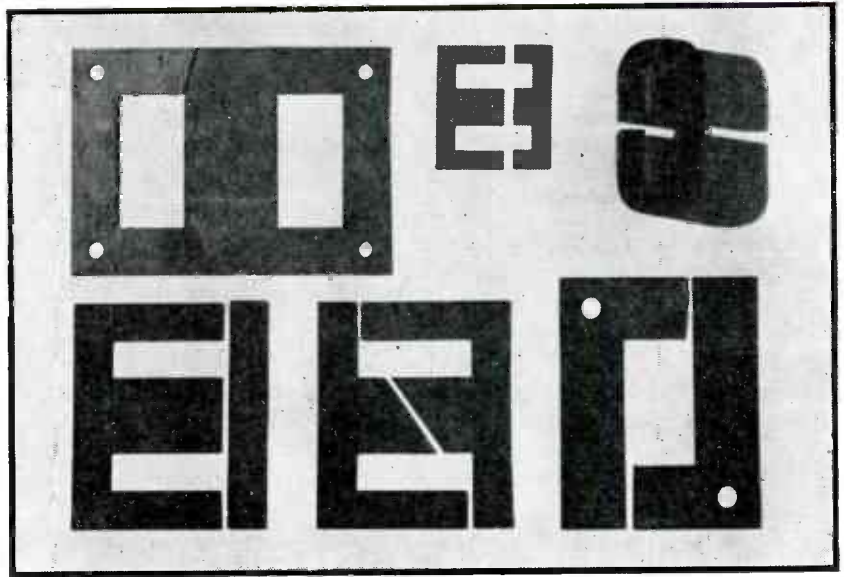

# High-Q Iron-Cored Inductor Calculations

From analytic development, equations for the conditions at which inductor  $Q$  will be at its highest are derived. Using these equations, core and coil dimensions for an iron-cored inductor are calculated and the effects of varying its parameters are studied

**I**RON-CORED audio-frequency inductors of good  $Q$  can be designed with reasonable accuracy, and their performances over a range of frequency and voltage can be predicted by the method to be described herein. Intuition regarding these matters develops with experience, and model theory may be applied, nevertheless it is desirable to approach the subject from an analytical point of view.

Literature is replete with general information on the subject but there does not seem to be a completely organized method of solution. It is the object of this paper, therefore, to present a "cook-book" method for inductor design aimed at obtaining a design that will give an optimum value of  $Q$ .

The approach is to write down

By **STEPHEN L. JAVNA**

*Chief Engineer  
Magnetic Devices Company  
New York, N. Y.*

all pertinent equations, making a few simplifying assumptions so that all the variables that enter into them will be analytic. These equations are substituted, one into another, and the result then differentiated and equated to zero in such a manner as to obtain the optimum design conditions. Thus, although the final design equations are suitable for blind substitution of the given coil parameters and direct solution for the remaining parameters, they will be based on mathematical development.

Design equations for direct substitution simplify such design problems as determining the manner in

which each coil dimension affects the coil  $Q$ , and thus aid in determining the changes in design that will lead to the required inductor improvements.

The utility of the equations has been tested in design by comparing the calculated with the measured characteristics.

The development will be directed toward finding an answer to the following problem.

Given: Required inductance  
Maximum allowable coil dimensions  
Operating voltage  
Operating frequency  
No d-c in the coil

To find, for a condition of optimum  $Q$ :

Number of turns  
Wire size

Lamination size and stack  
Lamination material  
 $Q$   
Effect of parameters on  
 $Q$  and inductance

### Inductor Construction

Generally speaking, inductors used in communication equipment such as wave filters include a coil of wire that is wound over a suitable form in a manner described elsewhere.<sup>1</sup> The coil is mounted over an iron core which among other forms may comprise a toroidal dust core, Hipersil loop, conventional E-I laminations, or any one of the innumerable other lamination forms and shapes, none of which affects the design procedure.

A popular and easily available shape is the scrapless E-I lamination. These are so called because two Es and two Is are stamped simultaneously from a single blank as shown in Fig. 1(a), with no scrap. Fig. 1(b) gives the dimensions of a choke coil utilizing scrapless laminations of such a quantity as to provide a square cross-sectional area of magnetic path. These laminations are described in greater detail in manufacturers' handbooks.<sup>2</sup>

A magnetic path of square cross-section is desirable because it can be shown that for a given cross-sectional area of magnetic path, the rectangular configuration which gives the shortest mean length per turn of wire is a square. Due to burrs and scale on the laminations, the effective or net cross-sectional area of the stack and tongue width is about 0.9 of this product.

Laminations may be stacked by interleaving, or by stacking all the E pieces in the same direction, and butting the I pieces against them as shown in Fig. 1(b). If an air gap is required, a nonmetallic gap spacer of proper thickness is inserted in the joint between each E and I, and the assembly mechanically clamped together. The coil is always designed to fill the window of the closed lamination, as Fig. 1(c) indicates.

### Development of Design Equations

At a given set of conditions of frequency and voltage the equivalent circuit of an iron-cored inductor may be represented by Fig. (2).  $R_{a-c}$  is a fictitious value of resistance which, if multiplied by the square of the coil current, will give the core loss of the inductor. Thus, the losses in the inductor may be represented by  $I^2R_{d-c} + I^2R_{a-c}$ , where  $I^2R_{d-c}$  includes copper losses, and  $I^2R_{a-c}$  includes core losses.

In developing design equations, we will first derive expressions for the alternating-current and direct-current resistances of the inductor. By combining these two resistance equations with the equation for the  $Q$  of the inductor, we will obtain the design equations.

To determine the alternating-current resistance let us assume that core loss of an inductor can be expressed in the form

$$P_{c1} = kB^aw \text{ watts per pound} \quad (1)$$

Quantities represented by symbols used in this and subsequent equations are given in Table I. Total core loss in the inductor is then

$$P = kB^aw \text{ watts} \quad (2)$$

But by Ohm's law, core loss is also given by

$$P = I^2R_{a-c} \text{ watts} \quad (3)$$

Equating Eq. (2) and (3) and solving for  $R_{a-c}$ , we obtain

$$R_{a-c} = kB^aw/I^2 \text{ ohms} \quad (4)$$

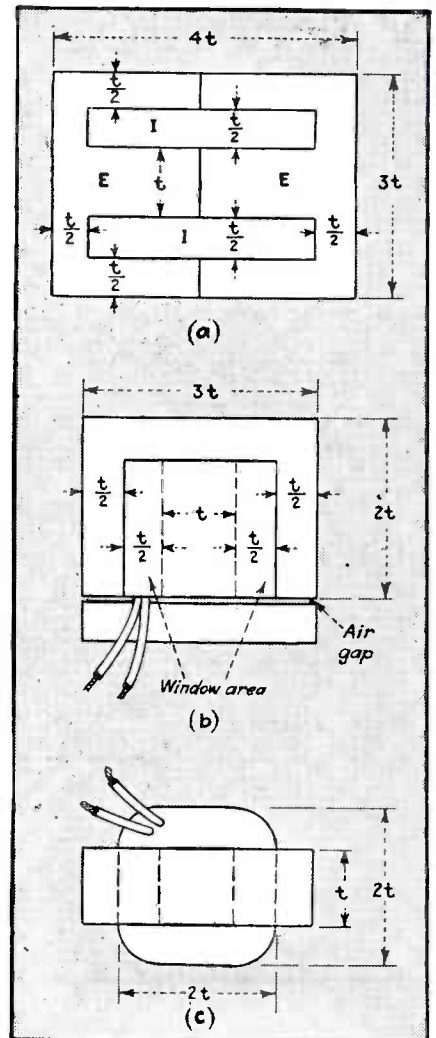

FIG. 1—(a) Layout for stamping scrapless E-I laminations. (b) Plan view assembly of core from laminations. (c) Elevation of completed transformer, showing coil wound on core

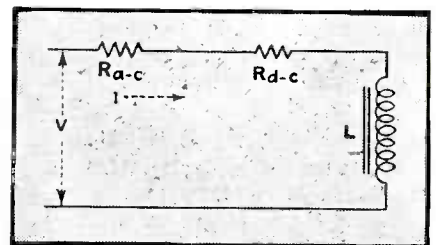

FIG. 2—Equivalent circuit of iron-cored inductor at a fixed frequency and voltage

Since the  $Q$  of the coil will usually be greater than 10, practically no error is introduced by setting

$$I = V/2\pi fL \text{ amperes} \quad (5)$$

Substituting Eq. (5) in Eq. (4) and solving, we obtain

$$R_{a-c} = 39.5kB^aw(fL/V)^2 \text{ ohms} \quad (6)$$

Table I.—Symbols for coil and core parameters used in the text

$A$	— Effective cross-sectional area of magnetic flux path, in square inches
$A_p$	— Gross cross-sectional area of magnetic path, in square inches
$a$	— Empirical constant, see Eq. (1)
$B$	— Maximum flux density within the core, in maxwells per square inch
$C$	— Area of coil conductor, in square inches
$F$	— Fraction of core-window area occupied by copper wire of coil
$f$	— Frequency, in cycles per second
$g$	— Actual gap length, in inches
$I$	— Current through coil, in amperes
$k$	— Empirical constant, see Eq. (1)
$L$	— Inductance of iron-cored coil, in henrys
$l$	— Mean length of magnetic path, in inches
$L'$	— Length of coil conductor, in inches
$m$	— Mean length of a turn of the coil, in inches
$\mu\Delta$	— Incremental permeability of core with respect to air at operating frequency, in gilberts per inch
$N$	— Number of turns in coil
$n$	— B&S wire size number of conductor
$R_{a-c}$	— Apparent alternating-current coil resistance caused by core loss, in ohms
$R_{d-c}$	— Copper-loss resistance, in ohms
$R'$	— Reluctance of air gap assuming no fringing, in gilberts per maxwell
$\rho$	— Resistivity of conductor, on ohm-inches ( $0.6788 \times 10^{-6}$ for copper)
$s$	— Total lamination window area, in square inches
$t$	— Tongue width, in inches, see Fig. 1(a)
$V$	— Voltage across coil, in volts
$w$	— Weight of core, in pounds

Direct-current resistance of any conductor can be represented by the equation

$$R_{d-c} = \rho L'/c \text{ ohms} \quad (7)$$

Where  $L'$  can be found from

$$L' = mN \text{ inches} \quad (8)$$

For any coil the conductor cross-sectional area can be computed from the winding window area by  $c = sF/N$  square inches (9)

Substituting Eq. (8) and (9) into Eq. (7) and solving for the direct-current coil resistance we find that

$$R_{d-c} = (mN^2/sF)0.6788 \times 10^{-6} \text{ ohms} \quad (10)$$

The basic equation for induced emf in a coil is  $V = 4.44fNBA \times 10^{-8}$  volts, or

$$N = (V/4.44fBA)10^8 \text{ turns} \quad (11)$$

Substituting Eq. (11) into Eq. (10) we obtain

$$R_{d-c} = (m/sF)(V/fBA)^2 \times 3.44 \times 10^8 \text{ ohms} \quad (12)$$

Equations (6) and (12) give us the alternating-current and direct-current resistances of the inductor in terms of primary design parameters.

Inductor design is to be such that the  $Q$  will be as high as possible.  $Q$  is given by the definition

$$Q = 2\pi fL/(R_{a-c} + R_{d-c}) \quad (13)$$

It is apparent that  $Q$  will be a maximum when  $(R_{a-c} + R_{d-c})$  is a minimum. Differentiating  $(R_{a-c} + R_{d-c})$  with respect to  $B$ , setting the derivative equal to zero, and solving for  $B$  will give the value of  $B$  at optimum operation. Thus

$$\frac{d(R_{a-c} + R_{d-c})}{dB} = 0 =$$

$$39.5akB^{a-1}w(fL/V)^2 - (m/sF)(V/fBA)^2B \times 6.88 \times 10^8$$

Solving this expression for  $B$  we obtain

$$B = \left[ \frac{17.4mV^4 \times 10^6}{akwf^3(LA)^2sF} \right]^{1/a+2} \text{ maxwells per square inch} \quad (14)$$

#### Air Gap Calculations

Resistance per foot of copper wire at 20°C may be written

$$R = 2^n/3 \times 10^{-4} \text{ ohms per foot} \quad (15)$$

Solving for wire size we find that  $n = 50.79 + 10\log R$ , but  $R = R_{d-c}/mN$ , and therefore

$$n = 50.79 + 10\log(R_{d-c}/mN) \quad (16)$$

A well-known expression for inductance is

$$L = 3.19N^2 \times 10^{-8} (R' + l/\mu\Delta A) \quad (17)$$

In the subject case  $R'$  may be approximately expressed as  $2g/A_p$ ,

where  $g$  is the width in inches of the actual air gap between  $E$  and  $I$  pieces at the butt joint. This neglects fringing. Roters<sup>8</sup> has developed a method for computing air gap reluctance which takes fringing into account. By this means  $g$  may be corrected analytically. For ordinary manufacturing purposes all that is required is a general idea of gap size, and the approximate method will usually be found quite sufficient. As a matter of fact, after the coil is manufactured and assembled the gap is adjusted so that the coil inductance will be exactly the value desired.

Substituting the foregoing approximate value of  $R'$  in Eq. (17) we obtain for gap width

$$g = (N^2A_p/2L) 3.19 \times 10^{-8} - (LA_p/2\mu\Delta A) \text{ inches} \quad (18)$$

#### Measured Quantities

Experimentally obtained curves for  $k$  and  $a$  for a number of magnetic materials are given in Fig. (3) and (4) respectively. These curves are obtained as follows. A sample stack of the material to be tested is obtained and a coil of any convenient size and number of turns is mounted over the core. The core is butt stacked with a gap. Inductance and  $Q$  of the test unit are measured at a number of representative voltages—enough to cover a sufficiently wide range of flux densities—for several values of fre-

quency as parameters. (The author has used a General Radio impedance bridge with good results.)

The effective resistance as obtained from Eq. (13) is

$$R_{a-c} + R_{d-c} = 2\pi fL/Q \quad (19)$$

$R_{d-c}$ , the direct-current resistance of the coil is easily measured.  $R_{a-c}$ , the effective alternating current of the coil can then be computed from Eq. (19) using the measured value of  $Q$ .

To determine core loss, coil current is obtained from  $I = V/2\pi fL$  where  $V$  is the sinusoidal voltage measured directly across the coil after the bridge has been balanced. Obviously the input impedance of the voltmeter used for this measurement should be much greater than  $2\pi fL$ . Knowing the coil current, the core loss can be calculated from Eq. (3). The core should be weighed or its weight computed by counting laminations. Core loss is then

$$P_{cl} = I^2R_{a-c}/w \text{ watts per pound} \quad (20)$$

From Eq. (10)  $B = (V/4.44fNA) \times 10^8$ .

With this information, core loss curves can be plotted as in Fig. 5, with frequency as parameter, on log-log paper. These curves will all be nearly straight lines. The slope of these curves is the exponent  $a$ , and  $k$  can be computed for the corresponding frequency by taking the core loss at any flux density on the

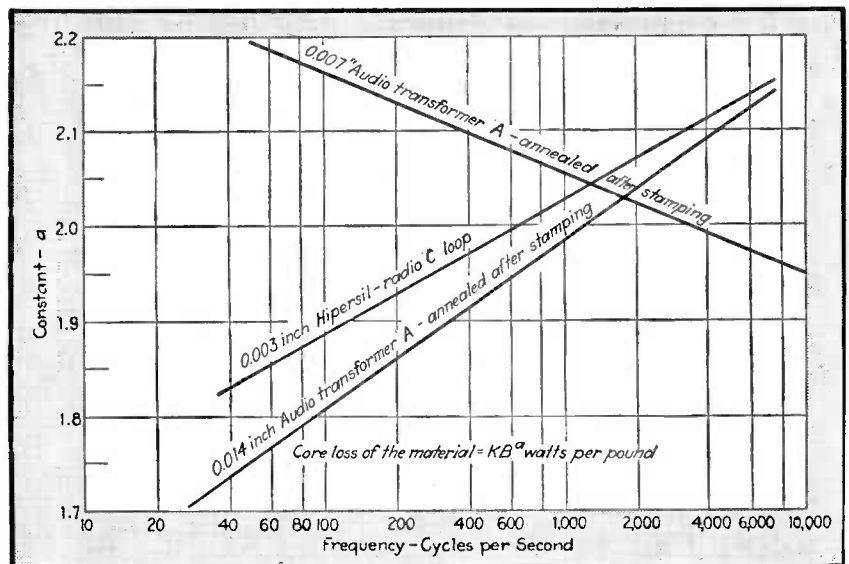

FIG. 3—Experimentally determined curves show values of  $a$  in Eq. (1) for three types of core material as a function of frequency

curve and substituting in Eq. (1). From the data of Fig. 5 and similar curves, Fig. 3 and 4 are obtained. These curves justify the original assumption that core loss may be represented by  $P = kB^a$ . To complete the data necessary for designing an inductance, a typical curve of incremental permeability vs flux density is reproduced in Fig. 6, but it will be seen later that these values are not critical.

### Design Procedure

A typical problem will be solved to illustrate design procedure. Given:

- Required inductance of 5 henrys
- An available space of  $2\frac{1}{4} \times 2 \times 1\frac{1}{4}$  inches
- Operating voltage of 10 volts
- An operating frequency of 1,000 cycles per second
- Core material available is Allegheny audio transformer A steel, annealed after stamping, laminations in 0.014-inch thickness (29 gage)

To find:

- Number of turns in coil
- Wire size for winding
- Lamination size and stack

Gap width  
Q of coil

Designing for a square core cross-section, we see that a scrapless lamination with  $t = \frac{3}{8}$  inch will fit the space allowed. Finished dimensions will require a space  $2\frac{1}{4} \times 1\frac{1}{4} \times 1\frac{1}{4}$  inches as illustrated in Fig. 7.

First the physical design parameters will be calculated from the required conditions and the previously developed equations, and then the coil and core will be designed. Utilizing the same notation as previously, from the dimensions of Fig. 7 we obtain

$$m = 2 \left( 1\frac{1}{2} \right) + 2 \left( \frac{3}{4} \right) = 4.5 \text{ inches}$$

$$l = 4 \left( 1\frac{1}{8} \right) = 4.5 \text{ inches}$$

$$w = 0.615 \text{ pounds}$$

$$A = \left( \frac{3}{4} \right) \left( \frac{3}{4} \right) (0.9) = 0.505 \text{ square inches}$$

$$A_g = \left( \frac{3}{4} \right) \left( \frac{3}{4} \right) = 0.563 \text{ square inches}$$

$$s = \left( 1\frac{1}{8} \right) \left( \frac{3}{8} \right) = 0.422 \text{ square inches}$$

It will be assumed that the ratio of copper area in the window to window space area is 0.3. This is usual, somewhat less with smaller laminations, and somewhat greater with larger laminations. From Fig.

(4) for 0.014-inch audio transformer A steel, annealed after stamping,  $k$  at 1000 cycles is  $1.3 \times 10^{-9}$ . From Fig. 3,  $a = 1.987$ .

From Eq. (14)  $B$  is calculated to be 89.2 maxwells per square inch. From Eq. (6) and (12),  $R_{a-c}$  and  $R_{c-e}$  are calculated, giving  $R_{a-c} = 592$  ohms and  $R_{c-e} = 600$  ohms respectively.  $Q$  is calculated from Eq. (13) using the previously determined values of resistance. This gives  $Q = 26.3$ .

The total number of turns is found to be 5,000 from Eq. (11), and the coil is to be wound of number 35 wire as determined from Eq. (16). Using the value of  $B$  determined previously,  $\mu\Delta$  is found from Fig. 6 to be 1050. Equation (18) gives a gap length of 0.038 inches.

It should be noted that the value of  $\mu\Delta$  need not be accurate for even if it varies by 100 percent, the gap is barely affected.

The coil is designed to fit a window length of  $1\frac{1}{8}$  inches with  $\frac{1}{8}$  inch on each side for a margin. Usable winding length is then  $\frac{5}{8}$  inch. The nominal diameter of number 35 wire is 0.0061 inch, and thus turns per layer =  $(\frac{5}{8})/0.0061 = 143.5$  turns. Allowing 5 percent for irregularities, we can expect the turns

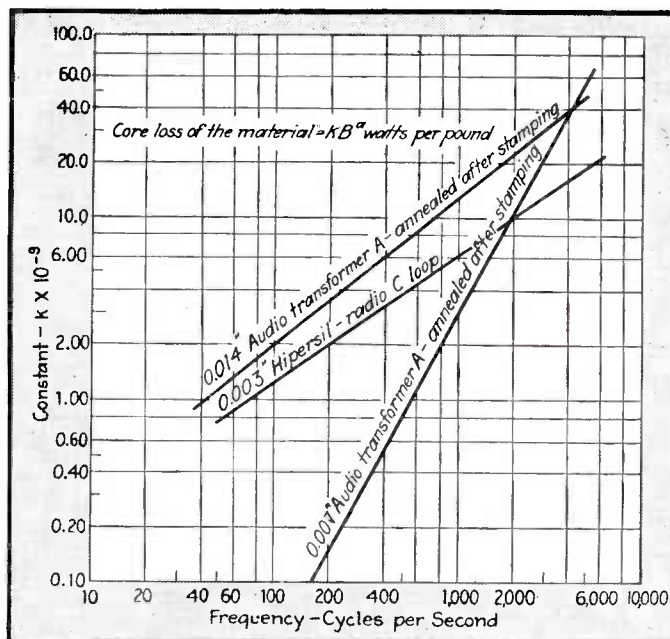

FIG. 4—For use in determining core loss in inductor calculations,  $k$  as determined experimentally for three different materials is given here as a function of frequency

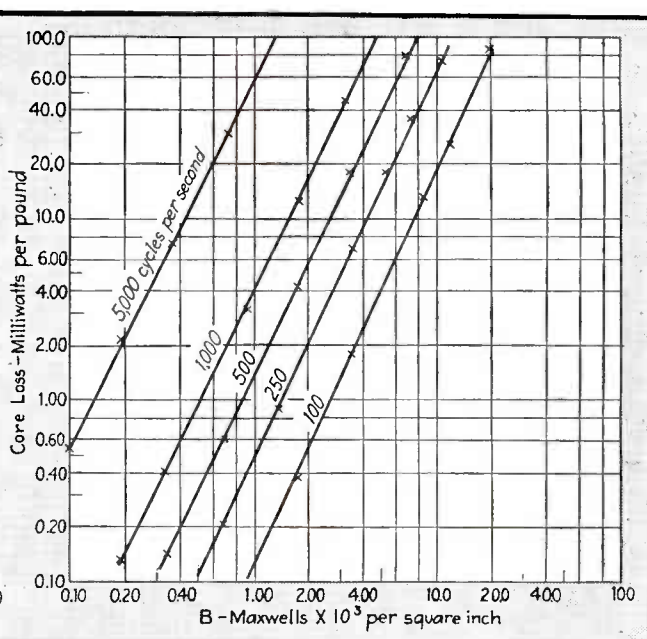

FIG. 5—Core loss measured at several frequencies for a small sample of 0.007-inch high-silicon steel, Allegheny audio transformer A, annealed after stamping

per layer to be  $(0.95)(143.5) = 136$  turns. From previous calculation we found that 5,000 turns were required, therefore the number of layers will be  $5000/136 = 37$  layers.

It should be noted that  $R_{a-c}$  and  $R_{d-c}$  come out nearly equal. This will verify the rule followed by most designers that for optimum  $Q$  the fixed losses represented by  $R_{d-c}$  should be equal to the variable losses represented by  $R_{a-c}$ . If in Eq. (14)  $a$  is set equal to 2, the same result is obtained as when Eq. (6) and (12) are equated and solved for  $B$ . In other words, the rule is accurate if  $a = 2$ . Actually,  $a$  is usually nearly 2.

The coil as designed above was constructed and with the gap adjusted to give  $L = 5$  henrys at 1,000 cycles and 10 volts,  $Q$  was found to be 25.9, which represents an error of 1.5 percent. The gap was actually found to have been adjusted to be about 0.060 inch as against about 0.04 inch computed. This discrepancy is due to fringing.

#### Effect of Varying Inductor Parameters

Suppose that it is desired to reduce the size of the inductor by using a  $\frac{1}{2}$ -inch scrapless E-I lamination with a  $\frac{1}{2}$ -inch stack. What is the effect of this change in physical constants on the characteristics of the coil if the inductance is to remain 5 henrys at 10 volts and 1,000 cycles? Taking  $F = 0.25$  we find that

$$\begin{aligned} B &= 209 \text{ maxwells per square inch} \\ R_{d-c} &= 994 \text{ ohms} \\ R_{a-c} &= 935 \text{ ohms} \\ Q &= 16.3 \\ N &= 4,790 \text{ turns} \\ n &= \text{No. } 39 \end{aligned}$$

This is obviously not as good as the first coil because the  $Q$  is lower and number 39 wire is harder to handle.

Suppose the same  $\frac{1}{2}$ -inch lamination is used but with a one-inch stack, what then? The results are

$$\begin{aligned} B &= 135 \text{ maxwells per square inch} \\ R_{d-c} &= 796 \text{ ohms} \\ R_{a-c} &= 800 \text{ ohms} \\ Q &= 19.7 \\ N &= 3,710 \text{ turns} \\ n &= \text{No. } 38 \end{aligned}$$

This coil is better than that obtained with a  $\frac{1}{2}$ -inch stack but not so good as that obtained with the  $\frac{3}{4}$ -inch lamination.

Following this lead, suppose the

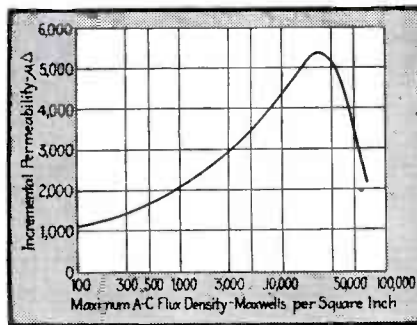

FIG. 6—Incremental permeability characteristic of 0.014-inch Allegheny audio transformer A core steel

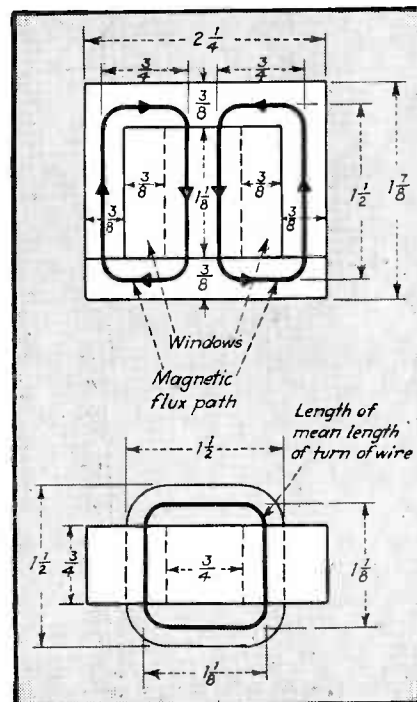

FIG. 7—Dimensions of inductor calculated by method developed in text

coil is redesigned to use a 1-inch scrapless lamination, with a one-inch stack. Taking  $F = 0.35$ ,

$$\begin{aligned} B &= 48.5 \text{ maxwells per square inch} \\ R_{d-c} &= 413 \text{ ohms} \\ R_{a-c} &= 415 \text{ ohms} \\ Q &= 38 \\ N &= 5,180 \text{ turns} \\ n &= \text{No. } 32 \end{aligned}$$

If a  $Q$  of 26 is not high enough for the first case that was computed and more space is not available, will using an 0.007-inch lamination thickness in the same size lamination, i.e.,  $\frac{3}{4}$ -inch scrapless, improve the coil? New values of  $a$  and  $k$  are found from the graphs. The results are

$$\begin{aligned} B &= 117.5 \text{ maxwells per square inch} \\ R_{d-c} &= 362 \text{ ohms} \\ R_{a-c} &= 312 \text{ ohms} \\ Q &= 46.6 \end{aligned}$$

$$\begin{aligned} N &= 3,880 \text{ turns} \\ n &= \text{No. } 34 \end{aligned}$$

As might have been expected, a thinner lamination will improve the  $Q$ .

Taking the original coil, 5,000 turns of number 35 wire on a  $\frac{3}{4}$ -inch E-I,  $\frac{3}{4}$ -inch stack, Allegheny audio transformer A steel, annealed after stamping, 0.014 inch thick, operated at 10 volts, what happens if the frequency is changed to 500 cycles? Results are

$$\begin{aligned} B &= 226 \text{ maxwells per square inch} \\ R_{d-c} &= 600 \text{ ohms} \\ R_{a-c} &= 385 \text{ ohms} \\ Q &= 15.95 \\ L &= 5.02 \text{ henrys} \end{aligned}$$

If the frequency is maintained at 1,000 cycles, but voltage is increased to 20 volts, what is the effect?

$$\begin{aligned} B &= 178 \text{ maxwells per square inch} \\ R_{d-c} &= 600 \text{ ohms} \\ R_{a-c} &= 586 \text{ ohms} \\ Q &= 26.5 \\ L &= 5.01 \text{ henrys} \end{aligned}$$

It should be noted that due to the large air gap, the inductance remained practically independent of voltage and frequency.

Thus the basic design equations may be used and applied to almost any magnetic material, regardless of shape or size, and the effects of various parameters may be easily computed.

#### REFERENCES

- (1) Roters, H. C., "Electromagnetic Devices", John Wiley and Sons, Inc., New York City, 1941, Chapter VI.
- (2) Allegheny Ludlum Steel Corp., Technical Bulletins EM-1 EM-2 and EM-3, Brackenridge, Pa., 1939.
- (3) Roters, H. C., "Electromagnetic Devices", John Wiley and Sons, Inc., New York City, 1941, Chapter V.

#### BIBLIOGRAPHY

- (1) Roters, H. C., "Electromagnetic Devices", John Wiley & Sons, New York, 1941.
- (2) Allegheny Ludlum Steel Corporation Technical Bulletins EM1, EM2, EM3.
- (3) Arguimbau, L. B., Losses in Audio Frequency Coils, *General Radio Experimenter*, 11, 6, Nov., 1936.
- (4) McElroy, P. K., and Field, R. F., How Good is an Iron Cored Coil?, *General Radio Experimenter*, 16, 10, Mar., 1942.
- (5) E. E. Staff, M.I.T., "Magnetic Circuits and Transformers", John Wiley and Sons, New York, 1943.
- (6) Spooner, Thomas, "Properties and Testing of Magnetic Materials", McGraw-Hill Book Co., Inc., 1929.
- (7) Everitt, W. L., "Communications Engineering", McGraw-Hill Book Co., Inc., 1937.
- (8) Terman, F. E., "Radio Engineering Handbook", McGraw-Hill Co., Inc., 1943.
- (9) Hanna, C. R., Design of Reactances and Transformers Which Carry D. C., *Electrical Engineering*, Feb., 1927.
- (10) Dagally, W., Alternating Current Inductance Coils and Transformers, *Wireless Engineering*, Jan., 1936.
- (11) U. S. Steel, Electrical Steel Sheets, Technical Bulletin No. 2.

# HARMONIC SUPPRESSION for Aircraft Generators

Consideration of effects of wave-form distortion in 400-cycle and other high-frequency aircraft and marine generators, and procedure for designing a series-resonant filter to reduce harmonic content. The third harmonic requires maximum suppression

**T**HE need of a frequency-discriminatory network capable of passing power and suppressing harmonics from an alternating source has grown with the expansion of the electric power field into frequencies higher than 60 cycles. For instance, the popularity of 400-cycle power for aircraft and small marine craft has called for the use of small generators which often have poor wave form characteristics.

In small high-frequency generators (400 to 2600 cycles) the wave form distortion may reach 30 percent. If electrical measurements are to have much significance and be subject to duplication later, they must be based on a known wave form, preferably a sine wave. This paper will discuss the design and characteristics of one type of band-pass power filter that has proved highly successful in correcting wave form at these frequencies.

Power filters generally require the suppression of multiples of the fundamental frequency. The only circuit available which will produce a band-pass effect without shunt arms appears to be a series resonant circuit, as shown in Fig. 1(a). The generator resistance is assumed to be negligible in comparison with the load resistance. The insertion loss of the circuit at the pass frequency is given by

$$\text{db loss} = 20 \log \left( 1 + \frac{X_L}{QR} \right) \quad (1)$$

where  $R$  is the resistance of the load and  $Q$  and  $X_L$  apply to the filter. The loss at any other fre-

quency, assuming that the resistance of the filter coil is negligible in comparison to the load resistance, is

$$\text{db loss} = 10 \log \left[ 1 + \frac{(X_L - X_C)^2}{R^2} \right] \quad (2)$$

In the design of power filters, knowledge of the magnitudes of the harmonic components to be suppressed is of considerable aid. If a sketch of the wave form to be corrected is available, a Fourier analysis will give the magnitude of the harmonics. Such an analysis was made of the output voltage of a 2-kva, 500-cps generator, giving

$$e = \sin x - 0.22 \sin (3x - 25.7^\circ) - 0.118 \sin (5x - 54^\circ) + 0.05 \sin (7x + 36.9^\circ) + 0.033 \sin 9x - 0.02 \sin (11x - 19.3^\circ) + \dots$$

where  $x = \omega t = 2\pi \times 500$  and phase-shift angles are given in terms of their respective harmonics. The analysis was made through the 11th component. The total harmonic content through the 11th was 26 percent. A graphical analysis of this wave is given in Fig. 2.

## Filter Design Procedure

Let us say that the harmonic content of the above-analyzed wave is to be reduced from 26 percent to 5 percent. To reduce the amplitude of the 3rd harmonic from 22 percent to 5 percent of the fundamental amplitude would require a db reduction of  $20 \log (e_3/0.05)$  or  $20 \log (0.22/0.05)$ , which is 12.9 db at 1500 cycles.

But since there are more harmonics than the 3rd to be suppressed, a greater loss of the 3rd than 12.9 db is required. With a 15-db loss at 1500 cycles, the 3rd is reduced from 22 percent to 3.9 percent, the 5th is down to 20 db or reduced from 11.8 percent to approximately 1.2 percent, and the effective sum of the 7th, the 9th, and the 11th is less than 1 percent. The summation of the harmonics is

$$\sqrt{E_3^2 + E_5^2 + E_7^2 + E_9^2 + E_{11}^2} = \sqrt{3.9^2 + 1.2^2 + 1^2 + \dots} = 4.2\%$$

Therefore, this design would suffice. If neglect of the higher harmonics causes greater than 5 percent distortion, a correction may be applied by shunting a capacitor across the output as in Fig. 1(b). This is permissible if the capacitor has a high impedance at the pass frequency. Since the capacitor cur-

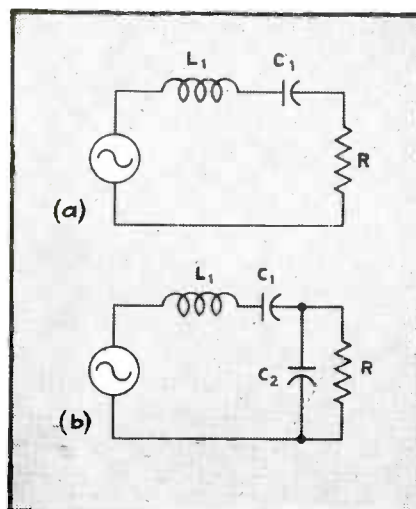

FIG. 1—(a) Series resonant filter and (b) use of a capacitor across the load with the same filter for additional suppression of higher harmonics



By F. W. JAKSHA

Thordarson Electric Mfg. Co.  
Chicago, Illinois

rent is at quadrature with the load current it may be as high as 32 percent of the load current and cause only a 10-percent increase in the generator current.

The addition of a shunting capacitor will cause the resonant frequency of the unit to increase as the load is lessened. The output voltage at the resonant frequency will then be greater than the generator voltage, but the voltage output at the desired pass frequency will still be the same as the fundamental of the generator.

A good test of the filter is to take two voltmeters whose operation is based on two different systems of measurements, such as an rms voltmeter and a peak-reading type. At the output of the generator they will read differently, but at the output of the filter they should read the same if filtering is effective.

#### Determination of Circuit Constants

For a 2-kva, 500-cps, 220-volt unit, the rated current would be 9.1 amperes. The resistance at maximum load would be  $220/9.1 = 24.2$  ohms. Assuming that the aforementioned 15-db reduction at 1,500 cycles would be satisfactory, the determination of  $X_L$  and  $X_C$  follows directly from Eq. (2):

$$15 = 10 \log \left[ 1 + \frac{(X_L - X_C)^2}{R^2} \right]$$

$$= 10 \log \left[ 1 + \frac{(X_L - X_C)^2}{24.2^2} \right]$$

$$\text{At 1,500 cps, } X_L - X_C = \sqrt{24.2^2 \times 31.6} = 136 \text{ ohms}$$

$$\text{At 500 cps, } X_L - X_C = 0 \text{ ohms}$$

Solving the last two equations,  $L$  equals 16.25 mh and  $C$  equals 6.25  $\mu$ f. At full load, the rms voltage of the fundamental across either  $L$  or  $C$  is  $9.1 \times 0.01625 \times 6.28 \times 500 = 465$  volts. Harmonic voltages may either increase or decrease the corresponding peak voltage of  $1.414 \times 465 = 658$  volts.

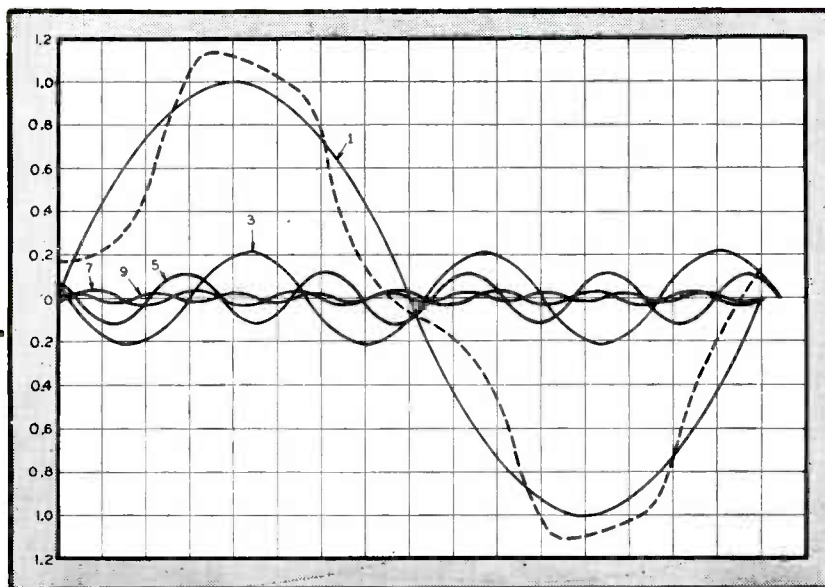

FIG. 2—Graphical analysis of the output voltage of a 2-kva, 500-cps generator. Harmonics are identified by number; the dash-dash curve represents the distorted output wave form. The 11th and higher harmonics are not shown

Assuming that a loss of 5 percent in output is permissible, the coil resistance could be  $0.05 \times 2000/9.1^2 = 1.2$  ohms. This resistance means a dissipation of 100 watts in the filter unit, which would be difficult to obtain without excessive heat rise. A dissipation of 50 watts should be more feasible, thereby requiring a reduction of the coil resistance to 0.6 ohms. Thus, the insertion loss is inherently low since the  $Q$  of the circuit is governed by heat rise in the unit and not by the permissible insertion loss.

In tests made with a power filter unit for a 220-volt, 1-kva, 500-cps generator, there was a slight distortion at full load amounting to about 5 percent as viewed on an oscilloscope. As the load was decreased, the distortion disappeared. Under no-load conditions there was no apparent distortion. A test was also made with the primary of an open-circuited transformer as a load. Again there was no apparent wave-form distortion. With an inductive load the resonant frequency of the system is lowered, but this does not affect the output voltage at the pass frequency.

#### Use of Air-Core Coils

The inductance values required for power filters often permit a choice between air and iron-core coils. In making a decision, a number of disadvantages of iron-cored units must be taken into considera-

tion: (1) the exciting current of iron-core coils introduces additional distortion; (2) with iron cores, only a few turns are needed. This results in high voltages between adjacent turns and between layers, creating difficult insulating problems. The small number of turns also makes accurate design and adjustment of the coils difficult; (3) a large iron core is needed to give a satisfactory  $Q$  and prevent magnetic saturation, and this can make the inductance too large. For these reasons, air-core coils are generally used.

The addition of a band-pass power filter to a generator producing relatively high harmonic content offers several advantages. For example, use of a filter changed the rms-peak ratio from 0.75 for the uncorrected wave to the sine-wave value of 0.707, and changed the average-peak ratio from 0.53 to the 0.636 value for a sine wave. With this wave-form correction, all types of meters calibrated on a sine-wave basis will read accurately.

Wave-form correction usually reduces peak voltages, lessening chances for voltage breakdown of connected electrical components.

Manufacturers will find that motors and transformers that just exceed heat rise limits when tested with voltages containing high harmonics may pass when the wave form is corrected, due to reduction of high-frequency iron losses.

# STUDIO AND CONTROL-ROOM DESIGN

Program-handling equipment for student-operated college-campus broadcast system is simple and fool-proof. Studio can be adapted to production of a wide variety of programs. Control room is versatile yet simple enough for one-man operation

**S**TUDENT INTEREST in all phases of broadcast program production from script writing to on-the-air station operation has given rise to over seventeen college or university campus stations. Although details of each network differ, the most usual method of distribution is wired wireless because of its controlled coverage—usually only the student dormitories—and absence of licensing requirements.

In normal times about 90 percent of the college students have radios in their rooms. Many of them prefer local campus talent; so the listening audiences on the college station's frequency are large. Campus originated programs include campus and world news and sports, in-

By **WILLIAM REAGH HUTCHINS**

*Columbia University  
New York*

terview and discussion programs, debates, comedy, dramatics, and a large proportion of both classical and popular recorded music, with a few live music programs.

Campus studio and program equipment designed to handle such a variety of material is at least as intricate as that of standard broadcast stations, especially since space and cost limitations are usually more stringent.

## Studio Design

Special considerations involved in the design of college studio equipment are as follows:

**COST:** Budgets are usually very limited because most of these networks are run and financed by students with the aid of small subsidies and some advertising.

**SIMPLICITY OF OPERATION:** Equipment is invariably operated by personnel with little or no previous radio experience. Smoothness and quality of programs must nevertheless be as good as that of the majority of broadcast stations in order to hold an audience.

**SIMPLICITY OF MAINTENANCE:** The minimum of care must be required, and trick circuits must be avoided because the maintenance staff frequently may be little better trained than the operators. Sometimes emergency repairs must be made by members of the program department who have absorbed a little technical knowledge by contact with the engineering staff.

**FLEXIBILITY:** Usually only one studio is available for all types of programs. This means that rapid changes in setup, mike placement and personnel must take place between programs with no hitch in the smoothness of the material going out over the air. Dramatic shows must be as easy to handle as other programs. Yet too much flexibility causes a loss of simplicity; so a compromise must be reached.

**COMPACTNESS:** Space is usually very limited. There must be adequate room for all essential operations, and yet, on occasion, the entire station may have to be operated by one person. At other times large numbers of people will be involved in one broadcast.

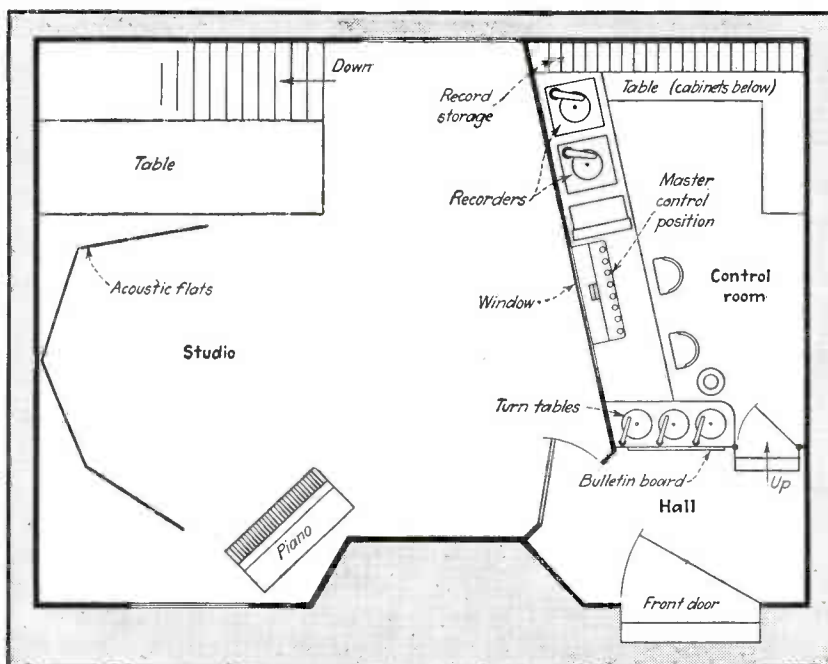

FIG. 1—Studio walls are placed at irregular angles to minimize acoustic standing waves; control room is laid out to minimize personnel required for complete station operation

## Station Layout

The entire space made available for construction of broadcasting fa-



Phonograph position at left has its own mixing controls. Main console at right commands view of studio. Students plan and produce all programs

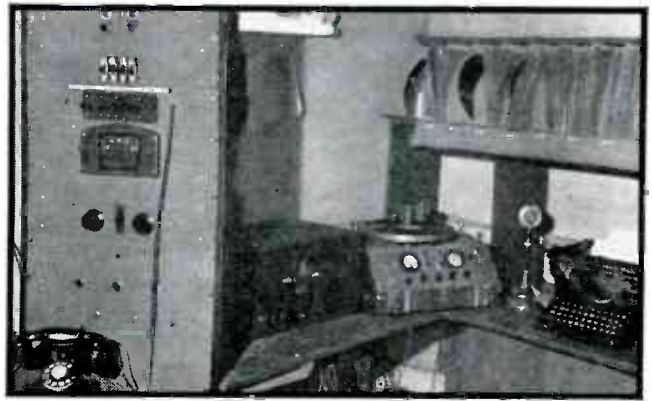

On rack at right of console are the f-m translator and incoming remote pickup lines. Rest of control room is for program planning and record storage

cilities at Columbia University was a room 19 feet by 27 feet overall, but having several jogs in the walls and a stairway which had to be left untouched. Into this room had to be crowded studio, control room and office facilities for the station. The layout finally used is shown in Fig. 1.

Any station requires three space areas: the *studio* itself, the *control room*, and a *hallway* from which these may be entered and which acts as a sound-lock to prevent feedback. The floor of the control room should be raised at least ten inches above that of the studio so that vision is unobstructed by performers standing or sitting in front of the control room window, and so that persons seated in the control room are at the eye level of those standing about microphones in the studio.

It is extremely important that everyone involved in the program be able to see everyone else. As large as possible a soundproof window between studio and control room is therefore essential. The size of this window is only limited by cost. By careful placement and layout it was possible at Columbia to keep the glass area down to two feet by four feet.

#### Studio and Control Room

Studio layout and shape should be determined chiefly by acoustic considerations. Here, however, maximum utilization of the available area had to take precedence. Since proper acoustic treatment of all wall areas was out of the question financially, the walls which were added were set at odd angles

to prevent repeated sound reflections and thus reduce the possibility of distinct standing waves in the room.

Until recently, heavy carpet laid on rug cushion, and Insulite and thin Fibreboard on the control-room wall constituted the only permanent absorbing medium in the room. Acoustic flats, or goboes, consisting of two inches of Rockwool fastened to plywood backing, covered with thin cloth and fitted with braces so they can be moved about the floor, are depended on for acoustic treatment of the sides of the microphone area. The goboes used here are four feet by eight feet, but have proved rather unwieldy; smaller ones would be better.

Control room layout depends largely on the personnel which is expected to be used in regular and emergency operation. At CURC (Columbia University Radio Club) a station manager, announcer, monitor, and turntable operator are normally on duty. In the case of dramatic programs, the director replaces the station manager.

The console is placed under the right end of the window, with equipment racks within easy reach at the monitor's right. At his left sits the station manager or director, with the turntable operator to the left of him. Because the equipment is bent into a broad U, it is possible in an emergency for one person to run the station.

Recording equipment is at the rear of the racks, thus putting it out of the way, and at the same time accessible to all circuits. The remainder of the control room is

devoted to record storage, workbenches and cabinets.

#### Output and Mixing Circuits

With the high turnover and inexperience of the staff, station operation must be easily learned. A switch or dial must materially increase the utility of the apparatus before it is included. This test rejected many gadgets before the final design of CURC was completed. If auxiliary gadgets are found desirable, they should be put on a panel away from the main console where their presence will not confuse inexperienced operators.

The main console of CURC includes six complete input channels and two output channels as shown in Fig. 2. The only controls on the panel are associated with these circuits or the monitoring of them.

Two output amplifiers of identical design are terminated in 500-ohm *unbalanced* transformers with attached load resistors. Across these loads may be connected almost any number of high impedance circuits, such as bridging grids. Bridging transformers and their ills are thus eliminated.

Each outgoing balanced transmitter audio line is fed by a low-gain bridging amplifier, the input grid of which may be switched to either of these program bus circuits. Monitor and cue amplifiers, VU meter, and recorders may similarly be tied to these busses.

High-impedance potentiometer gain controls and electronic mixing circuits are employed. This arrangement eliminates costly and bulky mixing transformers which

can be a source of hum and distortion. Thus simple switching circuits and standard receiver-type volume controls can be used. Controls of the type having a metal contact-band have been in use for over two years with no maintenance or noise.

Loss of high-frequency response when controls are turned down is prevented by using relatively low impedance potentiometers and pentode mixer tubes to reduce shunt capacitance. Since each input circuit may be connected to either output channel or turned off by the channel switches, care must be taken that switching-in of additional channels causes no clicks, changes of level or frequency response. Clicks are prevented by the use of high resistances on the switch sides of all coupling capacitors, while level changes are reduced to 1/2 db per switch by use of 10,000 ohm master gain controls on the output amplifiers.

#### Master Control Position

Starting at the left of the panel, the input circuits of the main console are:

**CONTROL-ROOM MICROPHONE:** Also used for studio talk-back when the studio mikes are dead.

**PHONOGRAPH INPUT:** Brought from four-position mixer on turntable panel.

**TWO STUDIO MICROPHONES:** 50 ohms is used for standard program-

microphone impedance. (Inputs in the console include transformers and preamplifiers. Low impedance allows the use of almost all types of ribbon, dynamic and cardioid microphones interchangeably. It also permits unshielded twisted-pair to be used for emergency microphone cable extensions. As much as a half mile of twisted pair has been used in this manner without bringing hum and noise level up far enough to damage intelligibility.)

**SPECIAL EFFECTS:** Intended to be fed subsequently from a filter and echo-chamber control panel to be mounted in a rack. (This position is now connected through a simple high-pass filter stage to the output of the second studio microphone channel preamplifier. The telephone effect thus produced is satisfactory for a large proportion of dramatic work.)

**GENERAL UTILITY:** The only channel with an input selector switch, the utility input may be connected to an extra output of the phono mixer, to an f-m translator, or to the output of the remote line switching panel. When another studio is added, one of these sources may be replaced by the second studio.

Each mixer gain control has immediately above it the switch which connects it to either output amplifier, or turns it off. The down position of all switches in the station is that normally used when the

circuit controlled by that switch is on the air. This proves a great aid to the memory. The off position is in the middle where practicable.

#### Interlocked Switching

There is only one switch above each control, and each does the same thing; so there is no chance for ambiguity. The talk-back switch is located by itself at one end of the panel (that near the director), and the utility channel selector is at the other end.

The master gain controls are located at the extreme right, while all monitor controls, as well as the studio cue fader are placed at the top of the panel, immediately under the VU meter. The meter projects up into the line of vision, and is illuminated from below.

A separate talk-back power amplifier to feed a speaker in the studio is included in the console. When the studio mikes are not on the air, the input of this amplifier may be fed through a cue fader from either the output of the program channel or from the off positions of the phono and utility channel switches. Operation of the talk-back key automatically disengages these inputs and connects the control-room microphone.

Figure 3 shows how all switches in the console are interlocked, either directly or through relays so that feedback is impossible. The same relays which disconnect the speak-

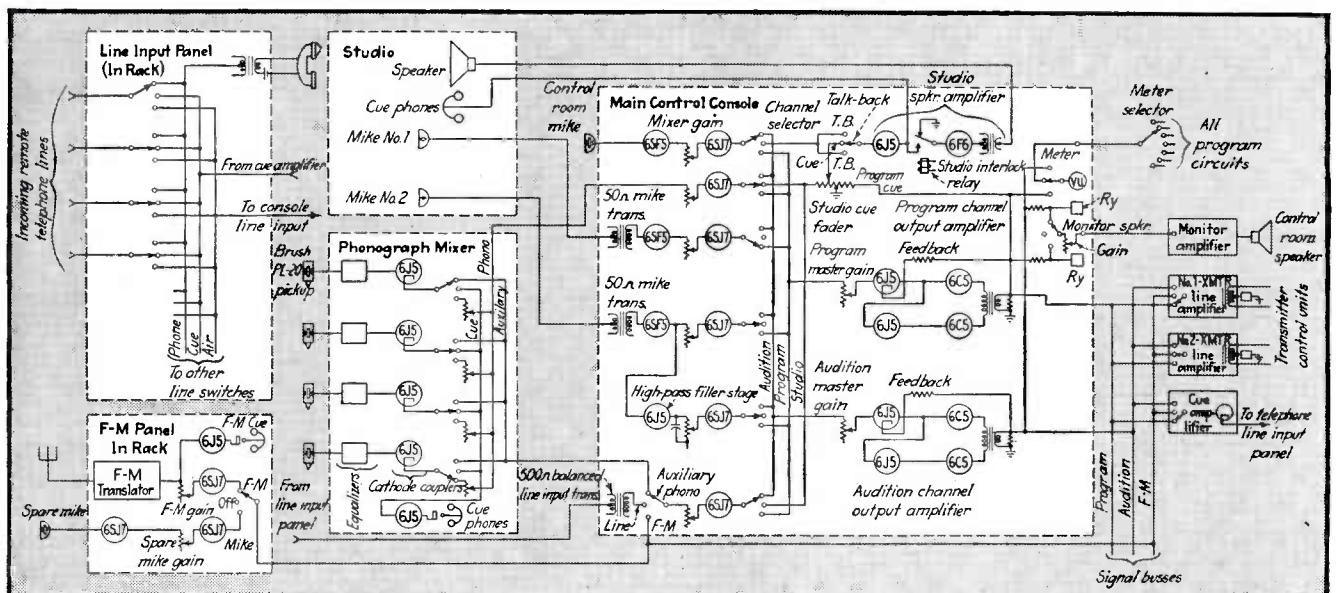

FIG. 2—Single-line diagram of circuits showing location of equipment and type of signal switching used in routing channels through control room

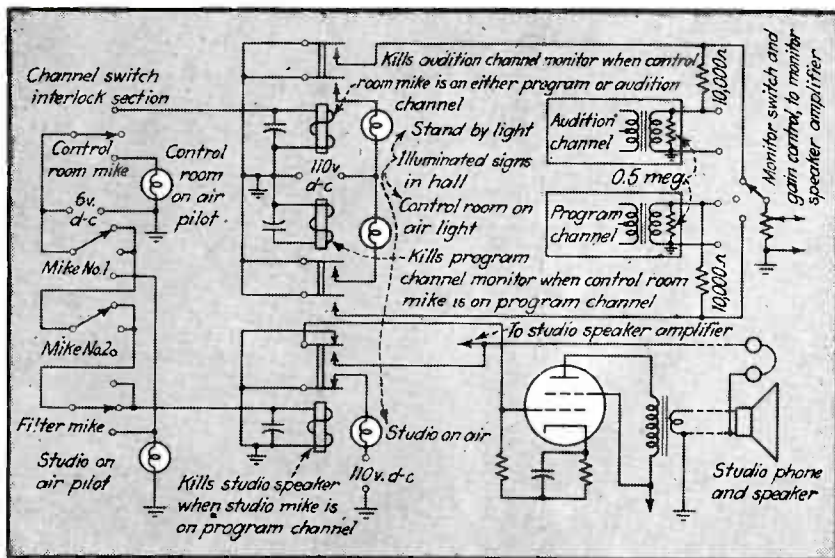

FIG. 3—Associated with console signal-channel controls are interlock relays for operation of hall and pilot lights and studio loudspeaker

ers also are used for stand-by and studio on-the-air lights. When studio microphones are connected to the program channel, the studio loudspeaker is killed; but if connected to the audition channel, the studio speaker may be used with the microphones on because, in this case, the talk-back switch cuts off the control-room speaker. Not only is time saved in rehearsals but this connection permits stunts by feeding the output of the audition channel to the transmitters.

Relays are operated by microphone channel switches. When the microphone is off, the relay is energized. Thus the instant the switch starts to operate, the relay coil is opened, and by the time the microphone is connected the relay has shorted the loudspeaker circuit. Freedom from feedback and clicks is thereby assured.

#### Phonograph Equipment

There are three turntables in regular use. Two of these are synchronous at 78 rpm. The third is a dual-speed rim-driven table normally used at 33½ rpm. Inasmuch as the phonograph operator usually stands up, all three turntables are mounted at a 36-inch height. Turntables are located in the control-room to make integrated direction of the large proportion of programs more simple.

Each turntable is equipped with a 16 inch high-quality, low-pressure crystal pickup, and in addition one of the 78 rpm tables is equipped

with another pickup to facilitate continuous running of sound effects. All four of these pickups are connected through equalizers to a mixing panel at the front of the phono console.

The output of each equalizer goes through a cathode-coupled stage to a key-switch and volume control. In the off or center position of these switches the outputs of the pickups are connected to a headphone amplifier for cueing purposes. Only in the down or air positions are the volume controls connected. The up positions of the switches go to one of the positions of the utility channel switch in the main console.

#### Remote Program Equipment

Single twisted-pair telephone lines run from the studio to most buildings on the campus. These lines terminate at the station in key switches on a phone panel in the rack at the operator's right. In the middle or off positions of these switches cue is fed over all lines. The up positions connect to a telephone handset. When a switch is thrown down it is connected to one of the positions of the utility channel selector switch in the console.

A small battery-operated remote amplifier is used in most cases to feed program over the lines. This amplifier is equipped with a two-position electronic mixer, master gain control, and db meter. One of the microphones and the monitor headphones are used for telephone communication with the handset in

the control room. This is simple and adequate and cuts to a minimum the amount of equipment which must be taken on a remote.

A more elaborate, a-c operated remote amplifier with a built-in public address system has recently been built to meet the needs of elaborate audience-participation shows.

News, public events, and a certain amount of music are rebroadcast from local f-m stations. A standard f-m translator is mounted in the rack at the operator's right with cue and switch circuits. On this panel there is also a separate high-impedance microphone input

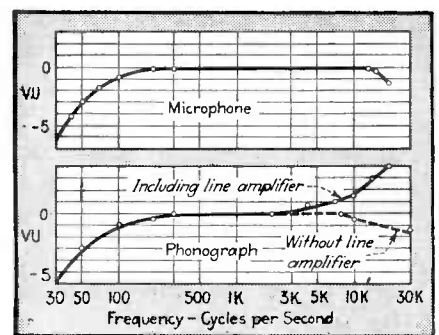

FIG. 4—Response of audio system

with amplifier and gain control.

The f-m panel may be fed directly to the transmitter line amplifiers, thus by-passing the main console when only f-m and announcements are to be broadcast for a long period. The output of the panel may also be connected to one position of the utility channel selector switch. The microphone input on the f-m panel may be used to give an extra studio microphone channel for elaborate shows.

#### Performance Characteristics

Due to use of inverse feedback, a minimum of transformers, and careful design, frequency response is within 1½ db from 60 to 20,000 cycles for all channels from transducer to console output. Distortion is much less than one percent at all frequencies from 50 to 7500 cycles at levels up to 20 db above normal full output. Hum and noise are better than 40 db down from zero level. Although no pains were taken to reduce them still further, greater reduction should be fairly simple were it necessary. Typical frequency response curves are shown in Fig. 4.

# QUARTZ CRYSTAL

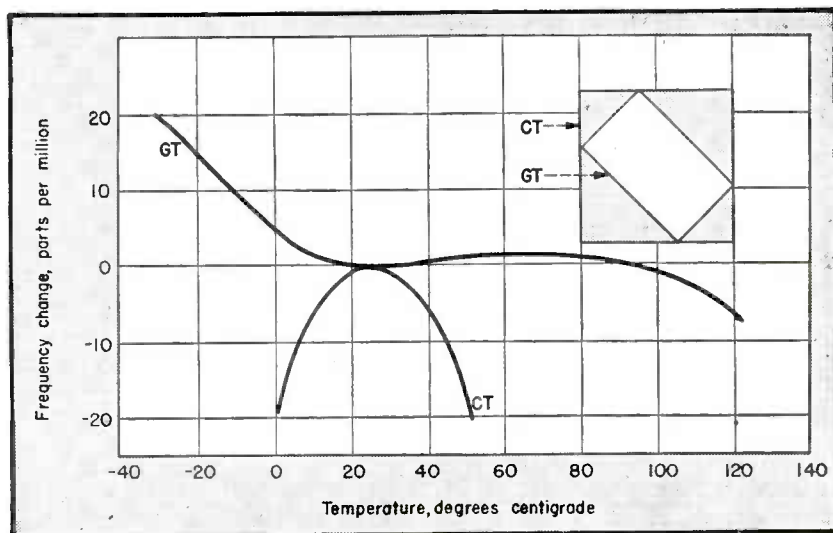

FIG. 1—Comparison of the temperature-frequency characteristics of the CT and GT cuts. The insert shows the angle of cut of each

**J**UST WHAT is a good crystal? Obviously, it must have certain qualifications; it must possess a clean-cut frequency spectrum of its own, free from secondary frequency interference, and free from drift or the tendency to jump under conditions normal to its operation.

Originally most crystals were good crystals. The demands made upon them were no more stringent than those made upon the tubes and circuits of the period. With heat regulation, an X-cut or Y-cut crystal gave greater stability than a heat-regulated tube circuit. To be sure, both these cuts had troublesome secondary frequencies, but with sufficiently patient workmanship these secondary frequencies could be controlled.

Crystals were used long before the war as frequency standards and in narrow band filters. Because of their wide usefulness, and in proportion as the qualifications of circuits themselves improved, the demands made upon crystals steadily increased. For instance, the X-cut crystal had a temperature drift of  $-20$  to  $-50$  parts per million per degree centigrade, and the Y-cut had a drift of  $+60$  to  $+100$

parts per million per degree centigrade. The thinner the crystal, the worse the drift in each instance. Such drift ceased to be acceptable.

## Effect of Angle of Cut

Mathematical analysis in terms of the elastic constants of quartz and the angle of cut was called in to provide crystals which would be good in terms of more exacting requirements. It was found that there were certain angles through which a Y-cut might be rotated about its X-side in cutting from the quartz, for which a minimum of coupling between the desired thickness-frequency and conflicting modes existed. Further, an analysis showed that close by were two other angles of cut which yielded zero drift in the neighborhood of a fixed temperature. It was, therefore, assumed and verified experimentally that crystals cut at either of these latter angles would be desirable both for their zero drift and the relative purity of their vibratory mode. Thus the AT and BT crystals were arrived at.

These were highly desirable cuts. So long as a relatively small band about their points of zero temper-

By **C. W. FRANKLIN**

Cambridge Thermionic Corporation  
Cambridge, Mass.

ature drift was satisfactory, they left little to be wished for in their frequency class. However, outside of this band, they had a small but by no means negligible drift increasing parabolically on either side. They were, moreover, limited as to range by the fact that they were thickness vibrators, since it was not practicable to make them too thick or too thin.

To serve the low-frequency range, the CT and DT crystal plates, cut at about  $90$  deg from the BT and AT respectively, and vibrating in face shear, were devised. These, too, had zero drift at preassigned temperatures and were parabolic in drift elsewhere. Because their faces governed their motion, they had to be center-mounted and were, therefore, more difficult than the preceding crystals to handle. But they filled in the frequency range for zero-drift crystals down as far as  $70$  kilocycles.

## The GT Type

There was still, however, no crystal having zero drift over an extended range. As a result of adroit mathematical and physical reasoning, a crystal, cut at a  $45$  deg angle from CT blanks and thereafter very carefully dimensioned, was conceived, and had a drift of only one part in a million over a range of  $100$  deg centigrade. Its frequency range is from  $60$  to  $1000$  kc, approximately. This is the remarkable GT crystal. Its temperature coefficient is illustrated in Fig. 1 and compared with that of a CT blank.

Finally, in the very low-frequency range, there are the MT longitudinally vibrating crystal (which may be given zero temperature coefficient for certain length-width ratios), and the NT which vibrates

# IMPROVEMENTS

War-time need of better quartz crystals by the millions has caused manufacturing techniques to advance under forced draft. Such engineering progress, if encouraged by large demand in peacetime, may lead to still better crystals

in flexure at frequencies as low as 4 kilocycles. The latter approximates zero temperature coefficient in certain ranges.

The current crystal repertory is given in the table. Step by step, the demands have gone up, as step by step the conditions normal to operation have become more extended.

## Future Improvement

How much further can this process go? How much better is the good crystal likely to become?

Mathematically the field has steadily narrowed. Anything as interesting as the GT cut (and comparatively as easy to cut) is not likely to occur again, though it is rash to say that there will not be improvements.

From now on the largest field for improvement must lie in the processes of manufacture. Careless tolerances must be eliminated so that the final product is in all cases true to the designer's original intent. And finally, much more systematic attention must be paid to the question of correct dimensions.

The GT crystal was produced from the CT by a trick of orientation and a very exact apportionment of dimensions. Yet, in general, with such crystals as the AT and BT, such dimensioning as is done is left to the manipulative skill of the crystal finisher. It is still often a matter of art rather than science. Yet a scientific approach to the problem is possible. Advantageous dimension ratios show an amazingly consistent pattern from crystal to crystal and from frequency to frequency. Such knowledge must be codified and made available. Data of the type given in ELECTRONICS, p. 112, June 1945 is a step in this direction. Thus, as the

purely mathematical field of exploration narrows, this important and neglected field of research lies open.

From the beginning, crystals have had a unique role to play in electronics. Wartime need has required crystals to serve from the stratosphere to the equator, from

desert aridity to the supersaturation of the tropics, and their designers have risen to these demands and met them. The post-war world will require them to become still better. Crystal research, working hand-in-hand with manufacturing skill, must produce the good crystal of the future.

LOW-TEMPERATURE COEFFICIENT CRYSTAL CUTS					
Plates					
Cut	Mounting	Frequency in kc	Temperature Coefficient	Range in kc for practicable size	Use
AT thickness shear	Corner clamped or beveled edges	1660 per mm thickness	Zero at temperature controlled by $\alpha'$ -angle	500...4500 (30,000 if odd harmonics used)	Oscillators
BT thickness shear		2500 per mm thickness	Zero at temperature controlled by $\alpha'$ -angle	2000...20,000 (fundamental)	Oscillators
CT face shear	Center-mounted	3100 per mm length	Zero at temperature controlled by $\alpha'$ -angle	100...500	Oscillators, filters
DT face shear	Center-mounted	2100 per mm length	Zero at temperature controlled by $\alpha'$ -angle	70...400	Oscillators, filters
ET face shear and 2nd flexure	Center-mounted	5350 per mm length	Zero at temperature controlled by $\alpha'$ -angle	200...1000	Oscillators (little used)
FT face shear and 2nd flexure	Center-mounted	4700 per mm length	Zero at temperature controlled by $\alpha'$ -angle	140...800	Oscillators (little used)
GT extension	Center-mounted with knife edges on nodal line	3292 per mm width	Zero over 30-deg interval controlled by $\alpha'$ -angle; changes only 2 parts per million over 100 deg C	60...1000	Frequency time standard
Bar Type					
Thin 5 deg X-bar extension length	Center-mounted	280 per cm length	Zero to correct temperature	50...500	Moderate stability medium width filter
-18.5 deg X-bar extension length	Center-mounted	300 per cm length	25 parts per million	50...500	Band-selecting filters
MT	Center-mounted	275 per cm length	Zero over a moderate range about correct temperature	50...500	Pilot chan. filters, osc.
NT flexure	Double-pleated to vibrate in flexure and mounted at two nodal points	180 per cm down according to exact angles and dimensions	Nearly zero at proper temperature	4...50	F-M trans. pilot-chan. filters of carrier cable

# Square-Wave

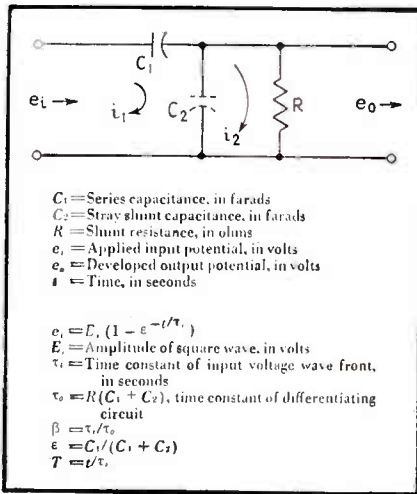

TABLE I—Differentiating circuit and definitions of terms discussed in text

**I**N THIS PAPER the response of a conventional  $R$ - $C$  differentiating circuit to a square-wave voltage having an exponential rise is to be analyzed. Formulas will be derived and curves given which apply to both analysis and design of this type of differentiating circuit. In particular, these formulas and curves enable one to calculate the shape, length and magnitude of the output-pulse voltage of the differentiating circuit.

## Electrical Considerations

Upon sharply differentiating a square-wave voltage it is common experience to find that the magnitude of the output-pulse voltage is only a small fraction of the magnitude of the input. This loss in magnitude is due principally to two things. Firstly, the square wave is never truly square but has a front of finite slope (usually closely exponential in form); secondly, there is always associated with the resistance of the differentiating circuit some stray shunting capacitance which brings about a division of the input voltage between this stray capacitance and the series capacitance of the differentiating circuit.

Intuitively one can see that the more closely the voltage wave approaches a true square wave and

From analytical treatment of pulse-generating circuit, generalized circuit design charts are plotted giving pulse amplitude and length. Time constant of the input wave front and stray shunt capacitance of the differentiating circuit are considered

the smaller is the stray capacitance, the greater will be the output of the differentiating circuit. However, it is difficult to say beforehand just what the amplitude and wave shape of the output pulse will be. It is the purpose of this paper to attempt to answer these questions as well as some others.

## Mathematical Analysis

Derivation of a mathematical expression describing the behavior of this type of differentiating circuit is simple and straightforward. One has but to set up the Kirchhoff voltage equations for this circuit and solve the resulting first order linear differential equation.

Let the differentiating circuit be as represented in Table 1. Applying Kirchhoff's law to this circuit one obtains the following voltage equations

$$e_i = \left( \frac{1}{C_1} + \frac{1}{C_2} \right) \int i_1 dt - \frac{1}{C_2} \int i_2 dt \quad (1)$$

$$0 = - \frac{1}{C_2} \int i_1 dt + \frac{1}{C_2} \int i_2 dt + R i_2 \quad (2)$$

By differentiating both Eq. (1) and (2) with respect to time and then eliminating  $i_1$  from the two resulting equations, one gets a differential equation in  $i_2$

$$R \frac{di_2}{dt} + \frac{i_2}{C_1 + C_2} = \frac{C_1}{C_1 + C_2} \cdot \frac{de_i}{dt} \quad (3)$$

But because  $e_o = i_2 R$  one can con-

vert Eq. (3) into a differential equation in  $e_o$ , i.e.

$$\frac{de_o}{dt} + \frac{e_o}{R(C_1 + C_2)} = \frac{C_1}{C_1 + C_2} \frac{de_i}{dt} \quad (4)$$

Equation (4) is a common first order linear differential equation which may be solved in the conventional way by means of the integrating factor,  $e^{t/R(C_1 + C_2)}$  yielding

$$e_o = \frac{C_1}{C_1 + C_2} e^{-t/R(C_1 + C_2)} \times \int_0^t e^{t/R(C_1 + C_2)} \cdot \frac{de_i}{dt} dt \quad (5)$$

Equation (5) gives the response of the differentiating circuit to an input voltage of any form. To make practical use of this equation it is necessary to express the input voltage as a differentiable function of time.

It should be observed that the lower limit of the integral of Eq. (5) is zero. This follows from the assumption that the differentiating circuit is at rest when the input voltage is applied to the circuit at  $t = 0$ . This assumption also implies that the square wave is longer than the output pulse if the square wave is one of a train of square waves.

## Square Wave Input Voltage

In recent applications, television being one of the common and



# Differentiating Circuit Analysis

By G. P. OHMAN

Naval Research Laboratory  
Washington, D. C.

widely known ones, practice is to differentiate the front or back of a square-wave voltage to obtain a sharp-pulse voltage. Because the differentiation of square waves is therefore relatively important, and because of the impracticability of considering all the possible wave shapes only the differentiation of square waves will be considered further.

It was previously pointed out that one never encounters true square waves in practice since their fronts and backs have finite slopes usually approximately exponential in form. A square wave having an exponential front will be assumed. Let this voltage be represented by the expression  $e_i = E_i (1 - e^{-t/\tau_i})$  where the terms are as defined in Table 1.

This expression gives only the rise of the square wave, not the fall, but this is not a serious limitation because the front and the back of the square wave can be considered separately. If the back of the square wave is similar in form to the front, a pulse similar to that generated in the differentiating circuit by the front, will be generated by the back, but of opposite polarity.

If one differentiates the above expression for  $e_i$  with respect to time, substitutes it in Eq. (5) and performs the indicated integration, one arrives at the expression

$$e_0 = \frac{E_i C_1}{\tau_i (C_1 + C_2)} \cdot \frac{1}{\frac{R(C_1 + C_2)}{\tau_i} - 1} \times \frac{1}{(\epsilon^{-t/\tau_i} - \epsilon^{-t/R(C_1 + C_2)})} \quad (6)$$

Equation (6) is unwieldy, but by substituting  $\tau_o$ ,  $\beta$ ,  $\gamma$  and  $T$  as

defined in Table I, it can be simplified to

$$e_0 = E_i \gamma (\epsilon^{-\beta T} - \epsilon^{-T}) / (1 - \beta) \quad (7)$$

For the purpose of plotting,

however, this expression is unsuitable because it contains too many variables. But  $E_i$  and  $\gamma$  appear only as simple multipliers and

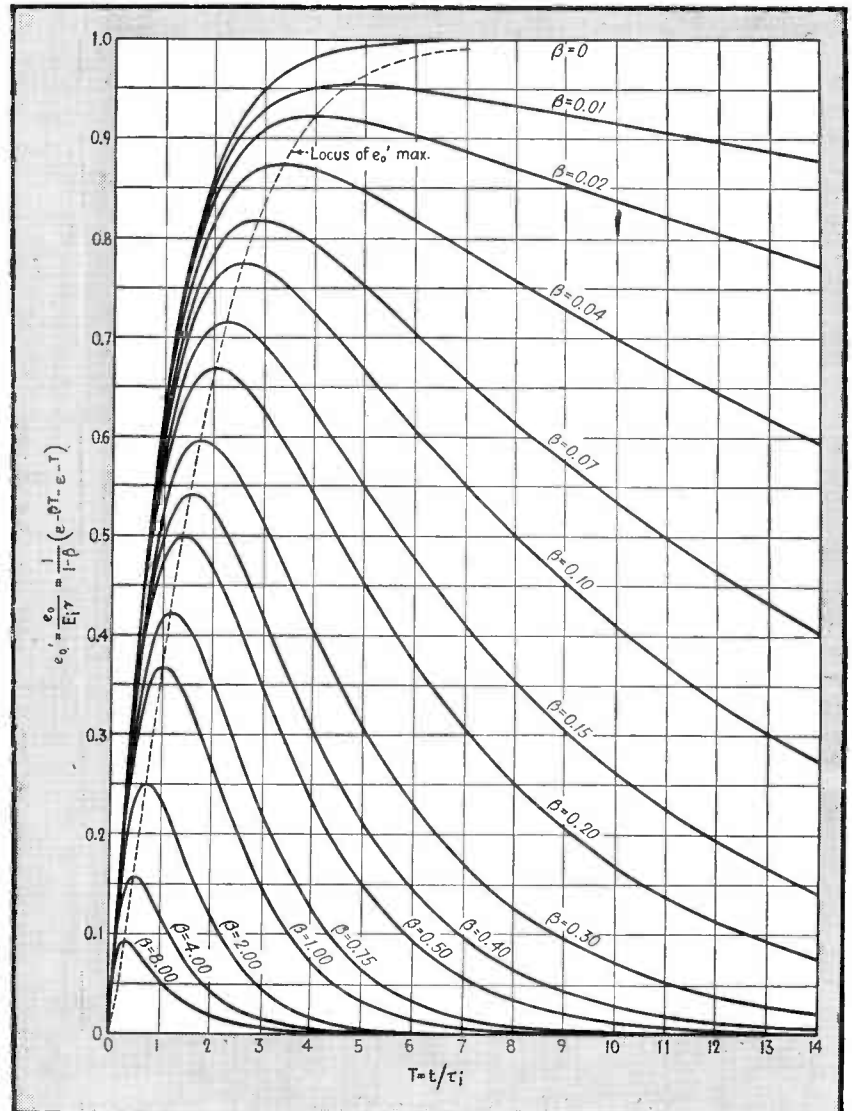

FIG. 1—Family of curves for relative pulse amplitude vs relative time shows the effect on the pulse amplitude and length of the ratio of the input wave-front time constant to the differentiating circuit time constant

hence have no effect upon pulse shape other than its amplitude. By letting  $e_o' = e_o/E_i\gamma$ , one obtains an expression which may be plotted as a family of curves.

$$e_o' = \frac{1}{1-\beta} (\epsilon^{-\beta T} - \epsilon^{-T}) \quad (8)$$

Figure 1 is a plot of Eq. (8).

#### Pulse Amplitude and Delay

Two other quantities which are of importance are the peak voltage reached by the output pulse and the time interval after the arrival of the square wave at which this occurs. Both of these quantities depend upon the value of  $\beta$ . These quantities may be found by maximizing Eq. (8).

$$\frac{de_o'}{dT} = \frac{1}{1-\beta} (-\beta\epsilon^{-\beta T} + \epsilon^{-T}) = 0$$

or  $\epsilon^{-T} = \beta\epsilon^{-\beta T}$  (9)

Substituting Eq. (9) into Eq. (8) one finds that

$$e_o'_{\max} = \epsilon^{-\beta T} \quad (10)$$

Eliminating  $T$  from Eq. (9) and (10), one obtains

$$e_o'_{\max} = \left(\frac{1}{\beta}\right)^{\beta/(\beta-1)} \quad (11)$$

Solving Eq. (9) for  $T$

$$T \text{ for } e_o'_{\max} = \frac{1}{\beta-1} \log \epsilon \beta \quad (12)$$

Equations (11) and (12) are plotted in Fig. 2.

In addition to the curves already mentioned a third set of curves, given in Fig. 3, has been calculated and plotted, which gives an indication of pulse length as a function of  $\beta$ . Pulse length is defined as the time at which the pulse voltage has decayed to a certain percentage of the maximum pulse voltage. Figure 3 gives the  $T$  at which the pulse amplitude has decayed to 10 percent and to 1 percent of its maximum value.

#### Use of Charts

It is tacitly assumed in the derivation of these formulas and curves that the differentiating circuit has negligible loading effect upon the square-wave voltage source. This is not likely to be the case if the source impedance is relatively high compared to the impedance of the differentiating circuit. This should be kept in mind when one chooses the parameters of the differentiating circuit since loading of the voltage source

will increase the time constant  $\tau_i$  of the input wave front. In some cases allowance may have to be made for loading.

On Fig. 1  $e_o'$  and  $T$  are pure numerics and do not per se represent voltage and time respectively.  $e_o'$  must be multiplied by  $E_i\gamma$  to obtain the output voltage,  $e_o$ , and  $T$  must be multiplied by  $\tau_i$  to convert the abscissa scale to a time scale. If this is done the curve corresponding to the proper  $\beta$  will be a chart of the output voltage as a function of time. The curve corresponding to  $\beta = 0$  will be a chart of the input voltage if the ordinate scale is multiplied by  $E_i$  alone and the abscissa scale is multiplied by  $\tau_i$ .

Frequently one wants to know the maximum voltage reached by the output voltage pulse and the time at which this maximum occurs; Fig. 2 gives this information. Here again  $e_o'$  and  $T$  must be treated in the same way as on Fig. 1.

It can be seen upon examination of Fig. 1 that no matter how great  $\beta$  is, that is—no matter how sharply one differentiates the input wave, the front of the output pulse never has a slope greater than that of the input wave. However, increasing  $\beta$  has two desirable effects; it shortens the length of the pulse, and it reduces the time necessary for the pulse to reach its maximum value. Increasing  $\beta$  has one very undesirable effect; the maximum pulse amplitude decreases, consequently it is not generally practical to make  $\beta$  very large.

Examination of Eq. (7) shows that one should keep  $C_2$  as small as possible; a large  $C_2$  in comparison to  $C_1$  results in loss in amplitude of the output voltage pulse because  $\gamma$  becomes appreciably less than unity. A large  $C_2$  also increases the time constant of the differentiating circuit.

#### Illustrative Problem

Response of a given differentiating circuit to a given square wave may quite readily be found using the formulas and charts that have been derived and plotted. For example, suppose that a square wave of 100 volts amplitude and having a front whose time constant is 0.25 microsecond is applied to a differ-

entiating circuit in which  $C_1 = 90 \mu\text{mf}$ ,  $C_2 = 10 \mu\text{mf}$ , and  $R = 5000$  ohms, and suppose one wants to answer the questions:

- (1) What is the equation of the output voltage pulse?
- (2) What is the maximum output voltage?
- (3) At what time will the maximum voltage be reached?
- (4) What is the pulse length, i.e., when will the pulse voltage decay to 1 percent of its maximum value?

To answer question (1) we calculate  $\tau_o$ ,  $\beta$ ,  $\gamma$ , and  $T$  from their equations as given in Table I, obtaining

$$\begin{aligned} \tau_o &= 0.50 \text{ microsecond} \\ \beta &= 0.50 \text{ (coincidence that } \beta = \gamma\text{)} \\ \gamma &= 0.90 \\ T &= 4.0t \times 10^6 \end{aligned}$$

These values are substituted in Eq. (7), giving for the output-pulse voltage as a function of time the equation

$$e_o = 180(\epsilon^{-2t \times 10^6} - \epsilon^{-4t \times 10^6})$$

This equation corresponds to the curve  $\beta = 0.50$  in Fig. 1.

Question (2) is answered by finding the  $e_o'_{\max}$  for  $\beta = 0.50$ , in Fig. 1 which is 0.50 coincidentally, and multiplying this value by  $E_i\gamma$ , or  $e_o_{\max} = (0.50)(100)(0.90) = 45$  volts.

Figure 2 is also used to answer question (3). One finds the  $T$  for  $e_o'_{\max}$  corresponding to  $\beta = 0.50$  and multiplies by  $\tau_i$ , thus  $t$  for  $e_o_{\max} = (1.40)(0.25) = 0.35$  microseconds.

The answer to question (4) is found with the aid of Fig. 3 which shows  $T$  for decay to 1 percent of the maximum to be 12.1 for  $\beta = 0.50$ . This  $T$  times  $\tau_i$  gives the pulse length in time, which is 3.78 microseconds.

#### Design Difficulties

The problem of design, as is usually the case, is more difficult than the problem of analysis. Given a square wave with certain amplitude and rise time it may not be possible to design a differentiating circuit which will produce an output pulse having simultaneously all of the desired characteristics of pulse amplitude, pulse length, and time for pulse to reach its maximum value. It may not be pos-

sible even to satisfy the requirement of pulse amplitude alone, although the requirements of pulse length and time required to reach a maximum may usually be met by differentiating sufficiently sharply.

Unfortunately, as was previously pointed out, the more sharply one differentiates, i.e., the greater is  $\beta$ , the smaller will be the magnitude of the output pulse so it is not generally advantageous to differentiate any more sharply than necessary. Because of this close interdependence of pulse characteristics, one is usually forced to design the differentiating circuit to meet the most urgent requirement first and then to try to satisfy the others if possible.

As an example of design, suppose one wishes to design a differentiating circuit which will produce a pulse of at least 40 volts maximum amplitude and that this maximum should be reached as quickly as possible, given a square-wave input voltage of 100 volts amplitude and having a rise whose time constant is 0.25 microsecond.

A number of assumptions will have to be made in solving this problem. One is in regard to  $C_2$ . If the differentiating circuit is isolated this stray capacitance  $C_2$  is ordinarily quite small, perhaps 1 or 2  $\mu\mu\text{f}$ , but if the differentiating circuit is in close physical proximity to other circuits, and especially if the output is connected to a vacuum tube,  $C_2$  is likely to be higher, say in the order of 10  $\mu\mu\text{f}$ . In this example a  $C_2$  of 10  $\mu\mu\text{f}$  will be assumed.

Another assumption is in regard to  $\gamma$ . Ordinarily one would like  $\gamma$  to be close to unity, but this means choosing a large  $C_1$ . If  $C_1$  is large,  $R$  must be small in order to differentiate sharply. A small  $R$  would make the impedance of the circuit low and possibly load the voltage source to such an extent that the advantage of differentiating sharply would be lost. Usually it is not practical to make  $\gamma$  much larger than 0.90; often, it has to be made smaller. In this example a  $\gamma$  of 0.90 will be chosen since a relatively high output voltage is the principal requirement. It will be seen subsequently that choosing a  $\gamma$  at this point is equivalent to choosing a  $C_1$  and fixing the value of  $R$ .

#### Calculations.

Now because  $\gamma$  has been chosen as 0.90 and  $C_2$  as 10  $\mu\mu\text{f}$ ,  $C_1$  will have to be equal to 90  $\mu\mu\text{f}$  as given by  $\gamma = C_1/(C_1 + C_2) = 0.90$ . Given an  $e_{o\text{max}}$  of 40 volts,  $e'_{o\text{max}}$  will have to be  $e'_{o\text{max}} = e_{o\text{max}}/E_i\gamma = 40/(100 \times 0.90) = 0.45$ . On Fig. 2, corresponding to this value of 0.45 one finds that  $\beta$  can not be greater than 0.65. This means that  $\tau_o = \tau_i/\beta = 0.25/0.65 = 0.47$  microsecond. But  $\tau_o = R(C_1 + C_2)$ , hence  $R(90 + 10) \times 10^{-12} = 0.47 \times 10^{-6} = 4700$  ohms.

As a matter of interest one can find, using Fig. 2 and 3, that  $t$  for  $e_{o\text{max}} = \tau_i T$ , where  $T$  is taken at  $e_{o\text{max}}$ , is  $0.25 \times 1.23 = 0.31$  microsecond, and that the time at which the pulse has fallen to 1 percent of its maximum value is  $\tau_i T$ , where

$T$  is taken at 1 percent, is  $0.25 \times 9.9 = 2.25$  microseconds.

As an example of designing a differentiating circuit for a desired pulse length, suppose one wants the pulse to be down to 1 percent of its maximum value in 1.50 microseconds, given the same input voltage as in the previous example; what must the circuit parameters be?

To find the value of  $T$  corresponding to the 1-percent time we divide the pulse length of 1.50 microseconds by  $\tau_i$ , which is 0.25 microsecond, giving 6.00. From Fig. 3, for this value of  $T$  we find that  $\beta$  is 1.92 hence  $\tau_o = R(C_1 + C_2) = \tau_i/\beta = 0.25/1.92 = 0.13$  microsecond.

Now again an assumption must be made. One can either assume a value for  $C_1 + C_2$  and solve for  $R$ , or vice versa. In this example a resistance of 3900 ohms will be chosen.

As has been previously pointed out, the minimum permissible value of  $R$  is determined by the impedance of the voltage source. If one assumes a value for  $C_1 + C_2$  and this assumption results in a value for  $R$  which is too low, a smaller value of  $C_1 + C_2$  must be assumed. Consequently it is usually advisable to select a value for  $R$  and solve for  $C_1 + C_2$  if either may be chosen. Sometimes, however, as in the previous example, it makes the solution of the problem simpler if a value for  $C_1 + C_2$  is chosen instead. If  $R$  is taken as 3900 ohms,  $C_1 + C_2 = \tau_o/R = 0.13 \times 10^{-6}/3900 = 33 \mu\mu\text{f}$ .

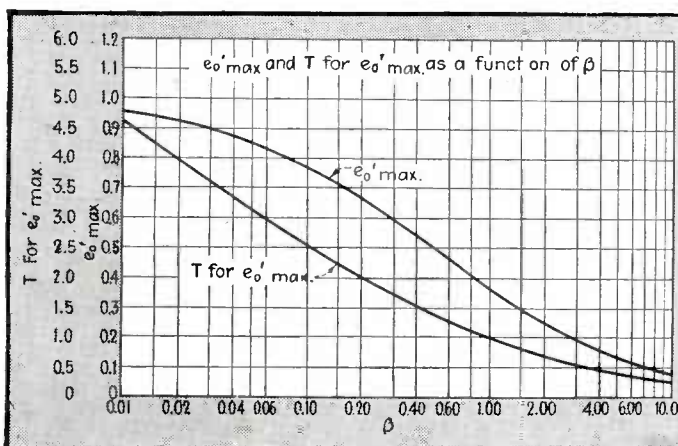

FIG. 2—For use in designing R-C differentiating circuits, these curves give relative amplitude and time for pulse maximum

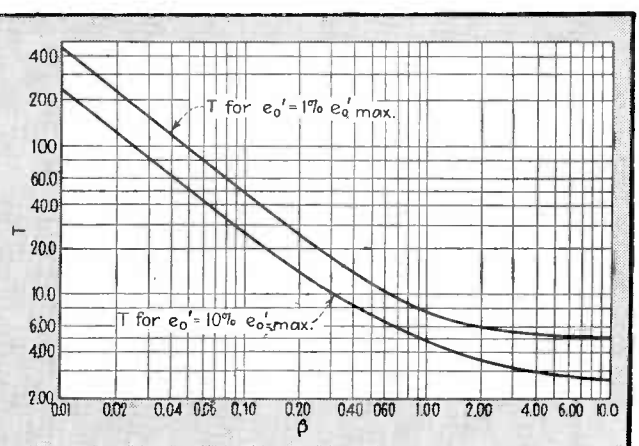

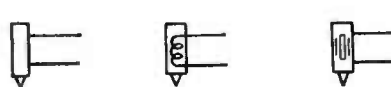

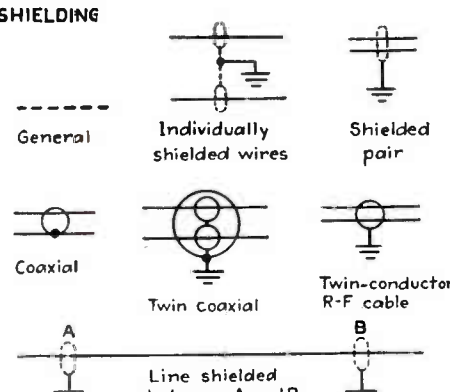

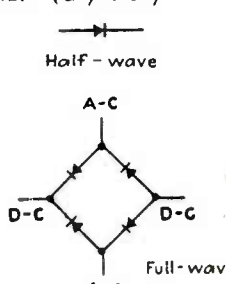



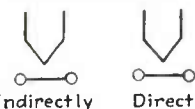

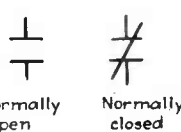

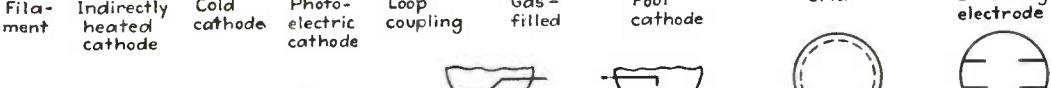

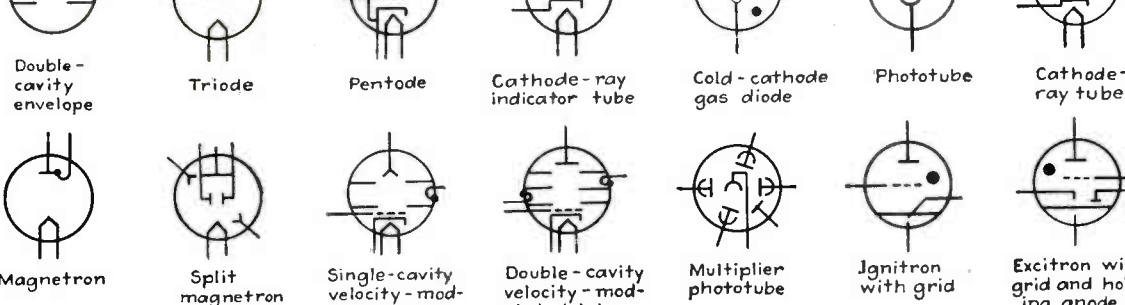

FIG. 3—Curves, giving relative time for the pulse to decay to a small percent of its maximum, indicate pulse length

# Graphical Symbols for

<p><b>RESISTOR</b></p> <p>Fixed</p> <p>Tapped</p> <p>Variable</p> <p>With terminals</p>	<p><b>COIL</b></p> <p>Air-core</p> <p>Magnetic-core</p> <p>Variable coupling</p> <p>Variable core</p> <p>Tapped</p> <p>One movable coil</p> <p>One winding shielded</p> <p>Auto-transformer</p> <p>Variable transformer</p>		
<p><b>CAPACITOR</b></p> <p>Fixed</p> <p>Variable</p> <p>Variable differential</p> <p>Mechanical linkage</p> <p>Split-stator</p>	<p><b>WIRING</b></p> <p>Connections</p> <p>Terminal, contact, or pivot point</p> <p>No connection</p> <p><b>SWITCH</b></p> <p>On-off</p> <p>Multiposition</p> <p>Key</p> <p><b>FUSE</b></p> <p><b>HEATER ELEMENT</b></p> <p><b>GENERAL</b></p> <p>Place legend in or near box</p> <p><b>A-C VOLTAGE SOURCE</b></p> <p><b>MOTOR or GENERATOR</b></p> <p>Use only with identifying notation</p> <p><b>LAMP</b></p> <p><b>BALLAST</b></p> <p><b>METER</b></p> <p>A-Ammeter            mA-Milliammeter            μA-Microammeter            V-Voltmeter            W-Wattmeter            G-Galvanometer</p>		
<p><b>ANTENNA SYSTEM</b></p> <p>Antenna</p> <p>Counterpoise</p> <p>Loop</p> <p>Ground</p>			
<p><b>BATTERY</b></p> <p>One cell</p> <p>Multicell</p>	<p><b>MICROPHONE</b></p> <p>General</p> <p>Single-button</p> <p>Double-button</p> <p>Capacitor</p> <p>Moving-coil</p> <p>Velocity</p> <p>Crystal</p>		
<p><b>LOUDSPEAKER</b></p> <p>General</p> <p>Magnetic</p> <p>P-M dynamic</p> <p>Electrodynamic</p>			

# Electronic Diagrams

<p><b>PHONE</b></p>  <p>Single      Double</p>	<p><b>PICKUP or CUTTING HEAD</b></p>  <p>General      Electromagnetic      Crystal</p>	<p><b>ALARM</b></p>  <p>Buzzer      Bell</p>						
<p><b>CRYSTALS</b></p>  <p>Detector      Piezoelectric</p>	<p><b>SHIELDING</b></p>  <p>General      Individually shielded wires      Shielded pair</p> <p>Coaxial      Twin Coaxial      Twin-conductor R-F cable</p> <p>Line shielded between A and B</p>	<p><b>JACK</b></p> 						
<p><b>RECTIFIER (dry-disk)</b></p>  <p>Half-wave</p> <p>A-C</p> <p>D-C      D-C</p> <p>A-C      Full-wave</p>	<p><b>VIBRATOR</b></p>  <p>Synchronous      Nonsynchronous</p>	<p><b>PLUG</b></p> 						
<p><b>THERMO-COUPLE</b></p> 	<p><b>THERMOELEMENT</b></p>  <p>Indirectly heated      Directly heated</p>	<p><b>SOLENOID</b></p>  <p>Plunger-type</p>						
<p>Abstracted from American Standards Association publications Z32.10-1944 and Z32.5-1944. Note that all lines are the same thickness. Leads can come out of symbols any convenient way.</p>		<p><b>RELAY (deenergized)</b></p>  <p>Make      Break</p>	<p><b>CONTACTORS</b></p>  <p>Normally open      Normally closed</p>					
<p><b>TUBES</b></p>  <p>Grid      Deflecting electrode</p>  <p>Fila-ment      Indirectly heated cathode      Cold cathode      Photo-electric cathode      Loop coupling      Gas-filled      Pool cathode</p>  <p>Anode      X-ray target      Dynode      Ignitor      Excitor      Internal shield      Single-cavity envelope</p>  <p>Double-cavity envelope      Triode      Pentode      Cathode-ray indicator tube      Cold-cathode gas diode      Phototube      Cathode-ray tube</p>  <p>Magnetron      Split magnetron      Single-cavity velocity-modulated tube      Double-cavity velocity-modulated tube      Multiplier phototube      Ignitron with grid      Excitron with grid and holding anode</p>								

## ELECTRONICS REFERENCE SHEET

# Stabilized NEGATIVE

Variations with frequency of amplifier characteristics cause variations of real and imaginary components of negative impedance which is produced. Power handling capacity of the amplifier limits the magnitude of negative impedance that can be produced

**A**MPLIFICATION  $A$  was assumed in Part I to be a real constant. While this may actually be so in a practical amplifier within a certain frequency domain, it is not so at all frequencies between zero and infinity.

## Amplifier Phase Shift

The simplest type of amplifier suitable for producing negative impedances is a two-stage, direct-coupled amplifier the power for which is supplied by an essentially zero-impedance source. Even in this simple case there are shunting capacitances in the tubes and wiring so that although at low frequencies the amplification is real, at higher frequencies, there is phase shift and obviously the character of the negative impedances that can be obtained by means of such an amplifier will not be the simple negative of the positive impedance which is used in

By **E. L. GINZTON**

Research Engineer  
Sperry Gyroscope Company, Inc.  
Garden City, N. Y.

conjunction with that amplifier.

If one considers a high gain amplifier with pentode tubes which utilize filter networks in the screen grid and cathode circuits and rectifier-type power supplies, the phase shift may take a complicated form and the resultant negative impedance will differ greatly from the simple form which would be expected if the phase shift were neglected.

In general, a properly designed amplifier will have a region where the amplification parameter is nearly constant and where the simple equations developed in the Part I hold. Outside of this region phase shift will occur, and the gain of the amplifier will contain an imaginary component. If  $G$  is the

actual gain of the amplifier,  $G_o$  is the absolute value of the amplifier gain in the region where the phase-shift is zero or negligible, and  $\theta$  is the phase shift in degrees referred to the zero phase-shift region, then the gain may be expressed as  $G = G_o (\cos\theta + j\sin\theta)$ . This can be written as

$$G = G_r + jG_i \quad (30)$$

where  $G_r = G_o \cos\theta$   
 $G_i = G_o \sin\theta$

Both  $G_o$  and  $\theta$  must be known for all frequencies before the nature of the negative impedance can be completely specified.

## Phase-Shift Effect on Shunt Negative Impedance

Substituting the vector relation for amplifier gain given by Eq. (30) in Eq. (13) (Part I), one obtains for negative impedance the equation

$$Z_n = \frac{Z_2}{1 - (G_r + jG_i)} \quad (31)$$

Which can be rewritten in the form

$$\frac{1}{Z_n} = \frac{1}{Z_2(1 - G_r)} + \frac{j}{Z_2 G_i} \quad (32)$$

Equation (32) is a familiar expression for two impedances in parallel, and the corresponding circuit is shown in Fig. 10(a). The real part is recognized as the shunt negative impedance proper, and the imaginary part represents an imaginary term which disappears when the imaginary part of the amplifier gain is zero. For the sake of convenience, the functions which determine the real and imaginary parts of the shunt negative impedance will be defined as follows

$$Z_n = \frac{1}{(1/Z_2 F_1) + (1/jZ_2 F_2)} \quad (33)$$

### PART I

Basic ideal circuit and fundamental equations for producing the negative of a positive impedance.  
Eq. (11)-(29), Fig. 1-9, Ref. 1-10

### PART II

Effective on negative impedance of variations with frequency of amplifier parameters.  
Eq. (30)-(56), Fig. 10-20, Ref. 11-13

### PART III

Illustrative applications of negative impedances show how improved circuits can be obtained.  
Eq. (57)-(67), Fig. 21-27, Ref. 14-16

# IMPEDANCES . . . Part II

$$\text{where } F_1 = \frac{1}{1 - G_r}$$

$$F_2 = \frac{1}{G_i}$$

## Phase Shift Effect on Series Negative Impedance

The effect of phase shift upon the character of the series negative impedance can be obtained by substituting Eq. (30) in Eq. (14) and letting  $Z_3' = Z_3 + R_3$  as was done in Eq. (23).

$$Z_n = Z_3'(1 - G_r) + R_1 - jZ_3'G_i \quad (34)$$

where  $R_1$ , the output impedance of the amplifier as before, must now be considered a function of frequency. This equation can be re-written as

$$Z_n = Z_3'F_3 + R_1 + jZ_3'F_4 \quad (35)$$

$$\text{where } F_3 = 1 - G_r$$

$$F_4 = -G_i$$

The series circuit expressed by Eq. (35) is shown in Fig. 10(b). When  $G_i = 0$ , the complex form of the series negative impedance reduces to the simple conception of the negative impedance discussed earlier. The resistance  $R_3$  must be so adjusted that in the region where  $G_i = 0$  the negative resistance due to  $R_1$  just cancels the output impedance of the amplifier. This cancellation obviously cannot hold outside this region because both the magnitude of the series negative resistance due to  $R_3$ , and the output impedance of the amplifier are changing and in general these changes will not counteract one another. The variation of output impedance of the amplifier with frequency due to phase shift and negative feedback is discussed later.

## Calculation of Phase-Shift Effect

If the phase shift and the absolute magnitude of the gain  $G$  of an amplifier are known, then functions  $F_1$ ,  $F_2$ ,  $F_3$ , and  $F_4$  can be computed and the nature of the negative impedance outside the domain of constant  $G$  can be determined. This

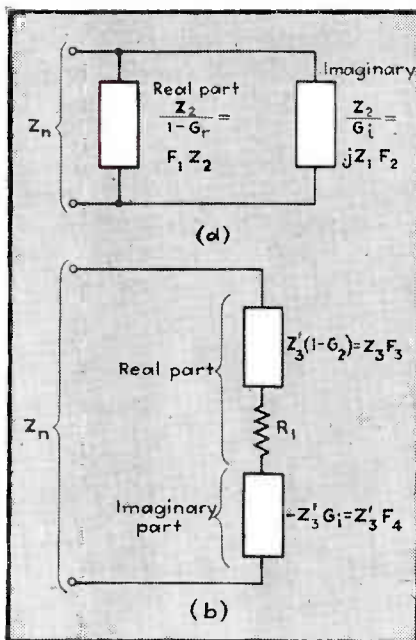

FIG. 10—Effect of phase shift in the amplifier is to produce a change in magnitude of the real component of the negative impedance, and to introduce an imaginary component (a) in parallel with shunt negative impedance, or (b) in series with series negative impedance

means that the exact nature of the amplifier and the types of coupling must be known, as well as the amount of negative feedback used within the amplifier.

To facilitate computation of the above functions, Fig. 11, 12, 13 and 14 give the functions in terms of the amount of phase shift and gain  $G_o$ . These are merely graphical forms of the Eq. (33) and (35) from which the effect of phase shift and the gain for any amplifier on the character of either the shunt or series negative impedance may be obtained.

As an example, Fig. 15 shows a two-stage amplifier with resistance-capacitance coupling and utilizing a moderate amount of negative feedback. The phase shift and the absolute magnitude of the gain for this amplifier are also shown. From these curves and Fig. 11 and 12,  $F_1$  and  $F_2$  were obtained as functions of frequency, and are shown in Fig. 16.

Fig. 16 shows that the function

$F_1$ , which determines the character of the real part of the shunt negative impedance, changes sign abruptly at both low and high frequencies and thus changes the negative impedance into a positive one. In the mid-frequency region,  $F_1$  remains remarkably constant, which means that the negative impedance also is very nearly constant. On the other hand, the imaginary component of the negative impedance introduces an appreciable effect long before the real part changes sign. Once Fig. 16 has been obtained for an amplifier the exact nature of the negative impedance that will be developed by means of that amplifier can be obtained by Eq. (33) or (35).

## Illustration of Effect of Phase Shift

An example of a shunt negative resistance, obtained by means of the amplifier shown in Fig. 15 whose characteristics are described by Fig. 15 and 16, is shown in Fig. 17. These curves were obtained by the method outlined above and checked experimentally by measuring the input impedance of the amplifier as a function of frequency by means of a Wheatstone bridge.

These curves show that the real part of the negative resistance, in the region between 600 and 30,000 cps, is negative. Between approximately 1,000 and 15,000 cycles its value could have been obtained directly by Eq. (13), neglecting phase shift in the amplifier. At frequencies lower than 60 and higher than 30,000 cps the negative resistance changes sign and actually becomes positive. At the extreme frequencies, i.e., at zero and infinity, the amplification of the amplifier is zero, and the input impedance of the amplifier is simply  $R_2$  in series with the output impedance of the amplifier.

These curves also show that even at mid-frequencies the input impedance of the amplifier contains a reactive component. In accordance with the sign of function  $F_2$

shown in Fig. 16 the reactance is capacitive at the high frequencies and inductive at the low frequencies. As will be observed from Fig. 16 and 17, the reactive component of the negative resistance is minimum at approximately the same points where the real component becomes infinite.

#### Limitations Imposed by Phase Shift

In the region between 400 and 5,000 cps the reactive component is ten or more times the real component, therefore the former may be neglected in this region. In the case of negative resistance, the useful range of the negative resistance on the frequency scale must be inside these types of limits, and what happens outside may or may not be of importance. However, if it were a negative reactance that were obtained by means of this amplifier, it is obvious that the imaginary component will contribute a resistance component to the desired negative reactance. In this case it is imperative to know the behavior of the imaginary component for all values of frequency and not merely be satisfied with the knowledge that the resistive component is negligible in the useful range.

The reason for this is that either at the low or high frequencies, depending upon what kind of reactance is being developed by the amplifier, the imaginary component will produce a negative resistance which may cause oscillations in the amplifier. It is plain, therefore, that in no case may the quadrature component of a negative reactance be disregarded, but, on the contrary, its behavior as a function of frequency must be studied carefully, especially in the neighborhood of the point where the real part of the negative reactance becomes infinite in the case of the shunt negative reactance or zero in the case of the series negative reactance.

#### Advantages of Direct-Coupled Amplifier

A two-stage resistance-capacitance amplifier shown in Fig. 15 has 180-degree phase shift at the low-frequency end, which, according to Fig. 16, means that a nega-

tive resistance will be developed by a shunt negative inductance circuit of magnitude  $L_2 F_2$ , where  $L$  is the inductive reactance. The complete results are too complicated to present in a general form. In a special case of a two-stage amplifier with resistance-capacitance coupling, Table I summarizes what is to be expected.

Table I shows that the resistive component developed by a negative reactance in the case of an amplifier capable of 180-degree phase shift at either end of the frequency range is always negative at one end or the other. Therefore, extreme caution must be used in combining negative reactance with other elements.

By means of a direct-coupled amplifier it is possible to obtain negative reactances which do not have a negative resistance component. Referring to Table I, it is seen that a shunt negative inductance has a negative resistance component at the low frequencies. If a direct-coupled amplifier is used, the negative inductance will not have a resistive component at the low-frequency end; only a positive resistive component at high frequencies will be present. Similarly, a negative capacitance may be obtained which does not have a negative resistive component if a direct-coupled amplifier is used to produce series negative capacitance.

Negative resistance, according

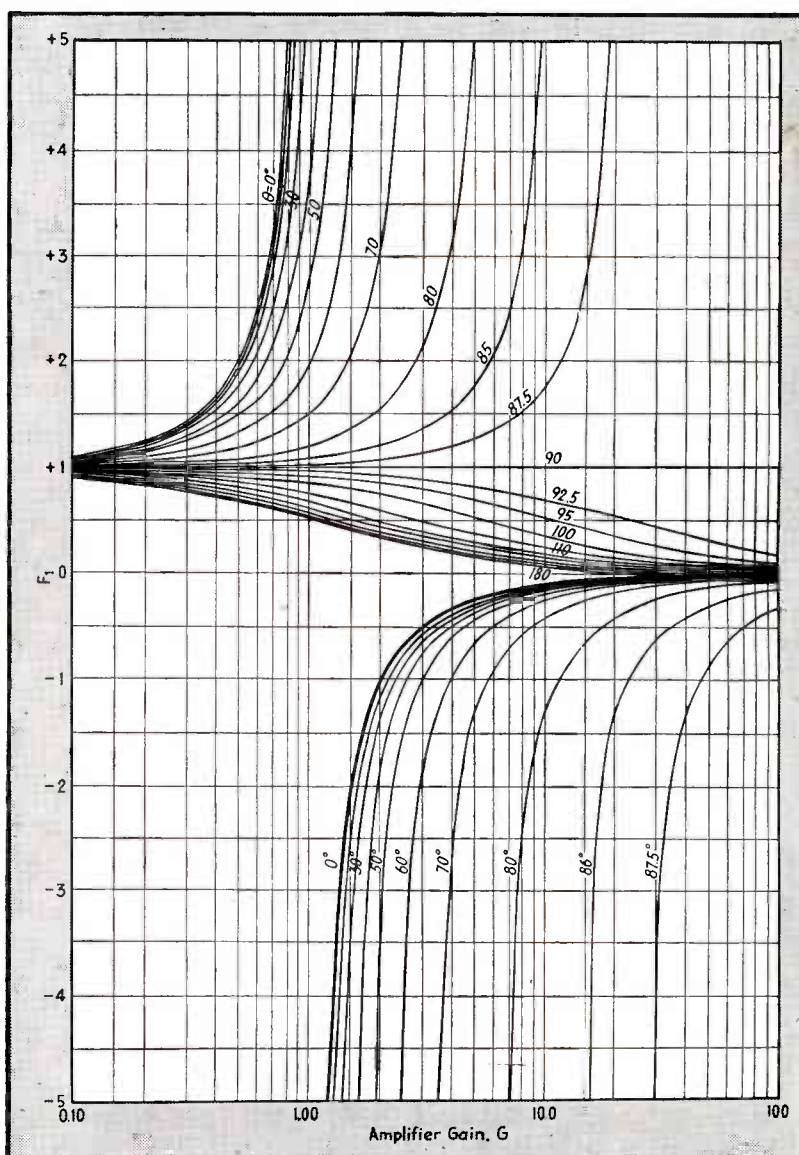

FIG. 11—Variation of  $F_1$  with amplification for use in predicting effect of phase shift on negative impedance



to its definition, must be able to supply power to the circuit to which it is connected. This involves a source of power in the network and because all actual devices have a finite source of power, the range of the negative characteristic must be necessarily limited. The magnitude of negative reactance exhibited by the device is also limited by the same factors as the negative resistance because negative reactances must supply power to the circuit on one half of the cycle and absorb power on the other half cycle.

#### Energy Storage of Negative Reactances

If a sinusoidal voltage whose crest value is  $e$  forces a current of

crest value  $i$  through an impedance  $Z$ , then the following relations may be written

$$P = e^2/2Z \quad (36)$$

$$P = i^2Z/2 \quad (37)$$

where  $P$  is average power dissipated during the cycle in the case of resistance, and average energy stored in inductance or capacitance during the cycle in the case of reactance.

#### Power Limit of Series Negative Impedance

In the case of series negative impedance it is easiest to think in terms of the current that the amplifier can handle. This current is determined by the properties of

the amplifier in the following manner.

If  $E_o$  is the maximum output voltage of the amplifier, then the maximum input voltage that can be developed at the input of the amplifier is  $E_o/G$ , where  $G$  is the voltage gain of the amplifier. Let  $I$  be the maximum current that it is desired to obtain from the negative resistance. It is obvious that impedance  $Z'_s$  must not exceed the value which will make the voltage developed across it equal to the maximum allowable voltage. Thus  $Z'_s$  must not be greater than

$$Z'_{s\max} = E_o/GI \quad (38)$$

Substituting this value of  $Z'_s$  into Eq. (12) and (14), it is seen that the magnitude of the negative impedance is determined by the factor  $E_o/I$

$$Z_{n\max} = R_1 + (E_o/GI)(1 - G) \quad (39)$$

This equation states that the magnitude of the negative impedance a given amplifier is capable of developing depends upon the current that it is desired to draw from the amplifier.

#### Optimum Power of Series Negative Impedance

From Eq. (37) it is plain that the power-handling capability is proportional to the magnitude of the impedance of the circuit and the square of the current through the circuit. Combining Eq. (37) and (39), the power-handling capacity of the series negative impedance is

$$P = \frac{1}{2}I^2R_1 + (E_oI/2G)(1 - G) \quad (40)$$

For any given amplifier there is a value of current at which the maximum possible  $P$  (measured in volt-amperes) can be developed by the negative impedance. This critical current may be obtained by differentiating Eq. (40) with respect to  $I$  and equating the result to zero. This gives

$$\begin{aligned} (\partial P/\partial I) &= IR_1 + \\ & (E_o/2G)(1 - G) = 0 \\ I_{\max} &= \frac{E_o}{2R_1} \cdot \frac{G - 1}{G} \quad (41) \end{aligned}$$

From which the maximum volt-amperes that can be developed by a series negative impedance is

$$P_{\max} = -\frac{E_o^2}{4R_1} \cdot \frac{1 - G}{G} \quad (42)$$

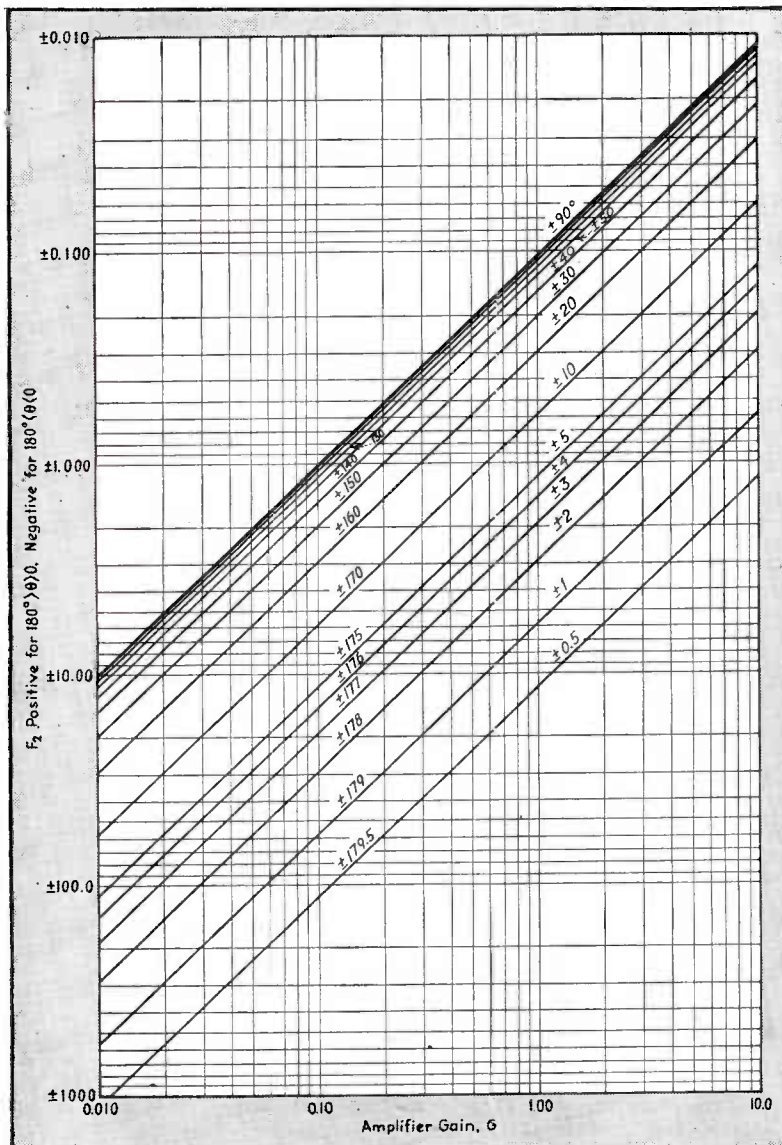

FIG. 12—Variation of  $F_2$  with amplifier gain. Figures 11 and 12 are for shunt negative impedance

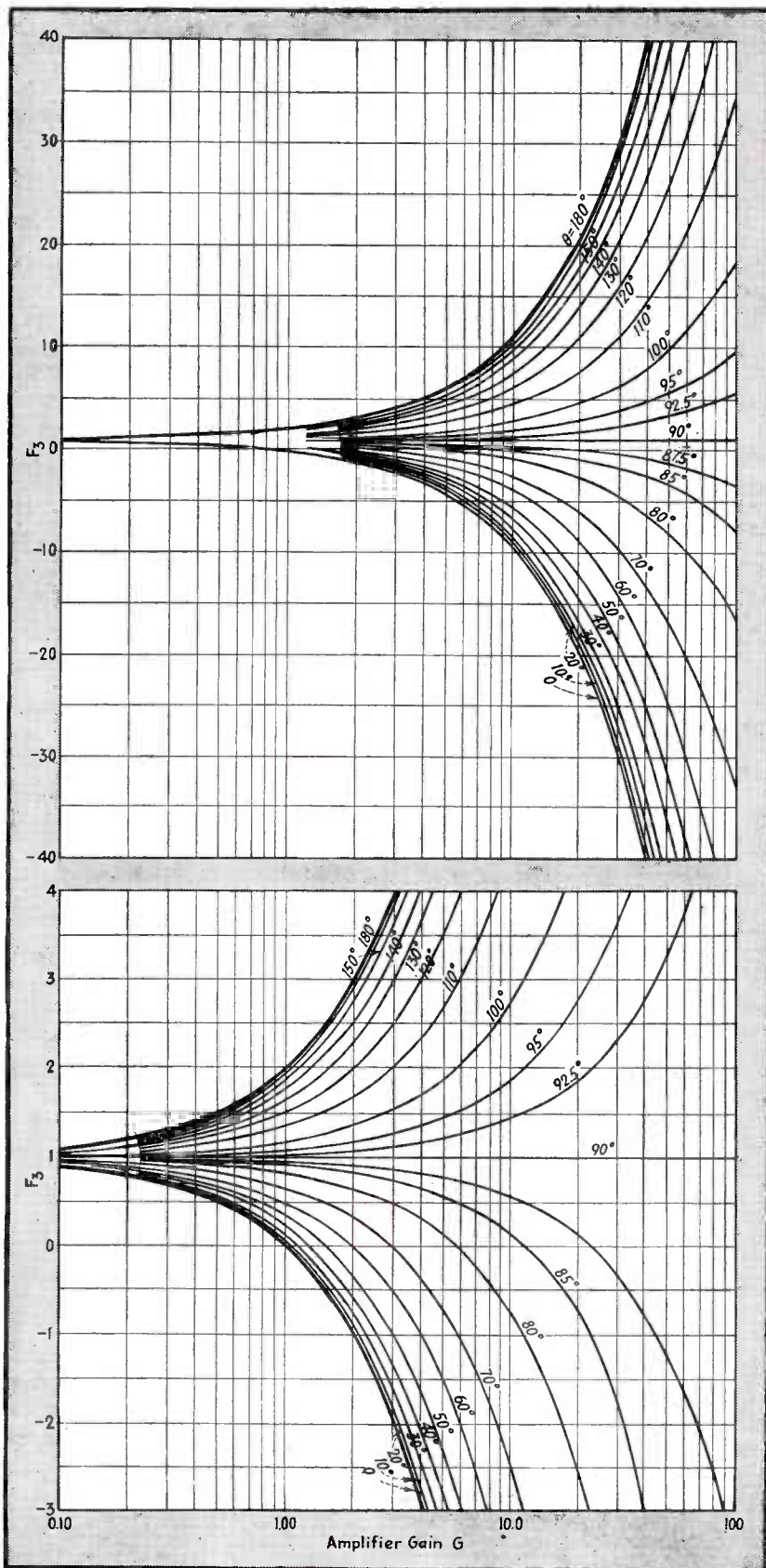

FIG. 13—Variation of  $F_3$  with magnitude and phase of amplification, below is a detail of the middle portion

If the maximum current  $I$  approaches the value for which Eq. (40) becomes zero, the power capability also approaches zero.

An example of a negative resistance that can be developed by an amplifier, together with its power capability is plotted in Fig. 18. It shows, for instance, that the actual amplifier cannot handle unlimited values of current; and that for any given amplifier and for any given maximum current, it is possible to obtain any magnitude of series negative resistance smaller in magnitude than the maximum given by Eq. (39).

#### Power Limit of Shunt Negative Impedances

It was assumed in the derivations of all equations that in this type of negative impedance the grid of the tube does not draw any grid current. Therefore, the peak value of the voltage that appears across the terminals of the negative impedance must not exceed the maximum allowable amplifier input voltage. This voltage is determined by two factors, namely, the direct current bias of the first tube, and secondly, the amount of negative feedback used in the amplifier. If  $\epsilon$  is the maximum voltage that can be applied to the input of the amplifier without producing distortion in the output of the amplifier in the absence of feedback, and  $A\beta$  is the feedback factor, then the maximum voltage that can appear across the input terminals of the amplifier is

$$e_{\max} = \epsilon(1 - A\beta) \quad (43)$$

This equation determines the maximum allowable voltage, and the power capability of the negative impedances will then be given by Eq. (36).

#### Amplifier Frequency Response

The most convenient type of an amplifier suitable for supplying a negative impedance is a two-stage resistance-capacitance coupled amplifier, shown in Fig. 19. It is usually desirable to stabilize such an amplifier with negative feedback to improve its stability and frequency response. The effect of negative feedback on the frequency characteristic must be precisely

known because the frequency characteristic determines the phase shift introduced by the amplifier and this, in turn, determines the type of impedance that results in the frequency region outside the desirable one.

In the following analysis, this notation will be used

$S$  = Effective mutual conductance of the tube

$G_m$  = mutual conductance of the tube

$R_p$  = Plate resistance of the tube

$$R_{eq} = \frac{R_c}{1 + (R_c/R_{g1}) + (R_c/R_p)}$$

$$R = R_{g1} + R_c/(1 + R_c/R_p)$$

$X_c = 1/2\pi fC_c$  = the reactance of the coupling capacitor

$X_s = 1/2\pi fC_s$  = the reactance of the shunting capacitor from plate to ground of each stage, including stray, wiring and tube capacitances

$A$  = voltage amplification of a stage without feedback

$A_o$  = voltage amplification in the mid-frequency region

$L = X_c/R$  = frequency variable for low frequencies

$H = R_{eq}/X_s$  = frequency variable for the high frequencies

The above notation will refer to the first stage, and if the symbols are primed, they will refer to the second stage. Thus,  $A$  is the amplification of the first stage and  $A'$  is the amplification of the second stage.

#### Effect of Bias Circuits

If the cathode resistors in Fig. 19 are unbypassed, then there will be a loss of gain in the stage due to current negative feedback. In the pentode amplifier, this does not modify the frequency characteristic appreciably, so that the only result will be a reduction of the mutual conductance of the tube. It can be easily shown that the effective mutual conductance of a tube is

$$S = \frac{G_m}{1 + G_m R_c} \quad (44)$$

It will be assumed in this derivation that either the cathode is not by-passed in which case Eq. (44) holds, or that it is adequately by-passed in which case  $S = G_m$ . The intermediate case is of no importance because it produces additional phase shift in the amplifier and should be avoided. The additional phase shift due to the improper by-passing of cathode resistor and also of the screen grid dropping resistor is discussed in the literature.<sup>21</sup>

The voltage gain of an amplifier in the mid-frequency region where

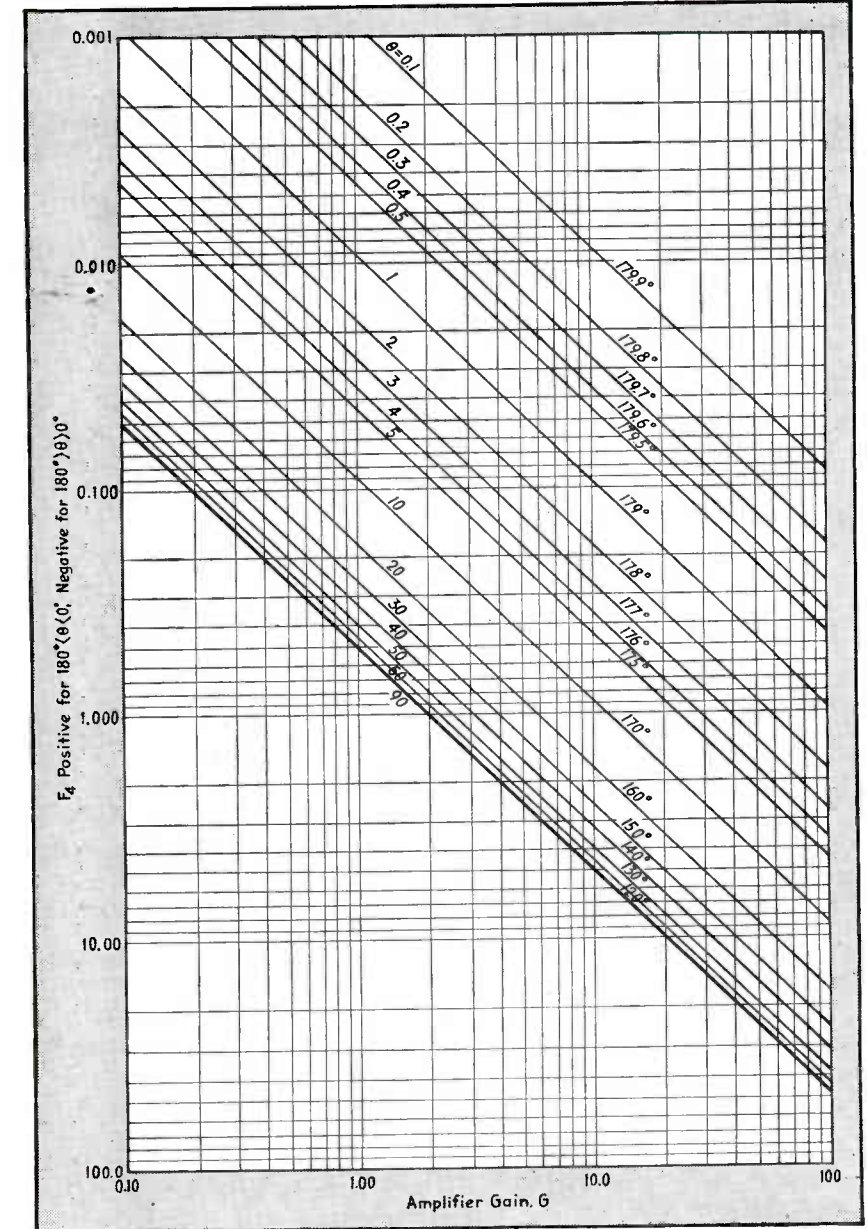

FIG. 14—Variation of  $F_1$  with amplification. Figures 13 and 14 apply to series negative impedance

zero phase shift occurs is given by Terman as<sup>12</sup>

$$A_o = SR_{eq} \quad (45)$$

The voltage amplification at the low frequency end of the frequency range is

$$A = \frac{A_o}{1 - jL} \quad (46)$$

and for the high frequency end.

$$A = \frac{A_o}{1 + jH} \quad (47)$$

These equations refer to the amplification of the first stage of the amplifier shown in Fig. 19. A similar set of equations may be written for the second stage, using the notation given above. It must be remembered that the amplification of

the second stage must take into account the shunting effect of the resistances  $R_o$  and  $R_s$ .

#### Calculation of Amplifier Response

The total voltage amplification of the amplifier will be

at low frequencies

$$AA' = \frac{A_o A_o'}{(1 - jL)(1 - jL')} \quad (48)$$

at high frequencies

$$AA' = \frac{A_o A_o'}{(1 - jH)(1 + jH')} \quad (49)$$

The voltage gain of the amplifier including negative feedback will be

$$G = \frac{AA'}{1 - \beta AA'} \quad (50)$$

Combining Eq. (48), (49), and

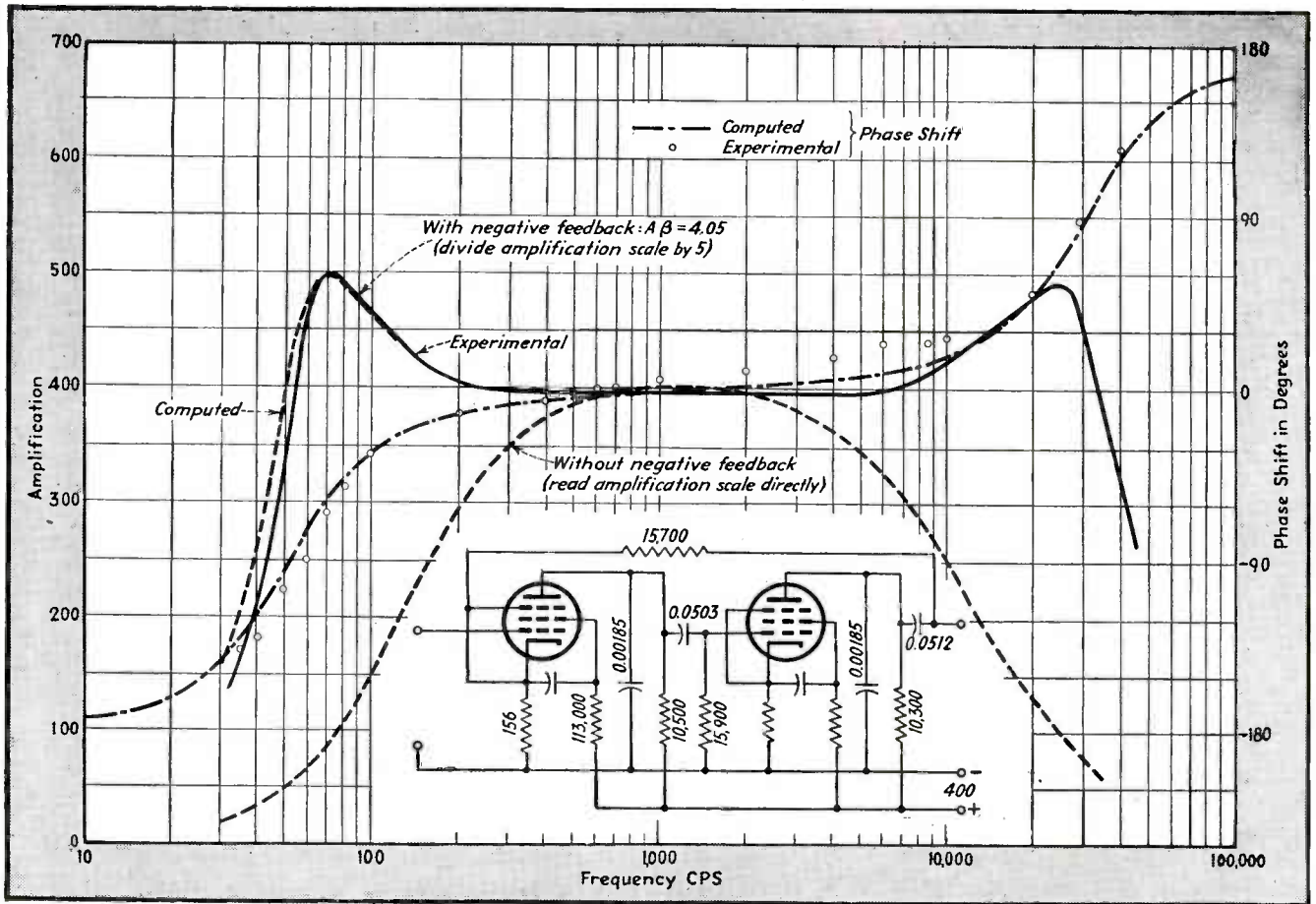

FIG. 15—Magnitude and phase shift of an amplifier from which shunt negative impedance is produced must be known as a function of frequency. The dot-dash curve is phase shift with negative feedback, other curves are gain

(50), the following results, at low frequencies

at low frequencies

$$G = \frac{-A_o A_o'}{\beta A_o A_o' - (1 - jL)(1 - jL')} \quad (51)$$

at high frequencies

$$G = \frac{-A_o A_o'}{\beta A_o A_o' - (1 + jH)(1 + jH')} \quad (52)$$

Also, assume that the second stage is *a* times better than the first, at the low frequencies, and *b* times better at the high frequencies. Or symbolically,

$$a = L'/L$$

$$b = H'/H$$

**Interpretation of Response Equations**

Hence, Eq. (51) and (52) can be written

at low frequencies

$$G = \frac{-A_o A_o'}{\beta A_o A_o' - (1 - jL)(1 - jaL)} \quad (53)$$

at high frequencies

$$G = \frac{-A_o A_o'}{\beta A_o A_o' - (1 + jH)(1 + jbH)} \quad (54)$$

These are vector expressions for

the gain in terms of the frequency variables *L* and *H*. The absolute value of the amplification and phase shift will be found in Table II. If the absolute value of the amplification is differentiated with re-

spect to the frequency variable, it will be found that the frequency response curve of the amplifier has peaks at the low and the high end. Table II summarizes all the pertinent information regarding the re-

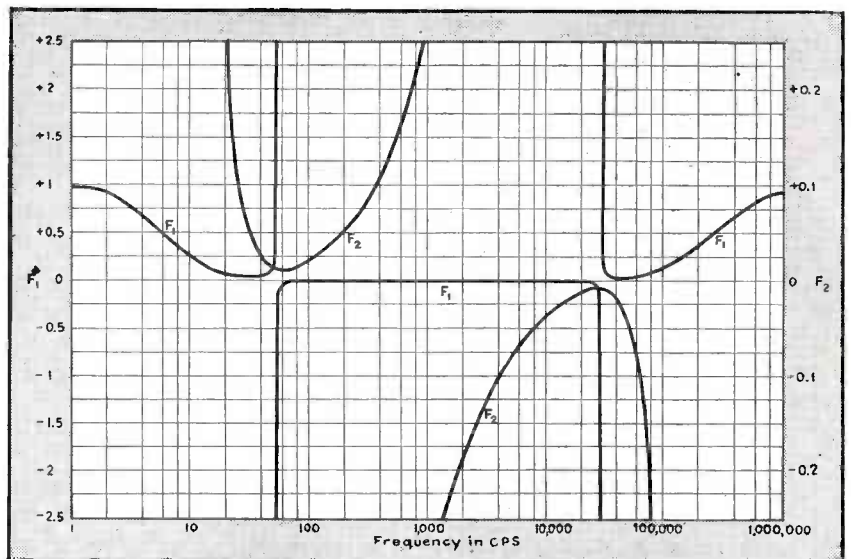
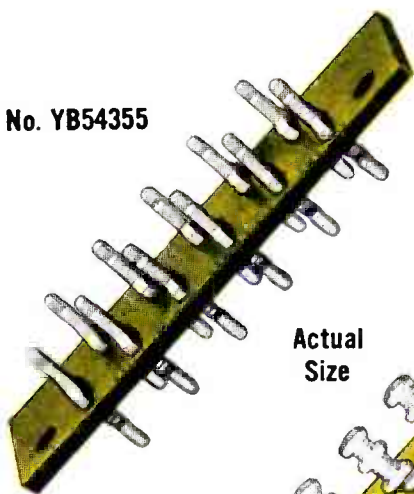

FIG. 16—Variation with frequency of gain functions of the amplifier of Fig. 15

# CINCH

## THRU-LUGS

No. YB54355



Actual  
Size

No. 9023

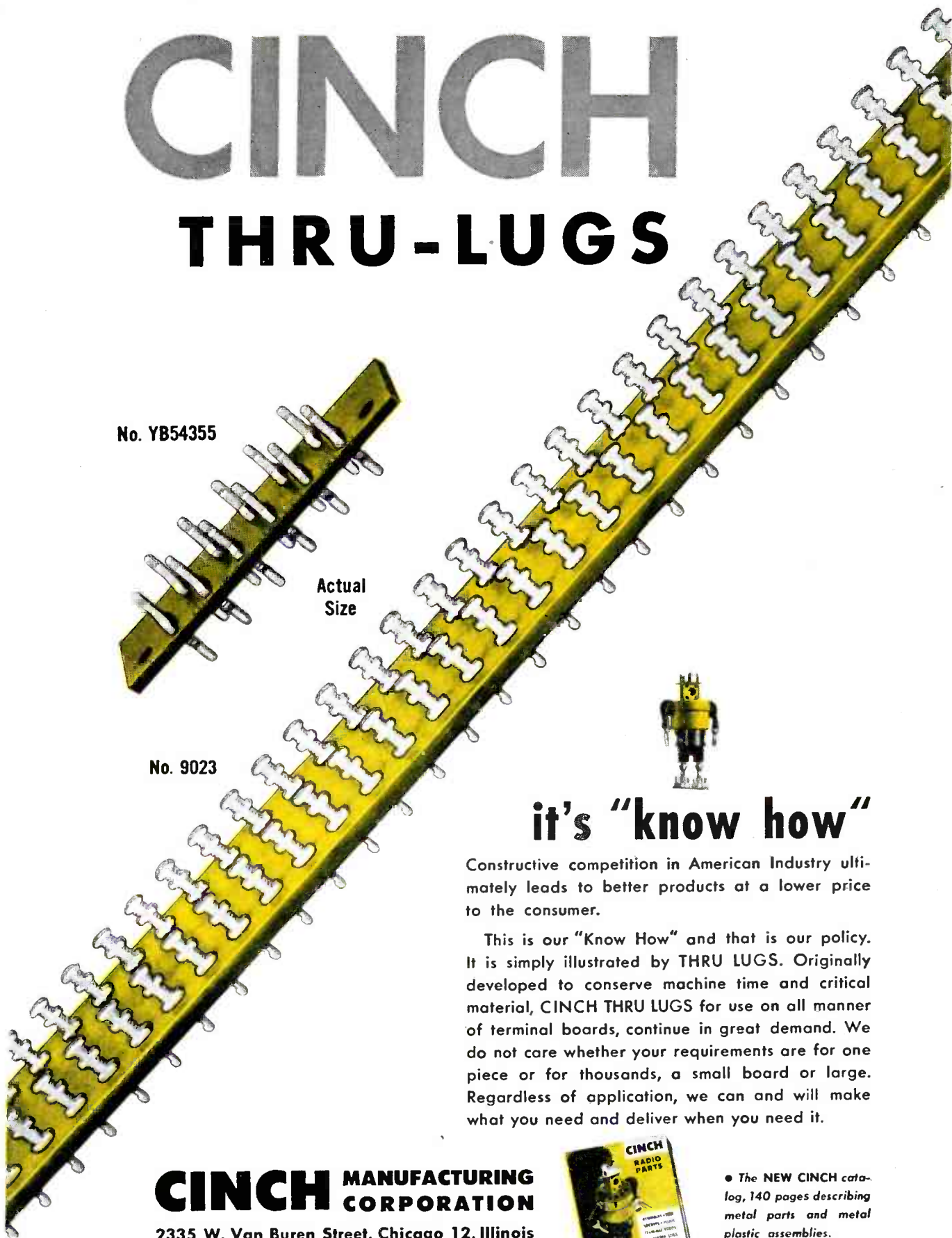

### it's "know how"

Constructive competition in American Industry ultimately leads to better products at a lower price to the consumer.

This is our "Know How" and that is our policy. It is simply illustrated by THRU LUGS. Originally developed to conserve machine time and critical material, CINCH THRU LUGS for use on all manner of terminal boards, continue in great demand. We do not care whether your requirements are for one piece or for thousands, a small board or large. Regardless of application, we can and will make what you need and deliver when you need it.

## CINCH MANUFACTURING CORPORATION

2335 W. Van Buren Street, Chicago 12, Illinois  
Subsidiary of United-Carr Fastener Corp., Cambridge, Mass.



• The NEW CINCH catalog, 140 pages describing metal parts and metal plastic assemblies.

response characteristics of the negative-feedback amplifier of the type shown in Fig. 19. Figure 15 shows a typical response curve of the feedback amplifier.

### Output Impedance of Amplifier

Negative impedances obtained by feedback amplifiers invariably contain a term due to the output impedance of the amplifier. If the amplifier is not stabilized by negative feedback, the output impedance  $R_1$  consists only of the parallel combination of  $R_{o1}$  and  $R_o$  in the mid-frequency range, and is affected by the coupling capacitance  $C_o$  at the low frequencies and by  $C_s$  at the high frequencies. Thus, even in the simplest possible case the output impedance is a function of frequency and is not at all constant.

When negative feedback is utilized in the amplifier, the picture becomes more complicated. As is well known, the effect of voltage feedback is to reduce the output impedance of the amplifier in the frequency range where the phase shift in the amplifier is negligible. But if phase shift in the amplifier is not neglected, there will be frequency regions where the output impedance is increased.

### Effect of Feedback

Roughly speaking, output impedance of the amplifier is affected by three factors. First, if no feedback

is used  $R_o$ , the physical output impedance, is a function of frequency as explained above. Secondly, in the presence of negative feedback in the amplifier, the output impedance is reduced in the mid-frequency range, but when the amplification begins to fall, the output impedance will be increased because (due to phase shift) the negative feedback will actually become positive. Thirdly, due to the coupling between the two stages, the amplification will be zero at the extreme frequency regions, the feedback effects will disappear and the output impedance will be governed by the physical output impedances.

From this it is evident that the problem of determining the output impedance of an amplifier is not simple and the exact expression must depend not only upon the

TABLE I  
Resistive Component of Negative Reactance

Frequency Region	Resistive Component	
Shunt Produced Negative Reactance		
	$Z_2 = j\omega L_2$	$Z_3 = 1/j\omega C_2$
low	-	+
high	+	-
Series Produced Negative Reactance		
	$Z_3 = j\omega L_3$	$Z_3 = 1/j\omega C_3$
low	+	-
high	-	+

characteristics of output elements but also upon the coupling between the two stages. It is possible to analyze the output impedance of an amplifier completely in the general case where the two stages of the amplifier are different. However, the results obtained from such an analysis are so complicated that they become of little actual value and it is simpler to handle each amplifier separately. But to show the type of results that can be expected due to the various effects, a special case will be considered where the two stages of the amplifier are alike in their frequency response. While the relative magnitudes of the various effects will be different for an amplifier with dissimilar stages, the general picture will be the same. Effects due to common power-supply impedance, additional phase shift due to cathode and screen by-passing will be entirely neglected because, by proper design, they can be eliminated.

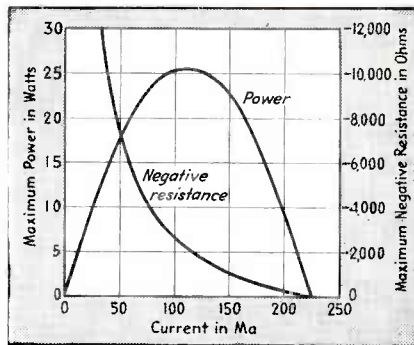

FIG. 18—For a given amplifier there is a limit to the power that can be developed by each value of negative resistance so produced

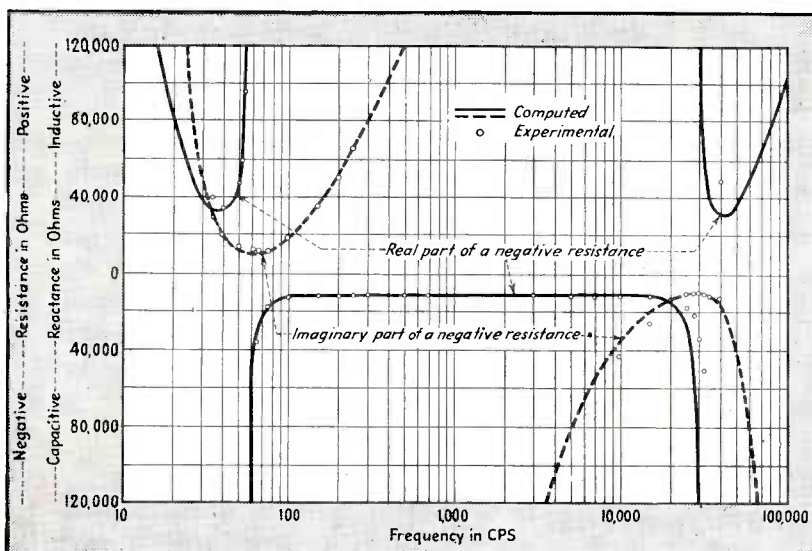

FIG. 17—Real and imaginary components of shunt negative resistance produced by the amplifier of Fig. 15

### Calculation of Output Impedance

The output impedance of an amplifier without negative feedback may be defined as the impedance looking into the terminals 1 - 2 in Fig. 19 with the first tube of the amplifier disconnected. It will be noticed that the resistances  $R_k + R_T$  are in parallel with resistance  $G_{o1}'$ . Resistance  $R_T$  will ordinarily be so high that it will not shunt  $R_{o1}'$  appreciably, but if it does then  $R_{o1}'$  must be corrected.

at low frequencies

$$R_o = \frac{R_{o1}'(R_c' - jX_c')}{R_{o1}' + R_c' - jX_c'} \quad (55)$$

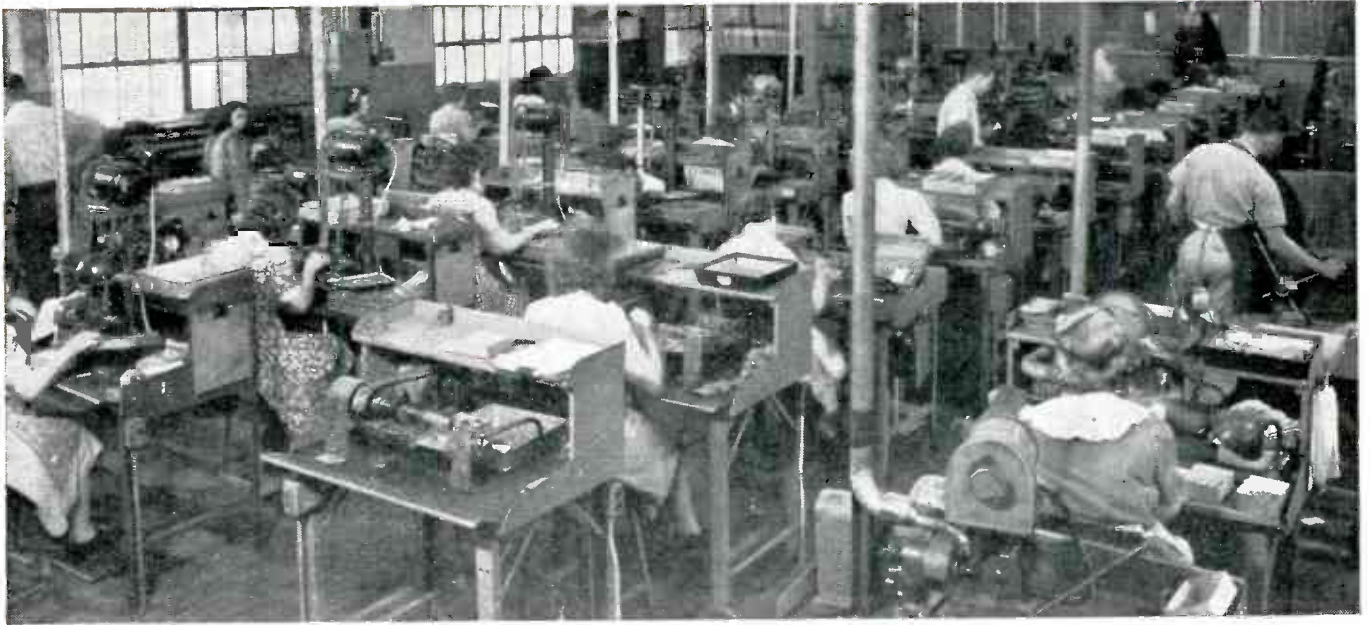

## Precision Workmanship + Engineering Know-How =CONTACT PERFORMANCE

THE constant factor in this equation is Mallory—known as Contact Headquarters by manufacturers of relays, industrial controls, business machines, domestic appliances, circuit breakers and other electrical and electronic equipment.

Precision workmanship at Mallory results from the experience which skilled men and women have gained in working with precious metals and special alloys. For instance, depending on the method most suitable for a specific assembly, they can torch, furnace, induction or resistance braze, silver solder, spot projection or flash weld, spin, rivet or stake contacts to supporting members.

Mallory engineers and metallurgists have 22 years of accumulated "know-how" in designing contacts and contact assemblies and in developing special materials such as Elkonium\* and Elkonite\*. They have created more than 5000 designs for individual contacts and complete assemblies.

Before your electrical or electronic equipment designs are blueprinted, consult Mallory engineers about contacts. Facilities are available for big production or small orders covering contact assemblies, individual contacts, or contacts joined to studs, springs, arms or brackets furnished by you.

P. R. MALLORY & CO., Inc., INDIANAPOLIS 6, INDIANA

\*Reg. U. S. Pat. Off. for electric contacting elements.



P. R. MALLORY & CO. Inc.

# MALLORY

**ELECTRICAL CONTACTS AND CONTACT ASSEMBLIES**

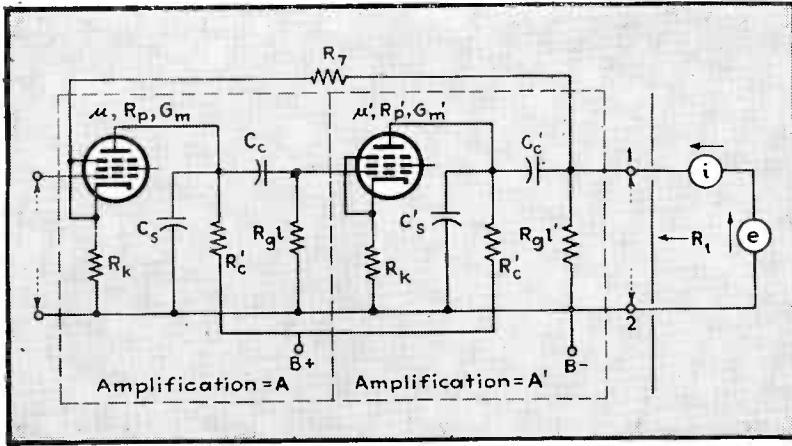

FIG. 19—Typical negative-feedback amplifier the frequency response of which must be known in order to predict the negative impedance that it will produce as a function of frequency

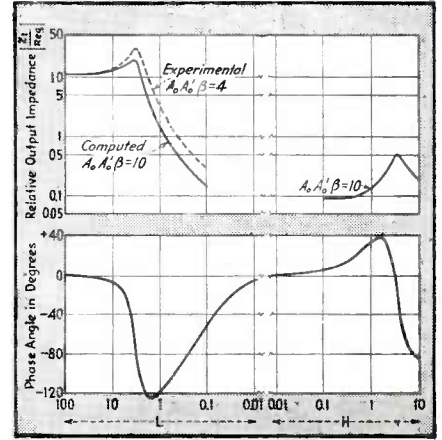

FIG. 20—Variation of amplifier output impedance with frequency affects the magnitude and angle of negative impedance

at high frequencies

$$R_o = \frac{-jX_s'R_c'R_{g1'}}{R_c'R_{g1}' - jX_s'R_c' - jX_s'R_{g1}'} \quad (56)$$

If the impedance  $R_o$  is measured by means of the voltmeter-ammeter method with current supplied from an infinite impedance source, then the following relations are true. The current  $i$  flowing through the impedance  $R_o$  produces a voltage drop  $iR_o$ . A fraction  $\beta$  of this voltage, determined by the ratio  $R_k/(R_k + R_o)$ , appears between the grid and cathode of the first tube and is amplified by the amplifier and forces a current to flow in the impedance  $R_o$  in the opposite direction to the current flowing due to the source of voltage  $e$ . Thus, the conventional feedback equation may be written  $e = iR_o - iR_o \beta AA'$ .

If this equation is solved for  $e/i$ , which is  $R_o$ , and values of  $R_o$ ,  $A$  and  $A'$  are substituted into it, the output impedance of the amplifier is obtained as a function of frequency. For comparison with measurements it is convenient to express the results in polar form, giving the mag-

nitude and phase of the amplifier output impedance.

The nature of the impedance variations given by such equations

is shown in Fig. 20 which gives computed and experimental curves for the output impedance of a typical amplifier.

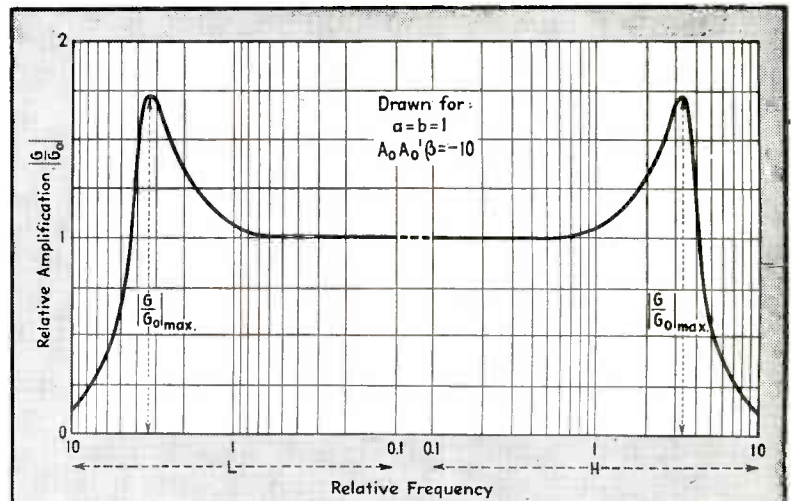

TABLE II  
Frequency response characteristics of a two stage resistance-capacitance coupled amplifier with negative feedback

	Low Frequencies	High Frequencies
Frequency variable	$L = \frac{1}{2\pi f C_c R}$	$H = 2\pi f C_s R_{eq}$
Vector amplification $G$	$\frac{A_0 A_0'}{\beta A_0 A_0' - (1-jL)(1-ja)}$	$\frac{A_0 A_0'}{\beta A_0 A_0' - (1+jH)(1+hb)}$
Phase shift	$-\tan^{-1} \frac{L(1+a)}{aL^2 - (1-\beta A_0 A_0')}$	$\tan^{-1} \frac{H(1+b)}{bH^2 - (1-\beta A_0 A_0')}$
Absolute magnitude $ G $	$\frac{A_0 A_0'}{\sqrt{(\beta A_0 A_0' - 1 + aL^2)^2 + L^2(1+a)^2}}$	$\frac{A_0 A_0'}{\sqrt{(\beta A_0 A_0' - 1 + bH^2)^2 + H^2(1+b)^2}}$
$G_0$	$\frac{A_0 A_0'}{1 - \beta A_0 A_0'}$	
$\frac{ G }{ G_0 }$	$\frac{1}{\sqrt{\left(\frac{aL^2}{1-\beta A_0 A_0'} - 1\right)^2 + L^2 \left(\frac{1+a}{1-\beta A_0 A_0'}\right)^2}}$	$\frac{1}{\sqrt{\left(\frac{bH^2}{1-\beta A_0 A_0'} - 1\right)^2 + H^2 \left(\frac{1+b}{1-\beta A_0 A_0'}\right)^2}}$
Peaks occur at	$L_0 = \frac{1}{2a} \sqrt{4a(1-\beta A_0 A_0') - 2(1+a)^2}$	$H_0 = \frac{1}{2b} \sqrt{4b(1-\beta A_0 A_0') - 2(1+b)^2}$
$\frac{ G }{ G_0 }_{max}$	$\frac{1-\beta A_0 A_0'}{\sqrt{\left(\frac{1+a}{a}\right)^2 (1-\beta A_0 A_0') - \frac{(1+a)^4}{4a^2}}}$	$\frac{1-\beta A_0 A_0'}{\sqrt{\left(\frac{1+b}{b}\right)^2 (1-\beta A_0 A_0') - \frac{(1+b)^4}{4b^2}}}$

#### REFERENCES

- (11) Terman, F. E., Hewlett, W. R., Palmer, C. W., and Wen-Yuan Pan, Calculations and Design of Resistance-Coupled Amplifiers Using Pentode Tubes. A. I. E. E. Technical Paper 40-52. Dec. 1939.
- (12) Terman, F. E., "Radio Engineering," 2nd ed., McGraw-Hill Book Co., Inc., New York, 1937.
- (13) Sturm, T., Verfahren zur Klirrvorminderung (linearisierung), Funktechnische Monatshefte, Mar. 1937, pp. 77-82.



# YOUR CHECK LIST OF NEW IRC PRODUCTS

To a line of resistors already broader than that of any other manufacturer in the entire resistor industry, IRC has, in the last few months, announced several new and important contributions. Among the newer developments having wide-spread application in the electronics field are the components here briefly

reviewed. All of these products are available in reasonable quantities except the Type BTR Resistor, which is still wholly allocated to a special war project. However, samples of this unit are available and will be gladly sent for test or experimental purposes. Your inquiries will receive prompt and welcome attention.

## TYPE PRT POWER RHEOSTAT

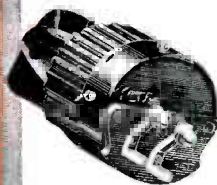

Rugged yet light in weight and of neat appearance the PRT conforms fully with AN3155 specs. Has heavy screw type terminals at rear of enclosed all-metal housing. Available in 25 and 50 watt models.

## TYPE BTA 1 WATT METALLIZED INSULATED RESISTOR



Pencil-thin, less than  $\frac{3}{4}$ " in length and conservatively rated at one watt the BTA is a quality resistor throughout and meets RC30 specs. Low in operating temperature it has proportionately high wattage dissipation.

## TYPE BTR $\frac{1}{2}$ WATT METALLIZED INSULATED RESISTOR



Scarcely bigger than a bump on a wire (L.  $\frac{13}{32}$ "-Dia.  $\frac{3}{32}$ " ) the BTR  $\frac{1}{2}$ -watt resistor has all the quality characteristics and features that have long made IRC's BT line "Preferred for Performance." Suitable for Army-Navy RC 10 applications. Available postwar.

## TYPE FRW FLAT WIRE WOUND RESISTOR



Efficient as a tubular wire wound, the type FRW has many features that recommend it for limited space use. In 5 standard sizes to comply with JAN-R-26, specs for RW 20, RW 21, RW 22, RW 24 requirements.

## TYPE GRW GRADE 1-CLASS 1 RESISTOR



Thoroughly dependable and of sound construction these completely sealed units meet or surpass every requirement of JAN-R-26 specs. Made in 7 standard sizes with power ratings of 15 to 140 watts and resistance ranges of 0.1 to 63,000 ohms.

## FINGERTIP CONTROL



No bigger round than a nickel and wafer-thin, this control will find many useful applications in the smaller electronic devices. All-inclusive design eliminates the usual knob, shaft and bushing without impairing functional operation.

For more complete, technical information on any of the above IRC products write to Dept. I-H.

# INTERNATIONAL RESISTANCE CO.

401 N. BROAD STREET • PHILADELPHIA 8, PA.



IRC makes more types of resistance units, in more shapes, for more applications, than any other manufacturer in the world.

# INDUSTRIAL CONTROL

Testing Lathe Spindles for Accuracy.....	150
Milling Machine with Built-in Electronic Control.....	150
Radio for Emergency Use in Mining Operations.....	152
Increased Speed for Electronic Recorders.....	152
Penetron Measures Thickness and Density with Gamma Rays.....	154
Electrostatic Deposition of Phosphor Powders.....	184
Vacuum-Tube Anticipator Controls Furnace Temperatures... ..	188
Moulding Sponge Rubber With Dielectric Heating.....	196
Sandpaper Made by Electrostatic Process.....	208

## Testing Lathe Spindles for Accuracy

AN ELECTRONIC MICROMETER which was developed to test the performance of precision lathe spindles was described by G. M. Foley, research engineer of the physics department of Battelle Memorial Institute, Columbus, Ohio, at a meeting of the Chicago section of the American Society of Mechanical Engineers during June. Accuracy of the spindles was previously measured only by the accuracy of the parts made

on the machine using the spindle.

The new micrometer measures very small motions, of the order of 0.000001 inch. It operates without mechanical or electrical contact with the moving spindle and its sensitivity is variable over a wide range of operations.

### *Principle of Operation*

The instrument consists essentially of an oscillator whose fre-

quency is varied by the changes in position of the spindle being measured. The output of this oscillator feeds into a discriminator circuit so that changes in frequency are made visible on the screen of a cathode-ray oscilloscope.

The micrometer is used to magnify by 10,000 times the inaccuracies of the spindle, the visible pattern showing the effects of changes in operating conditions of the spindle while running. It is equally capable of making static measurements on the roundness of the spindle shaft and of the bearings of the spindle, showing the steps which should be taken to produce more precise spindles.

The micrometer has also been used to make a high-speed dilatometer to follow the crystalline changes in steels during rapid heating, and may be suitable for a number of other measuring applications requiring high speed and high sensitivity.

## Milling Machine with Built-in Electronic Control

ELECTRONIC FEED drive for table, cross-slide, and vertical slide (spindle head), is a built-in feature of a new Reed-Prentice vertical milling machine. A centralized pushbutton control station contains all the controlling means of spindle start, stop and jog pushbuttons, dials for feed rate control, pushbutton to energize the electronic units, emergency master stop pushbutton and a function selector switch.

The large photo shows two centralized operating levers, in easy reach of the operator. Facing the machine, the group of controls on the right is for the table and the controls on the left for the slides. Each set consists of an airplane-type half-handwheel and a ball grip lever. This gives an infinitely variable feed rate in either direction. The further the handwheel is moved from center or neutral position, the higher the feed rate becomes. Similar to a servo control, this arrangement allows the operator to move the table or slides with practically no effort. The 5-position grip levers provide feed and rapid traverse in either direction. The feed rate is constant, preselected and controlled by the position of

potentiometers located on the pushbutton station.

The operator can easily set the feed rate by simply adjusting the

potentiometer knobs. This enables him to find the most efficient feed while the cutter is in action.

The table, cross-slide, and verti-

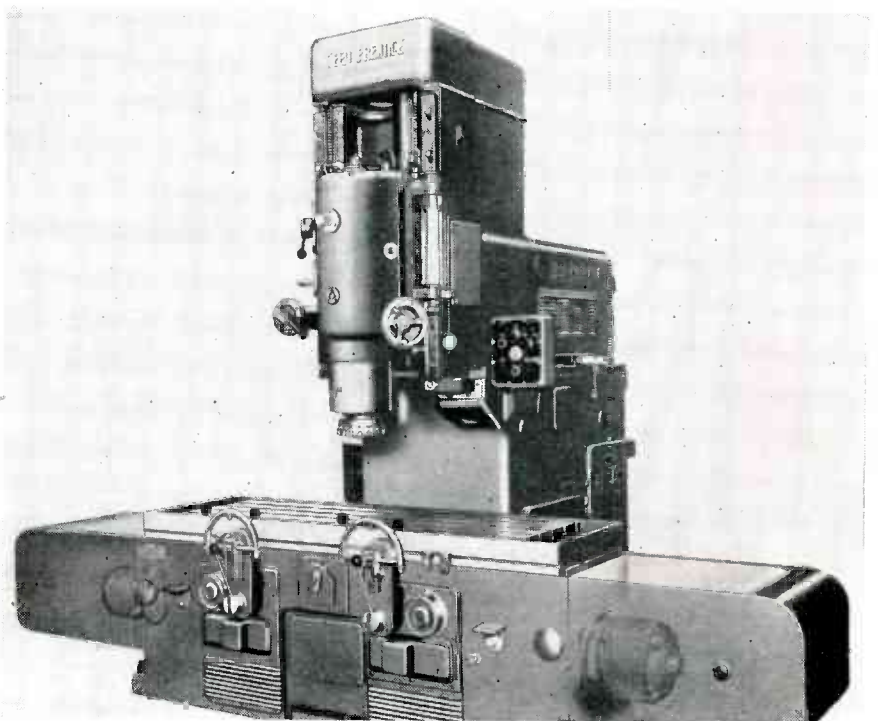

Reed-Prentice vertical milling machine with built-in electronic feed drive. Two electronic units control three motors; one is for the table motor, while the other unit can be switched from the cross-slide to the vertical slide when desired

# REQUIRED READING...

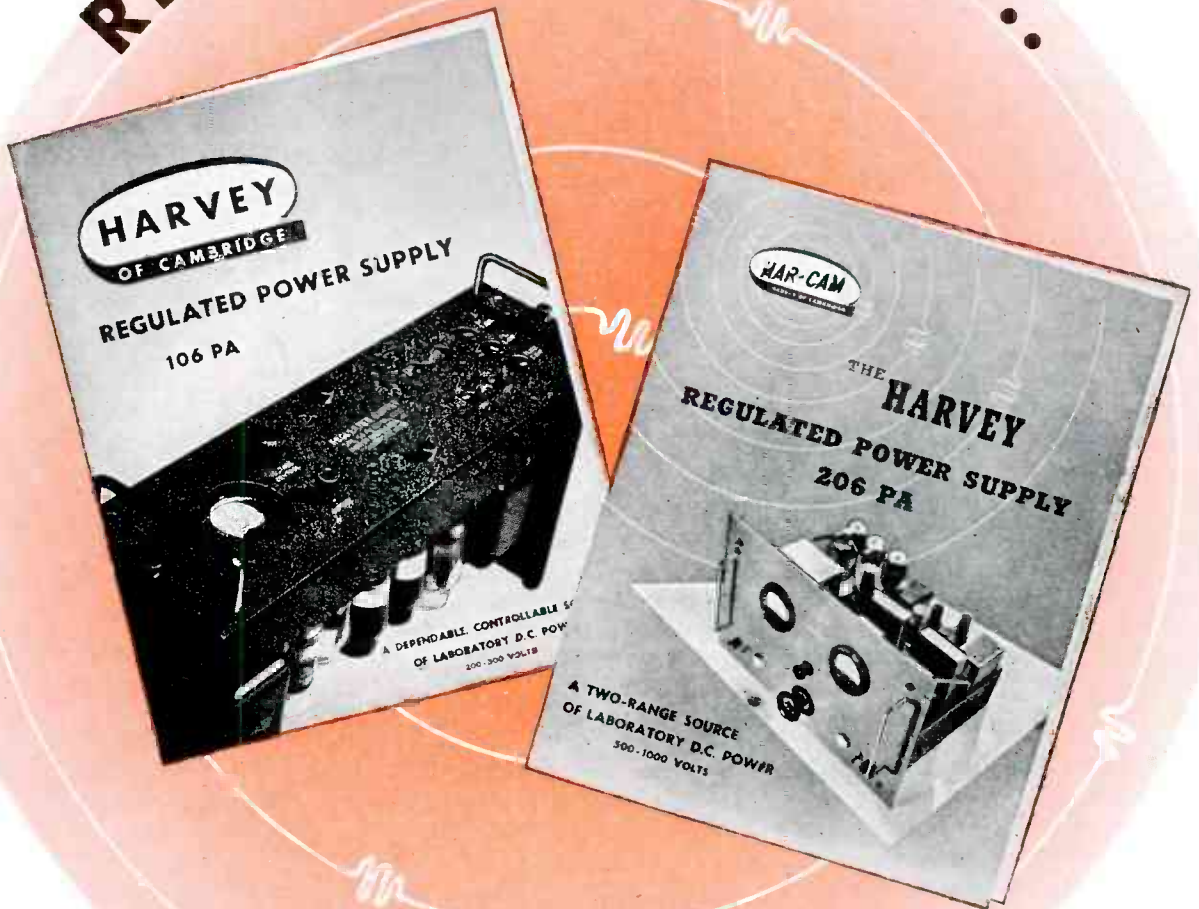

**For Anyone Whose Equipment Includes Amplifiers, Pulse Generators, Measurement Equipment, Constant Frequency Oscillators and Other Apparatus Requiring a Constant Source of Laboratory D. C. Power**

Reading time only ten minutes, but these bulletins will bring you up to the minute on Regulated Power Supply facts and figures.

They contain complete performance and operating information on the Harvey Regulated Power Supply 106 PA and the Harvey 206 PA that are setting new standards of performance and dependability. And they'll show you the design refinements, operating conveniences and precision construction that makes this performance possible.

Whether or not you have an immediate need for a Regulated Power Supply you should have these bulletins in your files. We'll be pleased to forward them to you on request.



**HARVEY RADIO LABORATORIES, INC.**

439 CONCORD AVENUE • CAMBRIDGE 38, MASSACHUSETTS

cal slide (spindle head) are driven by three 1½-hp, d-c motors with electronic control to provide infinitely variable feed rates. The range of the drives is from less than ½ inch to over 25 inches per minute, which corresponds to a ratio of 50:1 or more. The electronic units provide full-wave rectification, armature control for motor speed below 1330 rpm and field control for motor speed above 1330 rpm, reversing, overload and undervoltage protection, armature voltage drop compensation to maintain speed within close limits regardless of load fluctuation, and dynamic brake stop from any speed to prevent coasting.

There are two electronic units for the control of the three motors—one unit for the table motor and the other one for the cross-slide and vertical slide (spindle head) motors. Shift of the latter unit from one motor to the other one is accomplished by means of a selector switch mounted on the pushbutton

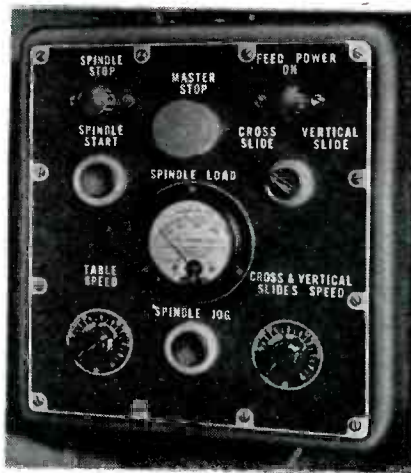

Panel of the centralized control station of the vertical milling machine. The metal case of this unit is dust-tight so a blower is used to circulate air within the box

control station. The electronic units are mounted on a hinged panel and enclosed in a sheet-metal box of dust-tight type. A blower is mounted inside the box for continuous air circulation.

## Radio for Emergency Use in Mining Operation

IN THE COLORADO ROCKIES, Telluride Mines, Inc. operate two hydroelectric generating plants, which supply most of their power requirements. Instant dispatching between any hydro-power house and its water source six miles away is imperative. Telephone systems usually provide adequate communication but such systems have an inherent disadvantage; they can only operate when wires are intact.

Rock slides or snow avalanches 30 feet high sometimes rip out entire sections of telephone line. The situation is further aggravated by the fact that Telluride's Blue Lake Reservoir lies at 12,200 feet in the San Miguel Range. Tapping the bottom is a 1,610-foot tunnel thru solid rock. From here a 2-mile welded steel penstock drops to the first power house where the water pressure is 800 lb per square inch. The average annual snowfall at Blue Lake is 45 feet, making regular winter inspection patrol impossible. Because of the high pressure in the penstock, leaks are cut out and enlarged as though an acetylene torch had been on the job, unless the inlet water valve at Blue Lake is quickly turned off.

Otherwise the penstock may be damaged and the reservoir dissipated.

### Use for Radio

Tests with General Electric equipment proved to the mine operators that two-way f-m radio to supplement the telephone facilities would provide emergency protection.

Station W2XCI was hauled by



Dashboard controls of the two-way f-m installation in the station wagon which operated on the floor of Pandora Basin, Colorado. Fred Deetken, G-E electronics engineer, checks reception

pack horse to Blue Lake at 12,200 feet elevation. W2XCH was left in its own station wagon to operate on the floor of Pandora Basin at Telluride, Colorado. Both W2XCI and W2XCH operate on an assigned experimental channel of 35.46 Mc with 60 watts of carrier power. These were the same veteran sets used successfully in tests conducted by GE for the Denver & Rio Grande Western Railroad.

In the Telluride demonstration, a severe thunder storm, followed by a Rocky Mountain blizzard, occurred during the tests. Reception was clear and strong and no light-

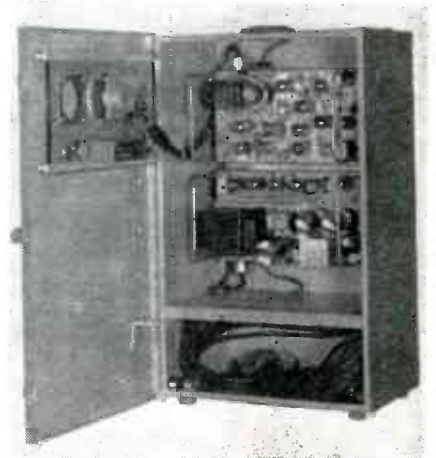

At the Telluride Mines, General Electric f-m equipment was used for communicating between a hydroelectric generating plant and its water source six miles away. A 60-w transmitter of the type used in the experiments is shown above

ning interference or snow static came thru the speakers. The line of sight discrepancy between the station wagon (9,020 feet) and W2XCI at Blue Lake (12,200 feet) was about 2,500 feet due to intervening mountains. This proved no barrier to successful communication because of a slight bending and multiple reflection of the f-m waves. Radio communication was proved practical—even in rugged mountain terrain.

## Increased Speed for Electronic Recorders

INCREASED INDUSTRIAL USE of electronic recorders has been made possible by stepping up chart speeds of Elektronik pyro-potentiometers. The standard speed electronic recorders, single or multiple point

# Announcing LINDSAY Struc-Lok

MODERN METHOD OF SNAP  
ASSEMBLY OF LIGHT SHEET  
METAL PRODUCTS

—by the makers of Lindsay Structure

Recently developed by Lindsay and Lindsay to complement Lindsay Structure, Struc-Lok extends the advantages of preformed metal structures into the field of lightweight construction. A new, simplified method of snap assembling sheet metal products, SL meets the need for smaller and lighter cabinets and housings than are built from Lindsay Structure.

SL consists of only three basic parts—framing, panel sheets, and fittings. Once snapped together, they form a rigid, permanent construction. No bolts, screws, trimming, fitting, welding, or riveting are necessary for SL's assembly—making it excellent for line production.

Available in 24- and 26-gauge steel and in 61ST aluminum, SL will soon be obtainable in copper and other alloys as well. Adaptable to any conventional design, SL readily incorporates openings, louvers, doors, and similar construction details. The sturdy framing supports shelving, hooks, machinery, and equipment without requiring additional struts or braces, and proves ideal for cabinets and housings for electrical and electronic apparatus. Write for information. Lindsay and Lindsay, 222-D W. Adams St., Chicago 6, Illinois; 60 E. 42nd St., New York 17, New York; Lindsay Structure (Canada) Ltd., Dominion Square Bldg., Montreal.

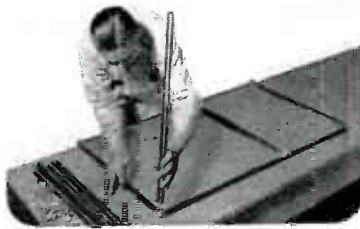

NO BOLTS



NO SCREWS

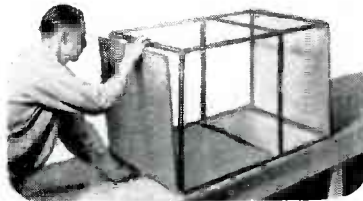

NO RIVETS

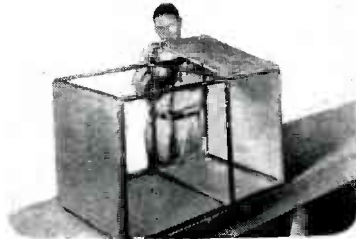

NO WELDS



NO TRIMMING



NO FITTING



Basic Parts for SL

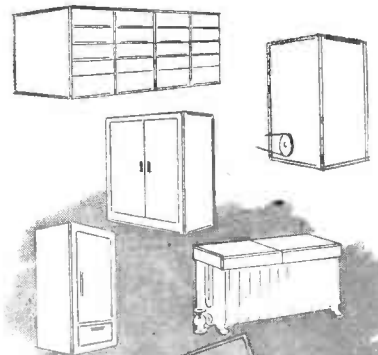

Write for bulletin.

## LINDSAY Struc-Lok

U. S. Patents 2364083 and 2377702—  
U. S. and Foreign Patents and Patents Pending

models, incorporate gear changes for speeds of 5, 10, 15 and 20 inches an hour, it has been announced by Brown Instrument Company.

As shown in the accompanying illustration, the gears are changed by removing screw C from gears

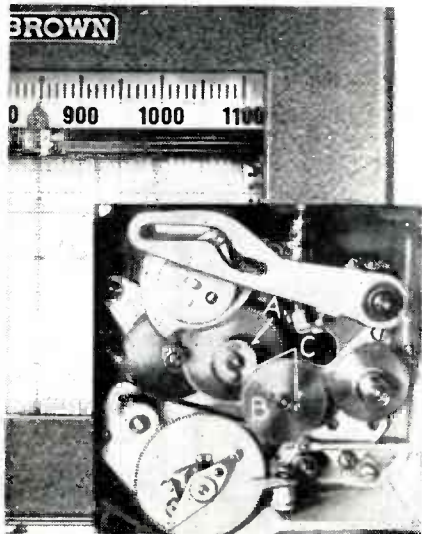

Gears A and B, shown above, can be replaced by new gears for faster operation of the Brown recorder

A and B and by lifting the gears from the assembly. The new speed gears are then installed and screw C is replaced.

Fast speed electronic models, single or multiple point, will have internally mounted gears that provide speeds of 10, 20, 30 and 40 inches an hour.

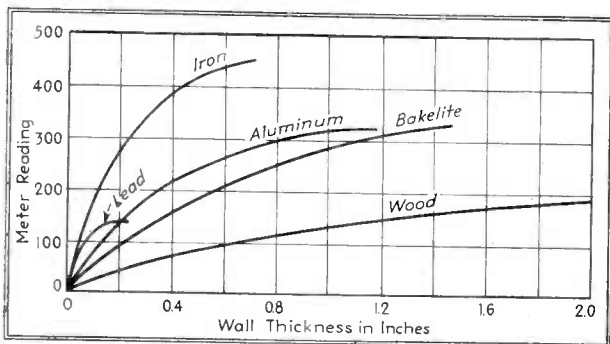

Typical calibration curves for flat plates of various materials. The maximum measurable thickness for a given material is that at which further increases in thickness do not affect the meter reading

Wall thickness measurements (in hundredths of an inch) made from the outside of a large surge drum, with contour lines drawn through points of equal thickness. Smallest contour loops show severe erosion of wall material

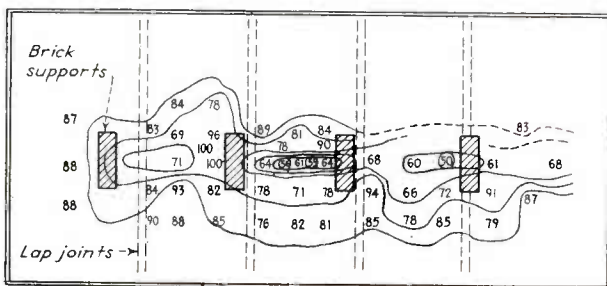

## Penetron Measures Thickness and Density with Gamma Rays

SECRECY has recently been lifted by the government on a new device utilizing electronic and radioactivity principles for the measurement of thickness of solids, metallic or non-metallic, and for determining liquid level and liquid density. This device, called the Penetron, need only be held against one side of a wall to obtain an accurate measure of wall thickness or an indication of the nature and level of the liquid or material on the other side of the wall.

### Principle of Operation

In operation the instrument bombards material with gamma rays which are derived from a needle containing one milligram of radium in the form of a commercially available salt. These gamma rays travel with the velocity of light and are, in fact, radiant energy. They are not deflected by magnetic or electrical fields. Some of these rays are back-scattered by the electrons of the atoms in the material being inspected, so that they emerge from the material on the same side as they entered. The intensity of the back-scattered radiation increases as a direct function of the thickness of the material at the spot being measured. By measuring the intensity of this back-scattered radiation, the thickness of the material, whether it be steel, aluminum,

plastic, brass, wood, or any other substance, can be obtained with extreme accuracy. By the same means, liquid levels and liquid densities are also obtained.

The radium source is surrounded with a shield containing a window which directs the beam of gamma rays in the desired direction. The thickness and design of the shield were arrived at after a careful study of the allowable dosages of gamma rays to which the average individual may be exposed without any physiological effects.

In order that the measurement of back-scattered radiation may be made with a high degree of accuracy, it is necessary to set up the source of radiation, the wall and the detector in accordance with a pre-determined geometric arrangement. A metal shield is positioned between the radioactive source and the radiation detector to prevent direct radiation from entering the detector.

The radiation picked up by the detector creates current discharges which are amplified and integrated to produce a direct current. The amount of current produced is measured by a microammeter.

### Calibration Curves

In order to convert the reading of the microammeter into wall thickness in inches, the instrument is calibrated on specimens of tubing and flat plates having known wall thicknesses. Because the geometrical relationship between the measuring head and the wall changes with the curvature of the wall, it is to be expected that the calibration curves for a wall of a given composition will vary depending on the diameter or curvature of the wall or vessel being measured, and on whether the measurements of curved surfaces are made from the outside or from the inside.

Calibration curves have to be established only once and are furnished with the instrument. The curves are not affected by small changes in the chemical composition of the material comprising the wall. For example, the calibration curves for iron also apply to alloyed steels.

Wall thickness measurements can



**—Your Microphone is here**

As outstanding manufacturers of microphones for war —Shure offers a complete microphone line. You will find the proper microphone for every need above. A complete description of any model will be furnished upon request.

- |                                     |                           |
|-------------------------------------|---------------------------|
| A. Super-Cardioid Broadcast Dynamic | G. Lapel Microphone       |
| B. Unidyne Cardioid Dynamic         | H. Military Carbon        |
| C. Uniplex Cardioid Crystal         | I. Throat Microphone      |
| D. Stratoliner Dynamic              | J. Carbon Hand Microphone |
| E. Laboratory Non-Directional       | K. Mask Microphone        |
| F. "Economy" Crystal                | L. Stethophone            |
|                                     | M. Vibration Pick-up      |



**SHURE BROTHERS**

*Designers and Manufacturers of Microphones and Accustic Devices*

225 West Huron Street

Chicago 10, Illinois

ENGINEERS! DRAFTSMEN! ACCOUNTANTS! STUDENTS!

**ORDER TODAY! Sensational NEW**

# MULTI Slide Rule

WITH **8** ADDITIONAL, EXCLUSIVE TABLES!  
NOW FIGURE ANYTHING... WITH ONE RULE!

**\$1**  
(Obtainable only from Stancor Jobber in your area)

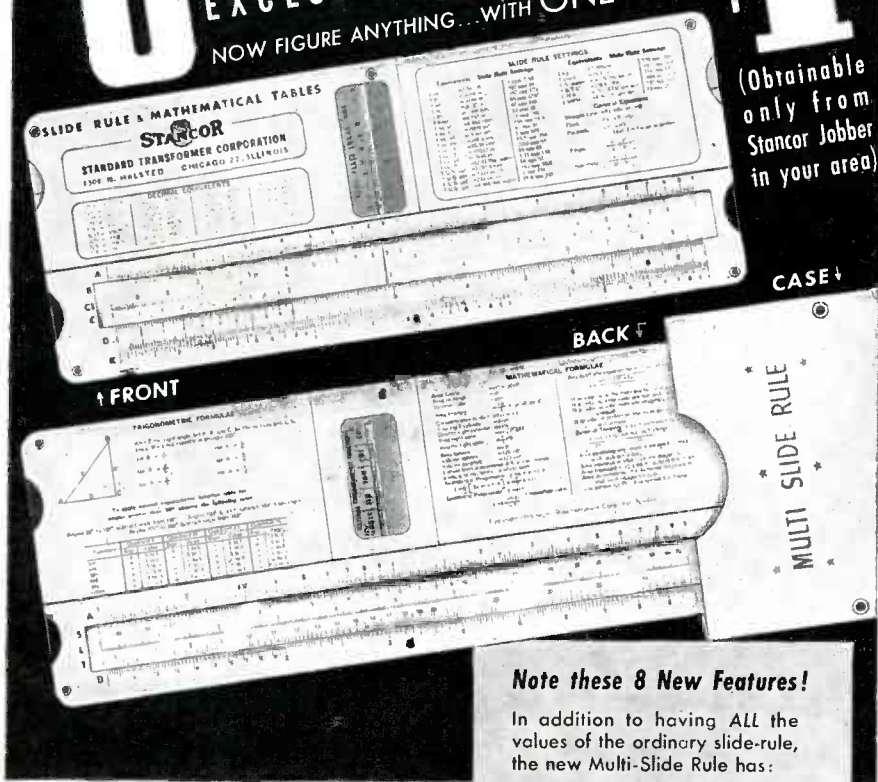

Clear, legible print... Tough, durable for long wear... Size 10" x 4"... Fits 3-ring binder... In case... Full instructions... **TRANSPARENT PLASTIC INDICATOR...**

STANCOR now offers the entire electronic industry the new Multi-Slide Rule. First developed for our own use, it is today made available to all... Greatly simplifies calculation of unlimited range of problems... A genuine professional rule—not a toy. This rule is obtainable **ONLY THROUGH STANCOR JOBBERS. PLEASE DO NOT ORDER DIRECT.** See your local directory for the name of the Stancor jobber in your city or, write for his name. Price of Stancor Multi-Slide Rule: One Dollar!—America's biggest slide-rule bargain—a service to the trade by Stancor.

STANDARD TRANSFORMER CORPORATION  
1500 N. HALSTED ST. CHICAGO 22, ILL.

**Note these 8 New Features!**

In addition to having ALL the values of the ordinary slide-rule, the new Multi-Slide Rule has:

- 1** Four-place LOGARITHM TABLE
- 2** SIGNS and LIMITS of VALUE assumed by trigonometric functions
- 3** Table of NATURAL TRIGONOMETRIC FUNCTIONS
- 4** Table of TRIGONOMETRIC FORMULAE
- 5** Table of SLIDE-RULE SETTINGS
- 6** Table of GENERAL EQUATIONS
- 7** Long list of common MATHEMATICAL FORMULAE
- 8** DECIMAL equivalents of a fraction

OFFERED AS A SERVICE TO THE TRADE BY

# STANCOR

**ORDER FROM YOUR JOBBER**

PENETRON

(continued)

be made on pipes or vessels which contain fluids, provided a correction is made to take into account the influence of the fluid on the reading of the instrument. The magnitude of this correction is dependent upon the density of the fluid, but for practical purposes the necessary correction can be made simply by establishing a calibration curve for pipes of known wall thickness filled with the same fluid.

With any electronic equipment, failures of tubes, capacitors and other parts are to be expected. In

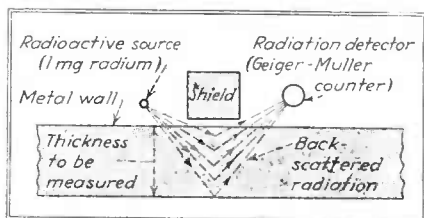

Operating principle of the Penetron, a new radioactive instrument for measuring the thickness of a wall when only one side of the wall is accessible

order to detect such failures, a set of concentric half-round steel shells and a calibration curve for these standard shells are supplied with the instrument. By measuring the thickness of the standard shells, the operation and overall performance of the instrument may be checked quickly at any time. Equipment failures of any type will be reflected by a deviation from the standard calibration curve.

*Measuring Limits and Accuracy*

In general, calibration curves for the instrument have a rather steep slope for the smaller wall thicknesses but tend to flatten out with increasing wall thickness. The thickness at which flattening of the curve starts is the limit for accurate measurements. The accompanying calibration curves show that the Penetron can be used for measuring iron or steel walls up to approximately 0.75 inch thickness. For other materials the limit is different, being approximately one inch for aluminum. This limitation is due to the fact that the penetrative power of deflected or scattered gamma rays is less than that of the primary rays and rays which are deflected beyond a certain depth are



# PLAY SAFE BY PLANNING FASTENINGS EARLY IN PRODUCT DESIGN STAGE



"Cold-forging" — proof #28  
... more each month

## 3 Standard Fastenings for Production Efficiency



**1 Phillips Recessed Head Screws**—The modern, effective, time-saving fastening device proven in tens of thousands of assembly lines. Other standard head styles are also available.



**2 Self-Tapping Machine Screws**—Eliminate separate tapping operations for fastenings to castings, heavy gauge sheet metal, and plastics. Also available with Phillips Recessed Head.



**3 Washer-Screw Assemblies**—When use of lock washers is indicated, the time-saving of pre-assemblies is obvious. Also available in standard slotted head styles.

It's our business to help you play safe by assisting you in the design or selection of the proper "all important" fastenings for your product. By making that decision early, while your product is still in the design stage, you can prepare ahead for the fast and precise assembly job essential to your product's success.

Our broad experience in fastenings and our demonstrated ability in special design makes Scovill your logical choice. We will recommend the best modern fastening for your specific need—a featured standard fastening, or a part requiring our ingenuity in special design and cold-forging such as illustrated by the special purpose item shown above. Our special processing of this part, too, meant substantial savings in money—materials—motions.

Call our Fastenings Expert to serve you . . . and profit by our demonstrated Scovill ability in standard or special design and cold-forging. Call *Today*.

# SCOVILL MANUFACTURING COMPANY

## WATERVILLE SCREW PRODUCTS DIVISION

WATERVILLE 48, CONN.



TEL. WATERBURY 3-3151

NEW YORK, Chrysler Building • DETROIT, 714 Fisher Building • CHICAGO, 135 South LaSalle Street • PHILADELPHIA, 18 W. Chelton Avenue Building  
PITTSBURGH, 2882 W. Liberty Ave. • SYRACUSE, Syracuse • Kemper Insurance Bldg. • LOS ANGELES, 2627 S. Soto St. • SAN FRANCISCO, 434 Brannan St.

It's brimming with

transformer facts



Often electronic designers can pick exactly the transformer they want from our new catalog, "Transformers for Electronic Equipment."

This 32-page book is full of easy-to-read, descriptive information, tabular data, and large, full-color photographs of representative, hermetically sealed, compound-filled, and core-and-coil transformers and reactors. The 600 ratings listed cover power transformers (plate- and plate-and-filament units), filament transformers (conventional and high-voltage types), and reactors (microphone, plate, conventional or swinging filter, and modulation units). Audio-frequency transformers, built to your specifications, include microphone, input, interstage (or grid), modulation, and output types. Write for Bulletin GEA-4280.

Now — small capacitors with

glass terminal seals

A distinct advance in small capacitor construction is the use of glass terminal seals of unique design, in which the glass is fused to the metal in an impervious bond. Capacitors built with these new glass seals effectively resist fungus, humidity, and thermal shock, and pass the proposed JAN-C-25 temperature and immersion cycling tests with a wide margin of safety. Terminals are solder-dipped brass, for easy connection.

At present, G-E capacitors with glass terminal seals are available in case styles CP-60, -62, and -64, in all ratings covered by proposed specification JAN-C-25, for use in combat communications equipment where severe operating conditions may be encountered. Write for Bulletin GEA-4424.

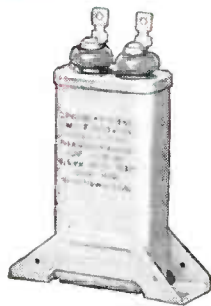

Relays that can

really take it

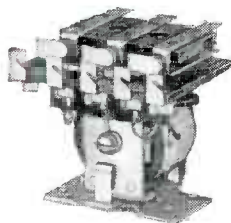

Even at 50,000 feet, when many relays begin to arc, G-E aircraft relays, mounted in any position, give sea-level performance. Balanced armature construction assures that contacts will remain open or closed, though subjected to

mechanical vibration between 5 and 55 cycles and amplitudes to 1/32 in. (1/16 in. total travel), or linear acceleration to 10g in any direction.

These corrosion-proof relays operate in ambient temperatures from minus 70 F to plus 200 F, and are available in one-, two-, three-, and four-pole, sensitive and time-delay types. For operation at either 12 or 24 volts d-c. Special-purpose relays, and a type for 500- and 1000-volt d-c operation are available.

Remote controls that

go around together

For remote control and indicating applications with single or multiple receivers, G-E selsyns stay synchronized. When a receiving selsyn gets out of step, current flows in the secondary, and the resultant torque pulls the receiver back into synchronism.

Differential selsyns, installed between the transmitter and receiver, allow the receiver to lead or trail the transmitter by a fixed or variable number of degrees.

For precision applications, the high-accuracy selsyn (standard in three sizes) is dependable to plus or minus one degree without external load. Where accuracy of response need not be closer than plus or minus five degrees, general-purpose selsyns (four standard sizes) provide lower-cost indication and remote control. Torque output varies with the size in both types.

Accuracy values are for 60-cycle, 110-volt operation. Write for Bulletin GEA-2176A.



GENERAL  ELECTRIC

# DIGEST

## Timely Highlights on G-E Components

### Tells when it's time to re-tube



G-E time meters, Type KT, keep an accurate record of hours of tube use; tell you when it is time to replace tubes.

Driven by precise Telechron motors, G-E time meters are supplied to register in either hours, tenths of hours, or minutes, and for operation on 25-, 50-, or 60-cycle a-c, at 11, 115, 230, or 460 volts. Available in round or square cases for panel mounting, round cases for conduit mounting, and as a portable unit for intermittent checking and laboratory use. Write for Bulletin GEA-3299.

### How to Kill radio noise

Particularly effective in the band frequencies from 200 kilocycles to 20 megacycles, G-E pi-type filters are especially suited to suppressing radio noises caused by generators, dynamotors, inverters, and similar equipment used on aircraft. Rated 25, 100, and 200 amperes at 50 volts, d-c, they comply with the requirements of U.S.A.A.F. Specifications No. 32331-A.

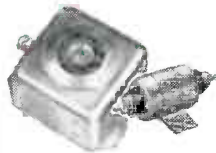

Where economy calls for lower-cost filtering, the G-E thru-stud capacitor provides effective filtering from 200 kilocycles up to 38 megacycles with attenuation characteristics far superior to those of conventional capacitors. Weighs only 4½ ounces. Write for Bulletins GEA-4098A and GEA-4308.

### Just "8 bits" big

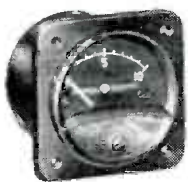

These new 1½-inch G-E panel instruments, just the diameter of a silver dollar, are less than an inch deep and weigh only three ounces. Yet they incorporate all the desirable features associated with the unique G-E internal-pivot construction, and are accurate to within plus or minus 2 per cent.

Fast response and high resistance to vibration are two of the advantages of this instrument's high torque and light-weight moving element, while good damping makes reading both easy and accurate.

Supplied for direct-current, radio-frequency, and audio-frequency service, in both watertight and conventional cases. Write for Bulletin GEA-4380.



Capacitors • Sensitive control and time-delay relays • Limit switches • Motors, dynamotors, amplidyne • Motor-generator sets • Alnico magnets • Small panel instruments • Formex<sup>®</sup> magnet wire • Radio transformers • Switchettes • Selsyns • Chokes • also tubes, crystals, plastics products, insulation materials, and many others

General Electric Company  
App. Dept., Sec. 642-8  
Schenectady 5, N. Y.

Please send me:

..... GEA-4280

..... GEA-4424

..... Data on relays

..... GEA-2176A

..... GEA-3299

..... GEA-4093

..... GEA-4098A

and -4308

Note: more data available in Sweets' File for Product Designers

NAME .....

COMPANY .....

ADDRESS .....

CITY .....

STATE .....

8010



# Use ONE Self-locking PALNUT Instead of Two-Piece Fastenings

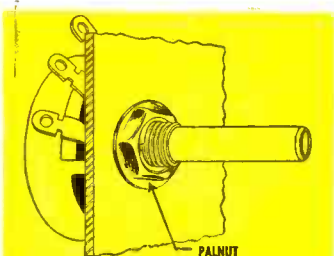

A Self-locking PALNUT Type WT replaced more expensive jam nut and lockwasher on this volume control, saving in cost of material and labor.

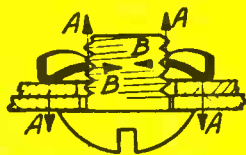

**\* DOUBLE LOCKING ACTION**

Arched, slotted jaws grip the bolt like a chuck (B-B), while spring tension is exerted upward on the bolt thread and downward on the part (A-A), securely locking both.

By using a self-locking PALNUT in place of a regular nut and lockwasher, you cut the cost of fastenings in half and reduce assembly time 50%. At the same time, the PALNUT double locking action\* keeps parts tight under vibration.

Self-locking PALNUTS are especially adapted to fast moving assembly lines, because they apply speedily with power drivers or Yankee drivers. Fit into same space as hex nuts. PALNUTS are single thread, spring tempered steel locknuts, requiring only 3 screw threads. Very low in cost. Available in a wide range of types, sizes, finishes and materials.

Send details of assembly for samples. Write for Palnut Manual No. 2, giving data on principle, advantages, application, types, sizes, etc.

The Palnut Co. 77 Cordier St., Irvington 11, N.J.

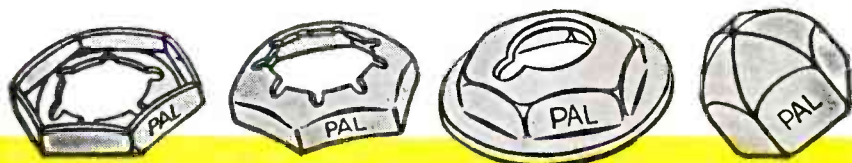

# Self-Locking PALNUTS

completely absorbed before reaching the surface as back-scattered radiation. Only thin sheets of lead, up to about 0.1 inch thick, can be measured accurately because the high atomic number of lead approaches that of radium and entirely different effects take place.

The accuracy of the instrument has been established by conducting hundreds of experiments with specimens of unknown wall thickness. After determining the thickness by means of the Penetron, the specimens were drilled and calipered mechanically. By this method the Penetron has been established to have an accuracy within plus or minus 3 percent.

The Penetron measures the average thickness over an area of approximately one square inch. For this reason, it cannot be used for the detection of cracks, pin-holes, or pin-hole type corrosion, nor can

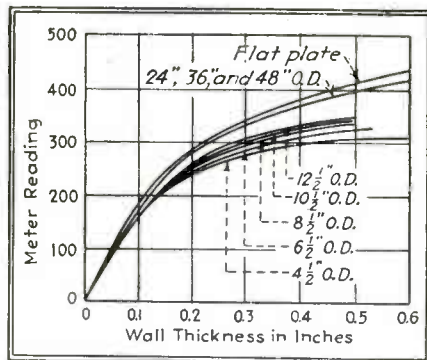

Calibration curves for outside measurements on iron plates and iron tubing

it differentiate between the component layers of laminated construction. It measures the total thickness or volume and not the thickness of any one layer. If, however, a laminated wall is composed of, say, two layers of different materials, the Penetron can be used to measure the thickness of either layer provided the thickness of the other layer is known. In this case the thickness of the unknown layer is determined as the difference between the total thickness and the thickness of the known layer.

150 Measurements per Day

The individual pulses of current created in the detector do not follow each other at regular intervals because the rate of emission of

it's new!

SARAN

braid

for better electrical insulation

resists

rot,

oil,

moisture,

abrasion,

heat,

cold

Cable and wire braid with insulating qualities far superior to any other material—that's the stimulating news brought by this announcement of Saran braid. It marks an important advance in wire protection and provides long-sought answers to many troublesome problems.

Here is a braid that resists abrasion—Saran is permanently tough and durable. It is fungus and mildew proof—long life is the rule even under adverse service conditions. And, more important to the electrical industry, Saran defies moisture and oil—enemies that attack, and soon rot, ordinary cable coverings.

These better insulating properties point to the use of Saran in myriad applications\* extending all the way from simple extension cords to intricate wires in radio and radar. If you would like to know more about its value to you, write for further details.

*Let's work it out together*

Success in plastics is not a one-man nor even a one-industry job. It calls for the cooperation and combined skill of manufacturer or designer plus fabricator plus raw materials producer. Working together, this team saves time and money and puts plastics to work successfully. Call us—we'll do our part.

**PRESENT AND POTENTIAL USES:**\* Braided covering for wire and cable of all kinds. Especially valuable in guarding against abrasion in such applications as extension cords, etc. Many uses for cable such as household appliance cord that is exposed to moisture and consequent rendering of shock. Resistant to rot caused by entrapped moisture or oil in such applications as automotive wiring.

**PROPERTIES:** Combines toughness with flexibility even at temperature extremes. Flexural strength, p.s.i. 15,000 to 17,000. Highly resistant to broad range of chemicals. Water absorption less than 0.1. Nonflammable. Excellent electrical insulator. Not subject to distortion of flow at contact points. Available in many colors. Softening point 240°-280° F.

**THE DOW CHEMICAL COMPANY • MIDLAND, MICHIGAN**

New York • Boston • Philadelphia • Washington • Cleveland • Detroit  
Chicago • St. Louis • Houston • San Francisco • Los Angeles • Seattle



**PLASTICS**

STYRON • STYRALOY • ETHOCEL • ETHOCEL SHEETING  
SARAN • SARAN FILM • STRIPCOAT

**USE STANDARD PARTS—SAVE TIME AND MONEY**

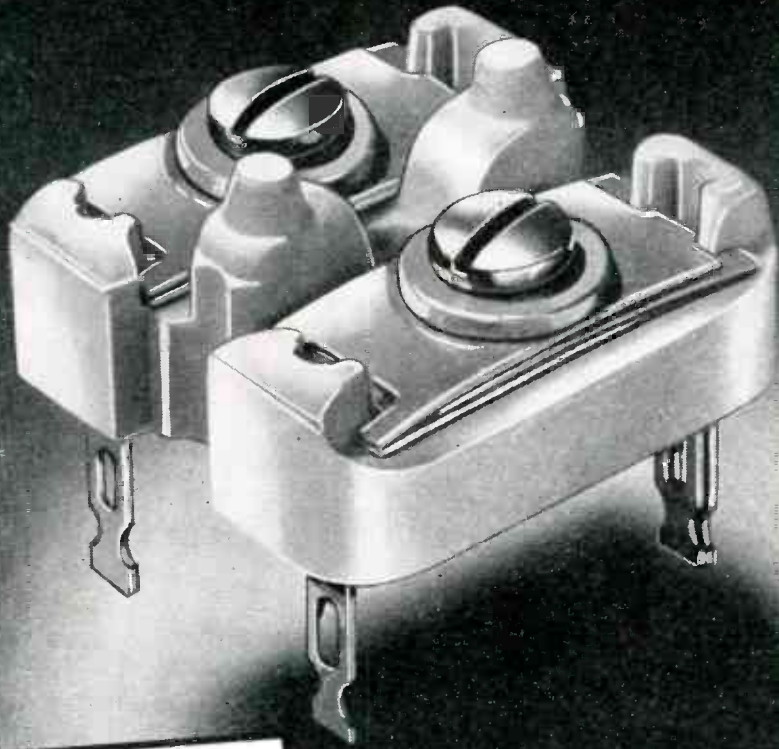

**READY**

*In 1941, Automatic was ready.  
We have produced millions of units  
for our fighting forces.*

*In 1945, Automatic is ready - -  
We are still mass-production minded -  
Order your coils and trimmers  
from people who "know how".*



**AUTOMATIC**  
**MANUFACTURING**  
CORPORATION

**MASS PRODUCTION COILS & MICA TRIMMER CONDENSERS**

900 PASSAIC AVE.

EAST NEWARK, N. J.

## ...and they lived happily thereafter

### the story of a SHOTGUN WEDDING!

The Electrical Industry just had to have insulating tapes and sheets which would withstand the rigors of extreme dielectric, extreme heat and extreme moisture and have great mechanical strength despite extreme thinness in order to meet the specs for space and weight . . . and so with the pressure on

#### FIBERGLAS and MICA WERE JOINED IN UNION

and the progeny of the "blending" are happily at work, promoting efficiency throughout the electrical industry where prior to the "marriage" let-downs frequently occurred.

Mica, as is well known, while one of the most satisfactory materials for electrical insulation because of its high dielectric, high compression strength and high heat resistance, is weak mechanically since it must be used in the form of built-up splittings of very fine film.

In order to take advantage of the insulating values of Mica and to overcome its mechanical deficiencies a reinforcement was found to be necessary. Fiberglas, with its great mechanical strength, its high temperature, dielectric and excellent moisture resistance proved to be the ideal reinforcement for Mica Splittings.

The products of this union—Fiberglas-Mica-Combinations—have all the desired qualities to combat severe service hazards; great mechanical strength, non-stretch, no need to varnish, available in any thickness from .010 to 35 mils, resist temperatures beyond 150° C., and extremely high dielectric.

Write for Bulletin HC 2-1, it tells the entire story of Fiberglas-Mica-Combinations . . . and for Quick Deliveries PHONE—WIRE—or—WRITE

MFG-0 made with 3-mil Fiberglas on only one surface of the Mica. Available in overall thicknesses ranging from 10 to 20 mils inclusive  
MFG-1 made with 3-mil Fiberglas on both surfaces of the Mica. Available in overall thicknesses ranging from 10 to 25 mils inclusive  
MFG-2 made with 3-mil Fiberglas on one surface of the Mica, but with 12-mil Fiberglas on the other side. Available in overall thicknesses ranging from 20 to 35 mils inclusive  
MFG-3 made by bonding 1-mil paper to one surface of the Mica and 3-mil Fiberglas to the other. Available in two overall thicknesses—6 and 8 mils approximately  
MFG-4 made with one surface of 1-mil paper and with 7-mil Fiberglas on the opposite side of the Mica. Available in overall thicknesses of 10, 12 and 15 mils  
MFG-5 made with 3-mil Fiberglas on one surface of the Mica, but with 15-mil Fiberglas on the other side. Available in thicknesses ranging from 25 to 35 mils, inclusive.

**MITCHELL-RAND**  
for 56 YEARS  
THE ELECTRICAL  
INSULATION  
HEADQUARTERS

EST. 1889

**MITCHELL-RAND INSULATION COMPANY, INC.**  
51 MURRAY STREET Cortlandt 7-9264 NEW YORK 7, N.Y.

Fiberglas Varnished Tape and Cloth  
Insulating Papers and Twines  
Cable Filling and Pothead Compounds  
Friction Tape and Splice  
Transformer Compounds

A PARTIAL LIST OF M-R PRODUCTS  
Fiberglas Saturated Sleeving, Varnished Tubing  
Asbestos Sleeving and Tape  
Varnished Cambric Cloth and Tape  
Mica Plate, Tape, Paper, Cloth, Tubing

Fiberglas Braided Sleeving  
Cotton Tapes, Webbing and Sleeving  
Impregnated Varnish Tubing  
Insulating Varnishes of all types  
Extruded Plastic Tubing

Joint Army-Navy R93 Specification  
**COMPARATIVE  
 DATA**

TYPE  
 1196

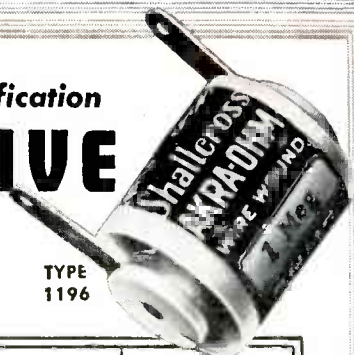

JAN Style Numbers RB	JAN Power Ratings Watts	Shallcross Type Numbers	Shallcross Power Ratings Watts
RB10	0.25	173 176*	0.25 0.25
RB11	1/3	183 183-A 186*	0.5 0.5 0.5
RB12	0.5	193*	1.0
RB13	0.5	196 1196**	1.0 1.0
RB14	1.0 1.0	116 1110**	2.0 2.0
RB20	0.75	100	1.0
RB21	Suggest JAN 20 or JAN 22		
RB22	1.5	110	2.0
RB40	0.4	120	0.25
RB41	0.5	140	0.5
RB42	0.6	160	1.0
RB51	0.25	181-A	0.5

NOTE: \* Indicates Maximum JAN Dimensions.  
 \*\* Indicates Hermetically Sealed Resistor.

gamma rays by radium is quite irregular. The emission follows certain statistical laws and fluctuates around an average value. The accuracy with which this average value can be determined experimentally increases as the time of observation is increased. Considerations along these lines lead to the establishment of a minimum time for any measurement in radioactivity in order to achieve a required accuracy. In the case of the Penetron, the minimum time for each reading is 25 seconds.

Allowing for moving the instrument, set-up time and recording of results, in actual field work it has been found that it is easily possible to make measurements at 150 or more points during a working day.

*Determination of Liquid Level*

The instrument accomplishes its various functions by accurately measuring the amount of back-scattered radiation. If the head of the Penetron is placed on the wall of a vessel partially filled with liquid

**JAN R93 and  
 SHALLCROSS  
 Akra-Ohm**

**Accurate Fixed Wire Wound  
 RESISTOR TYPES**

Write today for Shallcross Resistor Engineering Bulletin R giving full details on Akra-Ohm Resistors for every need and including mounting and terminal designs; dimensions; power dissipation; resistance alloys; moisture and fungus-proofing and hermetic sealing data; temperature coefficient of resistance and maximum resistance charts.

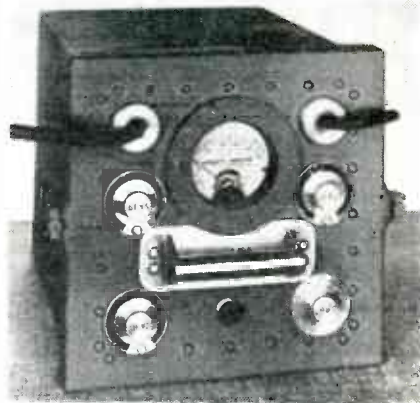

Control box of latest industrial version of the Penetron. The seven-wire cable at the left goes to the detector head, and the other cable goes to any 115-volt, 60-cycle power source

and above the level of the liquid, the amount of back-scattered radiation will be due entirely to the wall of the vessel, since the density of the air or vapor in the vessel is substantially negligible by comparison with the density of the material comprising the wall.

If the head is moved down along the wall of the vessel the reading of the instrument will remain constant until it reaches a point oppo-

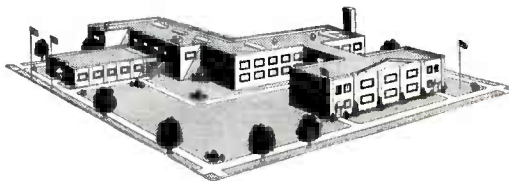

**SHALLCROSS MFG. CO.**

*Engineers • Designers • Manufacturers*

DEPT. E-85, COLLINGDALE, PA.





## **C O N C E N T R I C I T Y . . .**

### **for Minimum Transmission Losses in High Frequency Lines**

SYMMETRY, accuracy of concentricity and proper dimensions of the dielectric, are important factors in the efficient performance of coaxial cables.

The outer conductor consists of a closely woven copper braid which permits maximum flexing without impairment of characteristics.

Anaconda research constantly aims at improved types to keep pace with the rapid progress in this field. Anaconda Coaxial Cables are constructed to fulfill present objectives of electrical designers, and our engineers will gladly cooperate in the development of special models for individual requirements.

40292



#### **ANACONDA COAXIAL CABLES**

Anaconda coaxial cables are made in a variety of types to Army-Navy specifications.



# **ANACONDA WIRE & CABLE COMPANY**

GENERAL OFFICES: 25 Broadway, New York City 4

*Subsidiary of Anaconda Copper Mining Company*

CHICAGO OFFICE: 20 North Wacker Drive 6 • Sales Offices in Principal Cities

# Decentralization of Industry

## ...as a Post-War Policy

Whether it's "sixty million" jobs or some other figure that represents full employment post-war (we hear arguments on both sides of the question) there's a sensible approach to the matter that shines out like a clear light. Sub-contracting, as an industrial principle, will go a long way toward keeping people employed. And sub-contracting will spread the employment throughout the many communities which will feel most cruelly the cut-backs of war production.

### Sub-contracting speeded conversion to war ...it will speed re-conversion to peace

The system of sub-contracting is nothing new—but it took the war to develop its tremendous possibilities in speeding conversion and spreading the work.

The re-conversion to consumer products will call for the same kind of readjustments... readjustments that can be taken in stride more easily by calling on America's war-proven system of sub-contracting.

### Cutting Corners in Tooling-Up

New products, new improvements, new models take time to get into production. But much of that time can be reduced if good sub-contractors are called in.

There's a knack in sub-contracting. It's a business that calls for mental and physical agility. We've been at it for over fifty years. Tooling-up for hundreds of new and different products in a hurry is nothing new to us. We processed over five thousand separate contracts last year alone. It meant tooling-up and setting up assembly lines for an entirely new product an average of once a week.

There are many production corners that can be cut by an adept sub-contractor, that will cut time from your schedule that your engineers may find it hard to believe. There are skills to every trade—ours is sub-contracting. Maybe we've got what you've been looking for.

★ ★ ★

*Write on your business stationery for 48-page book. "Let Lewyt Do It"—the story of the Lewyt organization in pictures. Lewyt Corporation, 60 Broadway, Brooklyn 11, N. Y.*



FOR MORE THAN 50 YEARS A CONTRACT MANUFACTURER... EXPERTLY STAFFED TO PRODUCE COMPLETE ELECTRONIC AND MECHANICAL ASSEMBLIES, COMPONENT PARTS AND SUB-ASSEMBLIES, TO THE MOST EXACTING REQUIREMENTS

CONTINUE BUYING WAR BONDS

**ELECTRONIC GLASS  
BLOWING**

**KNOWLEDGE OF  
ELECTRON BEHAVIOR**

**COME TO MACHLETT  
FOR THE ANSWERS**

**LUBRICATING BEARINGS  
IN A VACUUM**

**WHEELED VACUUM**

**DEVELOPMENT OF  
MALLEABLE BERYLLIUM**

**2,000,000-VOLT  
PRECISION X-RAY TUBE**

**PRECISION ELECTRON  
CONTROL**

**CASTING IN A  
VACUUM**

**PERFECTED OUTGASSING**

**Service • Enthusiasm • Cooperation • Accuracy • Knowledge • Exclusive Features • Research • Consultation**

**The  
complete Machlett  
story includes  
service**

**THESE ARE  
MACHLETT  
TECHNIQUES**

The above ten Machlett techniques reflect only a part of one side of this organization — that of technical capability.

It takes much more than even the highest techniques to make a business great. There is also required a thorough knowledge of customers' requirements, and that conscientious, painstaking, continuing meeting of them called "service."

Just as there is the most intimate relationship between an electron tube and the equipment with which it is connected, so there is a close and constant contact with our customers.

With them we are never in competition, and thus we may be, and often are, called upon to do design and development work, to live with tube and equipment problems, and cooperate in solving them. We often follow through all the way to the ultimate users, to make certain of their satisfaction and see that conditions of use are such as to assure optimum results and economy. It is a long-established Machlett practice not merely to accept but to seek out every opportunity to serve. Thus, Machlett customers obtain much more than the best possible tubes.

When you need a medical or indus-

trial X-ray tube, or a radio or industrial oscillator, amplifier or rectifier, it will pay you to choose a Machlett. Write for information as to available types, identifying the associated equipment and nature of use. Machlett Laboratories, Inc., Springdale, Connecticut.



APPLIES TO RADIO AND INDUSTRIAL USES  
ITS **48** YEARS OF ELECTRON-TUBE EXPERIENCE

QUICK DELIVERY ON LEADING MAKES OF

*Electronic and Electrical*

# POWER SUPPLIES

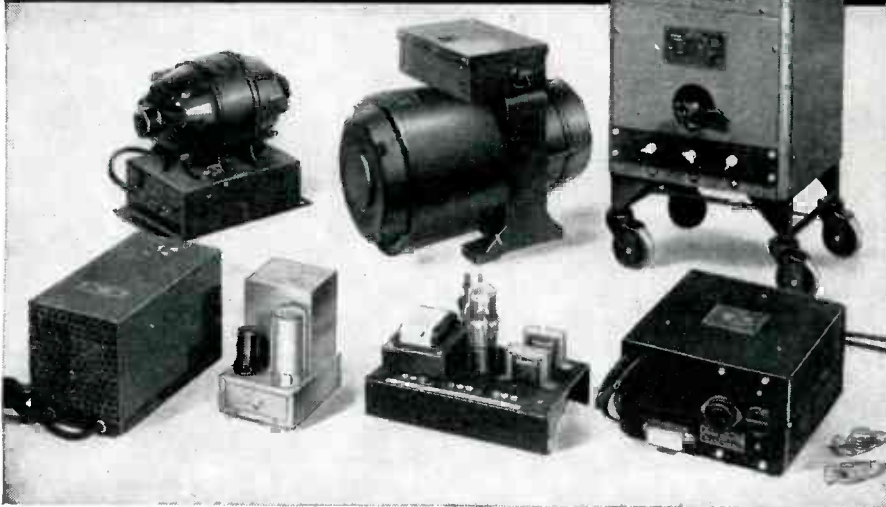

*M*ANY types and makes of power supplies are centralized at ALLIED. This enables government and industry to obtain needed units in the shortest time possible. Quite a few types are on hand for *rush delivery*.

Here you find Low Voltage High Current Supplies for aircraft, battery charging, plating, etc.; Vibrator and Rotary-Type Converters and Inverters for frequency changing and for converting A.C. to D.C. and D.C. to A.C.; Gas-Engine, Wind-Driven, and Motor-Driven Generators; Vibrapacks for mobile operation; Dry Batteries; and general utility Power Supplies. Also Dry Disc, Electronic and Vibrator Rectifiers.

*Save time and work . . . call ALLIED First!  
Use our complete stock and procurement service.*

WRITE, WIRE, OR PHONE HAYMARKET 6800

G.E.  
MALLORY  
ATR  
ELECTRONIC LAB.  
JANETTE  
EICOR  
PIONEER  
KATO  
G.T.C.  
STANCOR  
KNIGHT  
ELECTRO PRODUCTS  
WINDCHARGER

Helpful  
**BUYING  
GUIDE**  
Available  
on Request  
Write for it!

## ALLIED RADIO

CORPORATION

833 W. Jackson Blvd. • Dept. 24-H-5 • Chicago 7, Illinois

SUPPLIERS OF ELECTRONIC PARTS AND EQUIPMENT TO INDUSTRIAL AMERICA  
Electronic Tubes, Rectifiers, Power Supplies, Intercommunicating Systems, Sound Systems, Photo-Cell Equipment, Batteries, Chargers, Converters, Generators, Supplies for Resistance Welders, Fuses, Test Instruments, Meters, Broadcast Station Equipment, Relays, Condensers, Capacitors, Resistors, Rheostats, Transformers, Switches, Coaxial Cable, Wire, Soldering Irons, Microphones, Speakers, Technical Books, etc.

PENETRON

(continued)

site the level of the liquid in the container. At this point, the meter of the instrument will indicate an increase in the amount of back-scattered radiation, due to the fact that the radiation passing through the wall is scattered not only by the wall but also by the liquid in the vessel. By noting the point on the wall of the vessel at which an increase in the reading of the instrument is obtained, it is possible to locate the level of the liquid quite accurately. Likewise, the interface between two fluids of different densities can be located easily and accurately from the outside of a container without actual access to the interior of the container.

By proper instrumentation, the Penetron may be adapted to control as well as to locate liquid levels. In addition, a continuous record of the location of the levels may be ob-

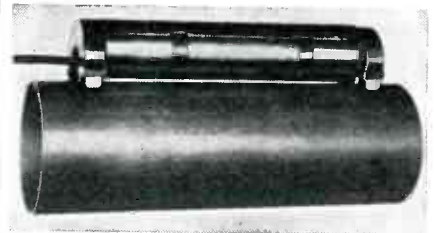

Measuring head in magnet-type holder designed for use on ferrous tubing

tained by employing a recording device. Liquid level measurements which may be made with the Penetron include gaging liquids in storage tanks, gaging liquefied gases in cylinders, controlling levels in process units such as the solvent-oil interface in a solvent refining tower, and determining and controlling the catalyst level in catalyzed chemical reactions.

*Determination of Specific Gravity of Fluids*

All penetrating radiation is to a certain extent scattered or diffusely reflected by the material it traverses and the degree of scattering is a function of the number of electrons encountered by the penetrating rays in their passage through the material. Since the total number of electrons present in a unit volume of any substance is closely related to the density of that substance, it is apparent that the



Investigating the grain structure of a metallurgical subject, magnified 585 times.

## ..... Arming radio for war

MODERN GLOBAL WARFARE has subjected radio communication equipment to hitherto unheard-of forms of punishment. Not the least of these are extremes of shock and vibration, the enormous acceleration of high-powered aircraft take-offs and the abrupt deceleration of carrier landings.

Such service requires not only a high degree of excellence in design and fabrication, but also an infinite amount of research in the field of available materials and their behavior under varying conditions.

Collins chemical and metallurgical research has

played a very important part in developing the Collins communication transmitters and receivers which have proved so trustworthy in Military service. The result of continuing research will be reflected in the Collins equipment available to commercial users after the war. Collins Radio Company, Cedar Rapids, Iowa; 11 West 42nd Street, New York 18, N. Y.



. IN RADIO COMMUNICATIONS, IT'S . . .

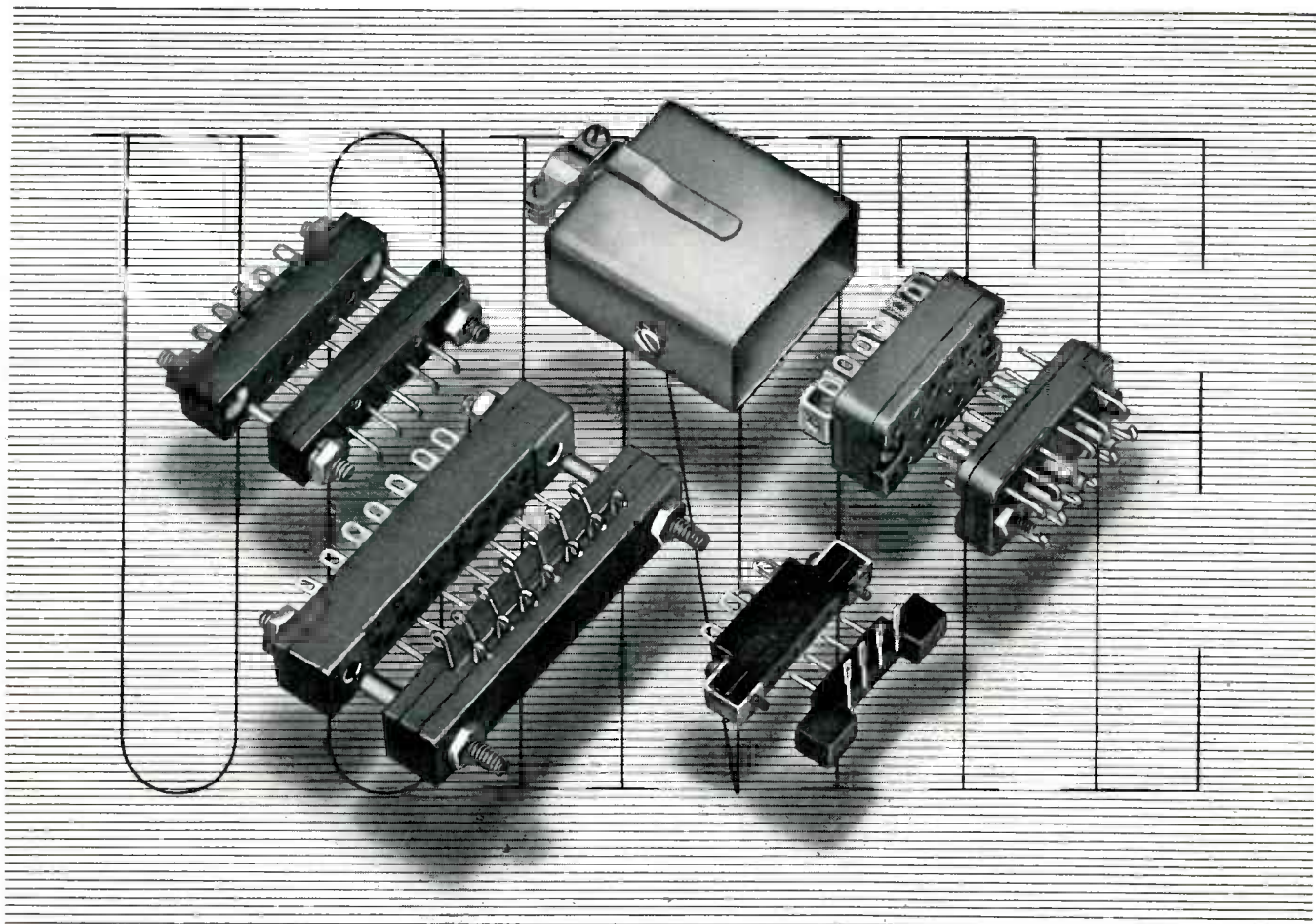

## *4 samples...but simple!*

We are producing quite a variety of these small multiple plugs and receptacles which have been developed for important new uses in the Armed Services. Their special feature is that they make it possible to hook up so many connections in very limited space. Notice that one of them, for instance, packs fifteen connectors and a polarizer into an assembly measuring only  $\frac{1}{2}$ " by  $2\frac{3}{4}$ ".

But these four samples are simple. Later on we will show you some others we make that are much more complicated.

All of them, we believe, have a lot of interesting postwar possibilities.

**The UCINITE CO.**

*Newtonville 60, Mass.*

Division of United-Carr Fastener Corp.

**Specialists in RADIO & ELECTRONICS**

**LAMINATED BAKELITE ASSEMBLIES**

**CERAMIC SOCKETS • BANANA PINS &**

**JACKS • PLUGS • CONNECTORS • ETC.**

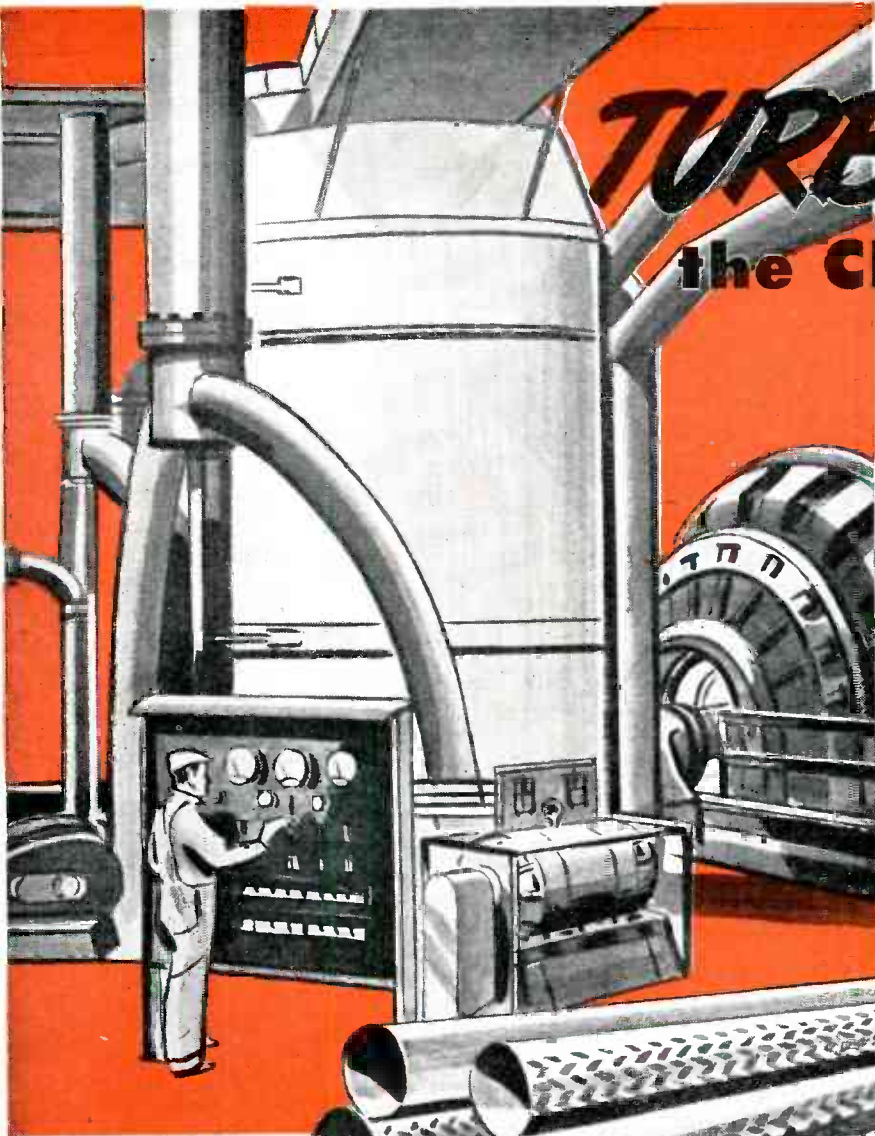

# TURBO majors in the Chemical field

...and sets new standards for electrical insulation efficiency for all industries!

Chemical plants—tough proving grounds for any type of electrical insulation—involve severe deteriorating influences; acids, alkalis, solvents, corrosive fumes, vapor, moisture and humidity are usually encountered. Not to be outdone, wide temperature fluctuations add materially to the hazards of insulation, too.



TURBO Sleeveings—diversified in characteristics—provide solutions to these adversities. They are available in four types to meet specific operating conditions—Extruded Tubing for immunity to sub-zero temperatures; Varnished Glass Tubing for resistance to high heat; Flexible Varnished Oil Tubing for resistance to chemicals, moisture, etc. All feature perfect concentricity and smooth bore for rapid and easy installation.

TURBO Wire Markers, too, are supplied in all sizes, colors and markings. They are easily applied, permanent and simplify maintenance and repair. Write today for the free TURBO Sample Board; specimens and sizes of each type tubing are included.

## WILLIAM BRAND & COMPANY

276 FOURTH AVENUE, NEW YORK 10, N. Y.  
325 W. HURON STREET, CHICAGO 10, ILL.

BLOCK MICA • MICA PLATE AND PRODUCTS • VARNISHED OIL TUBING  
SATURATED SLEEVING • VARNISHED CAMBRIC • CLOTHS AND COMPOSSES

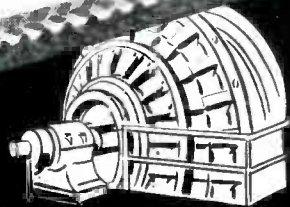

**FLEXIBLE VARNISHED OIL TUBING:** This product finds application where immunity to corrosive fumes, acids, alkalis and solvents is essential. It is impervious to moisture and non-hygroscopic. An important insulation for chemical installation.

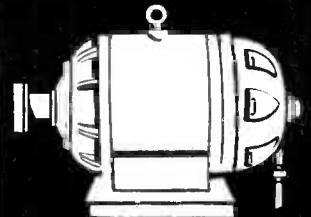

**VARNISHED GLASS TUBING:** An extensively used sleeving, resistant to high temperature. Recommended for heavy duty in confined areas where ventilation is at a minimum. Suitable for enclosed motors and wiring subjected to high heat.

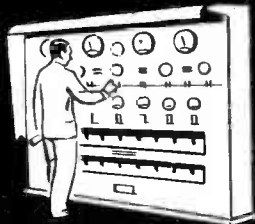

**EXTRUDED TUBING:** This smooth, wall tubing withstands the rigors of severe low temperatures. This immunity to embrittlement at sub-zero cold permits wiring runs adjacent to low temperature equipment, piping, etc. with assurance of dependability.

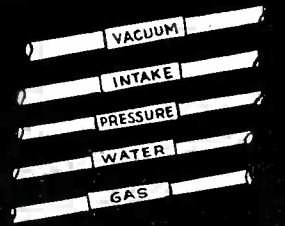

**WIRE IDENTIFICATION MARKERS:** Now available in two types—sleeve and tab. Furnished in any color and marking, they reduce identification and tracing of piping, conduits and cables to an accurate split second procedure.

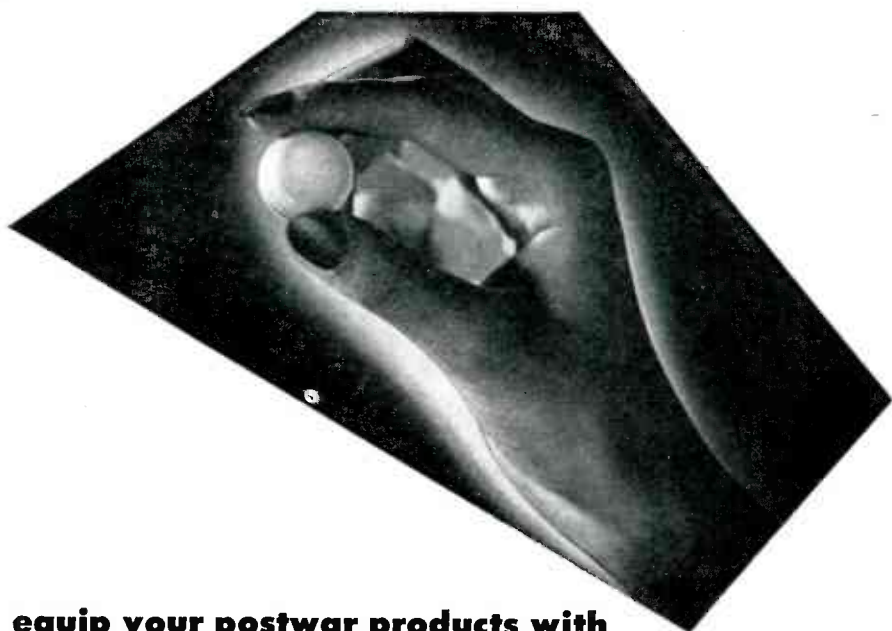

equip your postwar products with

## TELEX MAGNETIC RECEIVERS for "EVERY-SYLLABLE" clarity

Tiny and jewel-like in appearance, Telex Magnetic Receivers are rugged enough to withstand the humid heat of the tropical jungles of New Guinea or the damp, freezing fogs of Kiska. Here Telex Magnetic Receivers received their first baptism of fire under the brutal abuse of roaring, jerking tanks—the abuse of actual combat on the beachheads. Here the clarity and rugged dependability of Telex Magnetic Receivers brought unfailingly the vital messages of battle to the inaccessible outposts of the front line. Of this service to our fighting men, Telex is justifiably proud.

Today . . . drawing upon this wealth of experience Telex engineers continue with new and marked advancement in tiny magnetic receivers. Improvements that set new high standards in high fidelity reception and control of sound communication.

You may need, for your own products, this type of dependable high fidelity receivers. If so, use Telex Magnetic Receivers for any equipment needing high fidelity and absolute clarity under all atmospheric conditions—for any equipment needing the utmost in rugged dependability—for any equipment needing gem-like beauty of magnetic receiver design.

Products such as wearable radios, airplane and airport receivers, IC systems for railways, telephone equipment, modern dictating equipment, medical equipment and all types of sound research equipment are but a few that can be improved by the clarity and dependability of Telex Magnetic Receivers.

Should your postwar needs require the creative ability of Telex engineering research, let Telex help you. Watch Telex for new electronic developments.



FOR EVERY-SYLLABLE CLARITY

# TELEX

ELECTRONIC PRODUCTS DIVISION  
MINNEAPOLIS 1, MINNESOTA

PENETRON

(continued)

amount of scattering per unit volume is largely dependent upon the density of the material. Therefore, as the density of the material increases the amount of back-scattered radiation detected also increases and for practical purposes the Penetron measures density. For this reason, the density of a fluid inside of a container may be determined directly without access to the fluid itself. In experimental work employing a Penetron situated on the outer wall of a container having a wall thickness of 0.3 inch, it was found possible to check the specific gravities of fluids having values of between 10 deg Baume and 75 deg Baume with a high degree of accuracy. This measuring technique can be used advanta-

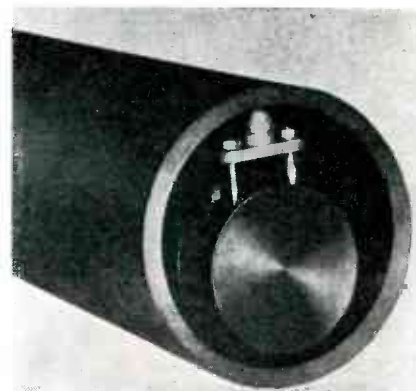

Measuring head used with hydraulic-type holder for inside measurements of tubing, made when the outside is inaccessible

geously only for determining specific gravity of liquids in tankage, routing the flow of oil in pipe lines, control of blending operations in which two materials of different densities are mixed, determination and control of proportions of reactants in chemical processes, and in numerous other applications where it is desired to determine the density of a substance without the necessity of sampling or without actual access to the material.

### Description of Parts

The Penetron consists of two main parts—the head and the control box. The head contains the radiation source, the detector, a shield between the two and a three-stage preamplifier. It weighs about 7 lb and is connected by a seven-wire



# HERE'S A RUGGED RESISTOR THAT CAN TAKE ABUSE!

THERE'S no need to coddle or baby your resistors if you use "GLOBAL" Ceramic Resistors by "CARBORUNDUM". They are fired electrically at temperatures up to 2500°F. and so can take a lot of punishment.

Further than that "GLOBAL" Resistors are built to retain their established resistance value at normal loading. In addition they will withstand the maximum accidental over-voltage to which they might be subjected in service without suffering a permanent change in resistance. Relatively free from inductance, capacitance and microphonic effects, they have excellent temperature and voltage characteristics.

"GLOBAL" Resistors were among the first composition resistors in the field. Today millions of them are giving splendid service all over the world, in spite of abuse, acting as precision weirs in the electronic arteries and capillaries of radio circuits. They can do a good job for you, too. Test samples will be sent promptly to any manufacturer interested in quality components. The Carborundum Company, Global Division, Niagara Falls, New York.

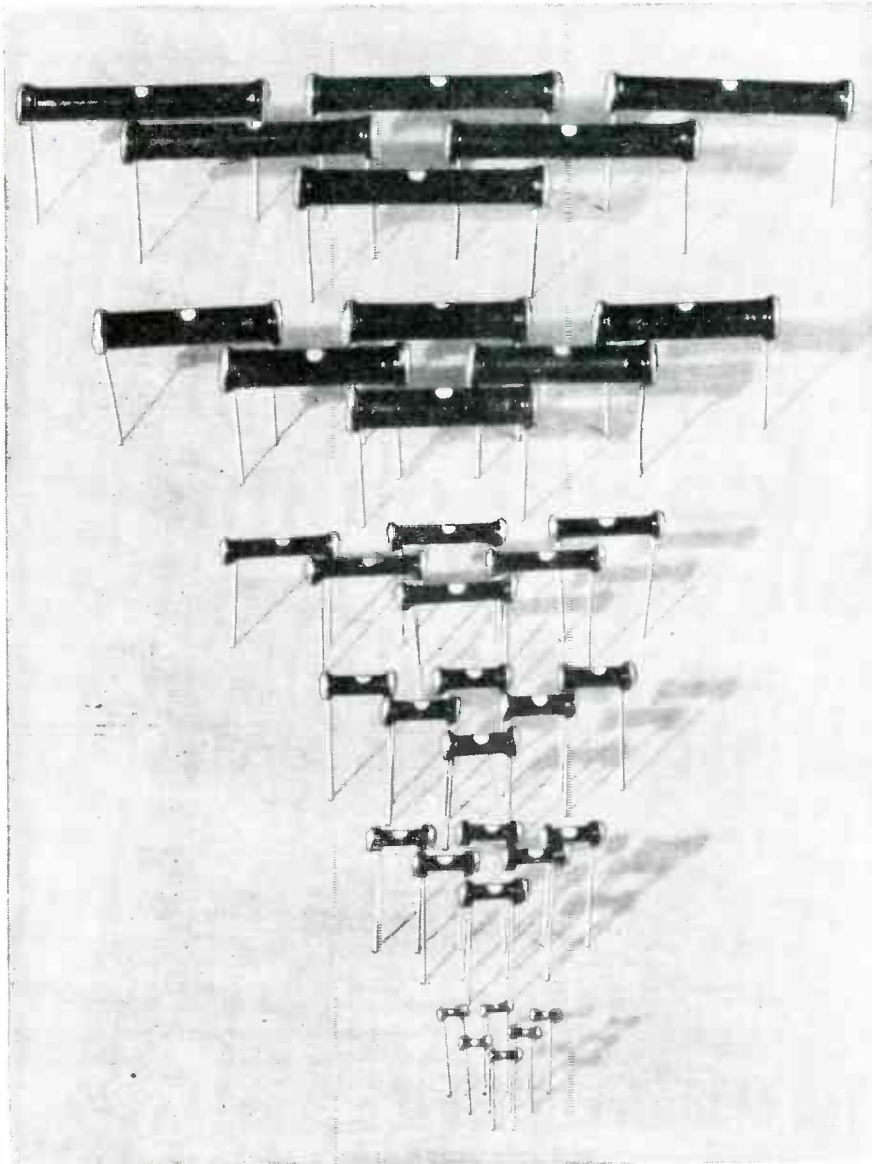

This line of "GLOBAL" Resistors is available in R. M. A. Preferred Resistance Values and in tolerances of 10% and 20%.

#### PHYSICAL AND ELECTRICAL SPECIFICATIONS TYPE "A" RESISTORS

PART NUMBER	WATT RATING	RESISTANCE RANGE	OVERALL LENGTH	OVERALL DIAMETER
997-A	1/5	150 Ohms to 4.7 Megohms	2 1/64"	7/64"
763-A	1/4	47 Ohms to 15 Megohms	5/8"	7/32"
759-A	1/2	33 Ohms to 15 Megohms	3/4"	1/4"
766-A	1	47 Ohms to 15 Megohms	1 1/8"	1/4"
792-A	3	22 Ohms to 150,000 Ohms	1 7/8"	15/32"
774-A	5	33 Ohms to 220,000 Ohms	2 5/8"	15/32"

#### PHYSICAL AND ELECTRICAL SPECIFICATIONS TYPE "CX" RESISTORS

PART NUMBER	WATT RATING	RESISTANCE RANGE	OVERALL LENGTH	OVERALL DIAMETER
997-CX	1/4	1 to 150 Ohms	2 1/64"	7/64"
763-CX	1/2	1 to 47 Ohms	5/8"	7/32"
759-CX	1	1 to 33 Ohms	3/4"	1/4"
766-CX	2	1 to 47 Ohms	1 1/8"	1/4"
792-CX	4	1 to 22 Ohms	1 7/8"	15/32"
774-CX	6	1 to 33 Ohms	2 5/8"	15/32"

*"Global" Ceramic Resistors*  
**by CARBORUNDUM**  
TRADE MARK

("CARBORUNDUM" and "GLOBAL" are registered trade marks of and indicate manufacture by The Carborundum Company)

Buy WAR BONDS

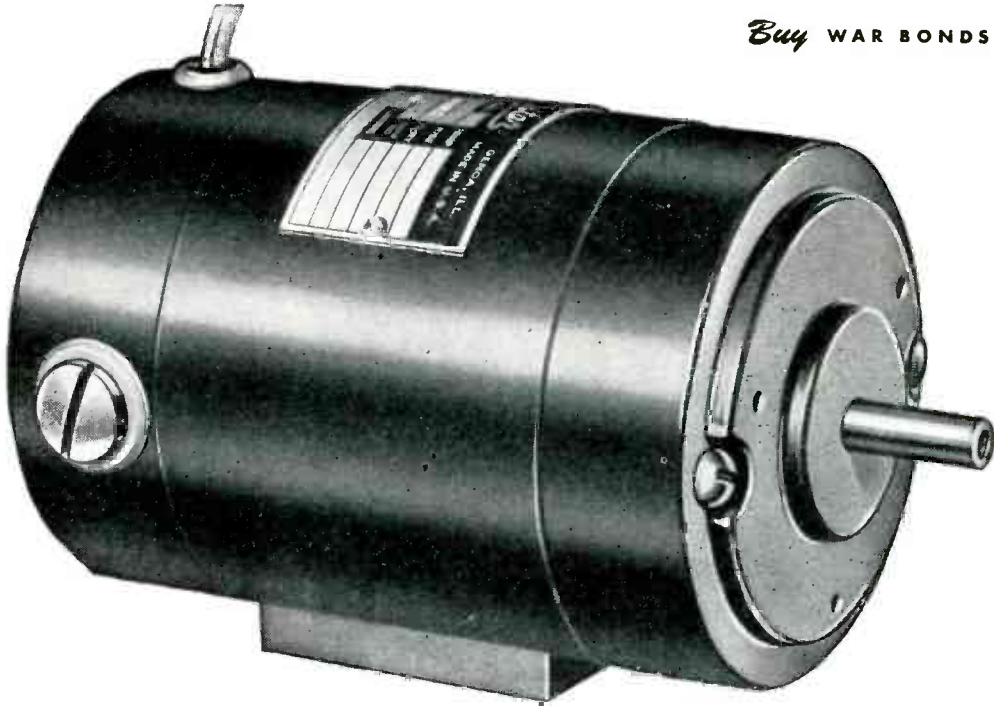

# You can depend on this *Oster* Blower Motor to operate efficiently in marine, aircraft, and electronic service

In planning your post-war product, it is well to remember the design and operating advantages of this weight-saving Oster blower motor. Although it has been especially designed for use in the marine, aircraft, and electronic fields, it may have qualities that fit your particular product. Check these features:

**Housing:** Die cast, zinc field housing and aluminum end brackets. Totally enclosed.

**Bearings:** Single shielded ball bearings lubricated with a grease suitable for any specific application. Bearing housings fitted with steel inserts.

**Windings and Insulation:** Field coils and armature wound with a select grade of insulated copper wire and impregnated

with a high quality heat and moisture resisting insulating varnish.

**Mounting:** Available with either base mounting or machined pads.

**Brushes:** Metal graphite or electro graphite brushes of ample size to assure unusually long brush life. Phosphor bronze or beryllium copper brush springs.

**Temperature Rise:** 55° C. maximum frame Temperature rise at rated output.

**Modification:** Motors can be furnished with special shaft extensions, mounting arrangements, finishes, leads, etc.

Let us help you fit this and other Oster Motors to your requirements.

## John Oster Manufacturing Co.

DEPARTMENT L-28

RACINE, WISCONSIN

PERFORMANCE WITH #3 L-R TURBO TYPE BLOWER		
Type	F-9A-3	F-9-4S
Voltage	115 A.C. 60 CYC.	27 D.C.
Amps. Input	2.7	7
R.P.M.	6000	6000
Rotation	Clockwise Drive End	Clockwise Drive End
Starting Torque in % of F. L. Torque	200	300 — 400

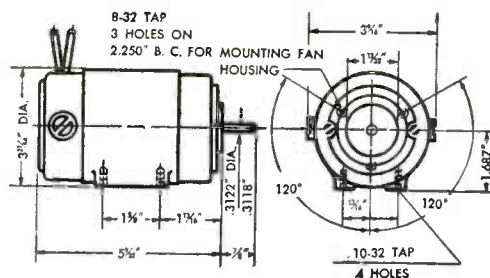

M-28

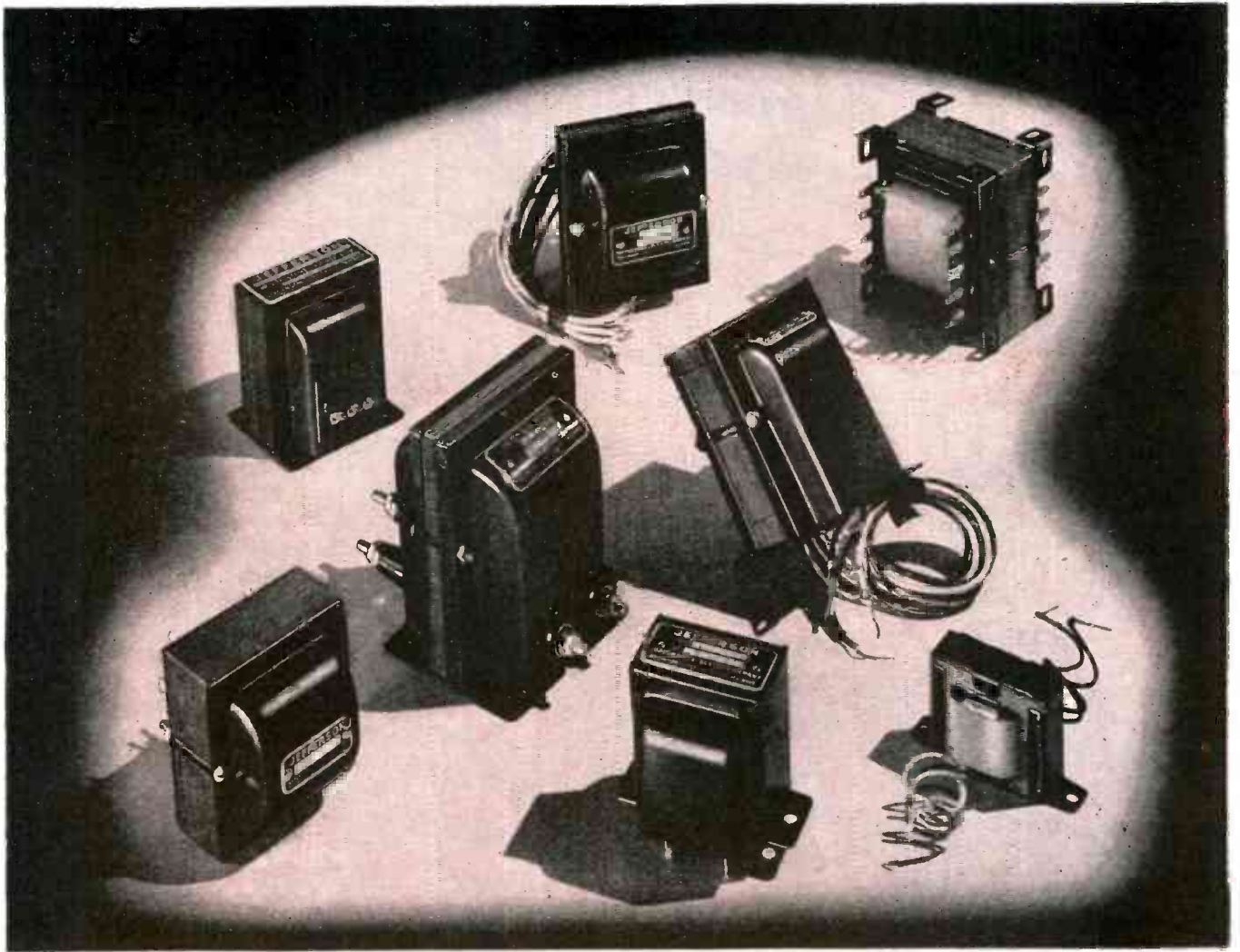

## Quality in Quantity

**W**ITH COMPLETE control of the design, selection of all materials, and methods of manufacture of all parts to the final assembly, inspection and delivery,—Jefferson Electric Transformers are laboratory correct whether required in small lots or hundreds of thousands.

War-time demands have further emphasized the ability to maintain high uniform standards of quality on a mass production basis. Under the stimulus of War effort, advanced types of

machinery, and improved manufacturing technique, you can count on still better Jefferson Electric products for your post-war needs. Consulting now with Jefferson Electric transformer engineering specialists will save time for you later . . . JEFFERSON ELECTRIC COMPANY, Bellwood (Suburb of Chicago), Illinois. *In Canada:* Canadian Jefferson Electric Company, Limited, 384 Pape Avenue, Toronto, Ontario.



# TRANSFORMERS

*Things are Happening Here*

**THAT ARE IMPORTANT**

**TO**

*You*

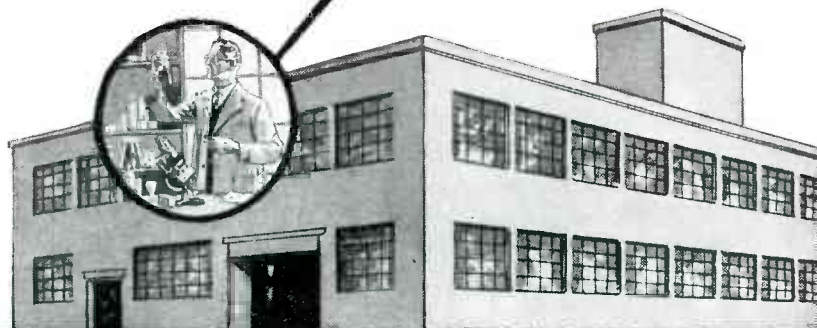

**T**HE exceptionally able group of technicians associated with the Insl-x research laboratory has been instrumental in developing numerous insulation and fungicidal coatings for our armed forces. The same group is now developing important improvements for postwar electrical and electronic insulation. Details cannot be disclosed now—but the day is not far off.

*Write today. We will file your name for reply when details can be disclosed.*

**THE INSL-X COMPANY INC.**

**857 MEEKER AVE., BROOKLYN 22, N. Y.**

CHICAGO

DETROIT

LOS ANGELES

PHILADELPHIA

CLEVELAND

ST. LOUIS

unshielded 75-foot cable to the control box which contains the measuring circuit and the power supply. The head is completely sealed in its metal housing, as required for use in refineries and other locations where explosive hydrocarbons may react to sparks.

The measuring head proper consists of steel tubing  $2\frac{1}{2}$  inches in diameter and 13 inches in length, which can be inserted in various holders. One holder is equipped with two permanent magnets which serve as supporting points and at the same time hold the head firmly in position on iron or steel surfaces. Another holder is provided with a chain clamping device for use on nonmagnetic materials.

If measurements are to be taken on the inside of tubings a pneumatic type holder is used. It is equipped with two pistons which can be moved by compressed air or fluid pressure. These pistons press the head against the inside of a pipe or tube in any desired direction. The clamp is maneuvered with extension handles, and measurements can be made at any desired point and at any desired angle along the inside of tubes of any length.

#### *Smaller Unit*

Another and smaller measuring head utilizes the principle that metal inserted between the source and the detector causes a decrease in the meter reading. The gamma rays are directed tangentially across the tubing. If the wall of the tubing is thinner at some point, the amount of absorbing material is less and the meter reading changes accordingly. This technique works regardless of the curvature of the pipe, and is advantageous in crowded locations like boilers, where some tubes cannot be reached with the more bulky measuring heads. Only one tube is incorporated in this small head, the other two being in a cylinder inserted in the connecting cable a few feet from the head.

The present instrument employs only one milligram of radium as the gamma ray source, as contrasted to 25 milligrams required in earlier models. The radium is supported at the apex of a cone-shaped ele-

*“Supervisory control helps  
put the finger on trouble” ★*



*C. W. Burtis, Chief Engineer  
WPEN, Philadelphia*

This statement by Mr. Burtis, on the value of well-designed supervisory control, brings into sharp focus the extra dependability featured in all Westinghouse transmitters. *For Westinghouse transmitters have more supervisory control than any other type manufactured today.*

Indicator lamps, for example, tell at a glance which circuit has been overloaded, even though the transmitter has returned to the air. “De-ion” circuit breakers supply full overload and undervoltage protection, automatically reduce outage time. Controls reset automatically. Circuit checkup is simplified.

This dependability and efficiency in Westinghouse transmitters are products of on-the-job knowledge gained in 25 years of building and operating radio stations. Your nearest Westinghouse office can give you all the facts on Westinghouse transmitters . . . 5, 10 and 50 kw, AM, and 1, 3, 10 and 50 kw FM. Westinghouse Electric Corporation, P. O. Box 868, Pittsburgh 30, Pa. J-08117

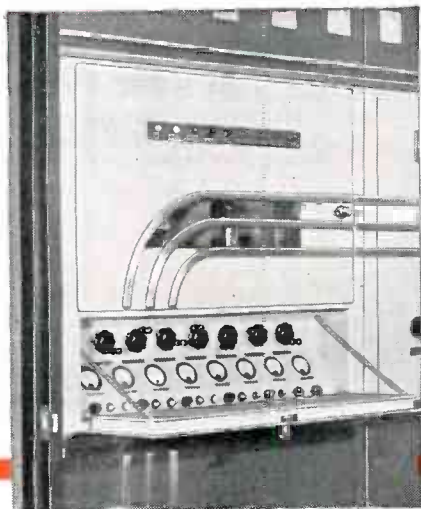

★ “Without a doubt, supervisory control is one of the more worth-while additions to the indication devices on a transmitter. It definitely helps put the finger on any trouble that develops by approximating the sphere of that trouble.”

(Signed) C. W. Burtis



**Westinghouse**  
PLANTS IN 25 CITIES . . . OFFICES EVERYWHERE

*Electronics at Work*

XXV RADIO'S 25th ANNIVERSARY KDKA

*"Yes sir—these  
AMERICAN PHILLIPS SCREWS  
are 100% OK!"*

You quit feeding screws to the scrap-barrel, when you use American Phillips Screws. You will find no burred heads, no broken or drunken threads, no crooked or dull points. That's the way American makes Phillips Screws . . . and American's inspectors make sure that's the way they get to *you*, individually checked for full physical fitness.

So when a worker picks up an American Phillips Screw, that's the screw he drives *right then*. All he has to do is put it onto the 4-winged driver, aim it at the work, pull the trigger of his gun. No fumbling, no dropping, no straining of nerves and muscles. Every American Phillips Screw turns up flush and tight *every time*, with no snags on the screw-head or scars on the work. This unmatched speed . . . based on ease of handling and automatically straight power-driving . . . adds up to total time-savings of as much as 50%. Try them on one job and you'll see that *American Phillips Screws always cost least to use*.

**AMERICAN SCREW COMPANY**

PROVIDENCE 1, RHODE ISLAND

Chicago 11: 589 E. Illinois Street  
Detroit 2: 502 Stephenson Building



PUT THE SCREWS  
ON THE JAPS . . .  
BUY WAR BONDS

**AMERICAN  
PHILLIPS** *Screws*

The Ballentine Record Changer Motor  
is engineered for just one purpose  
... to provide highest efficiency and  
lowest "rumble" for your changer.

This quiet, trouble-free motor  
is the result of expert technical  
design, the most modern manufacturing  
methods and equipment, and  
skilled craftsmanship . . . You can  
depend on the Ballentine Changer Motor.

RUSSELL ELECTRIC COMPANY  
364 W. HURON STREET • CHICAGO 10, ILLINOIS

*Manufacturers of*

**BALLENTINE CHANGER MOTORS**

# AUTOMATIC CONTROLS *Governed by Temperature*

Neither planes, tanks, ships nor guns could operate efficiently without scores of precision built, automatic controls. And wherever temperature is a factor, Chace Thermostatic Bimetal is constantly being called upon by the control builder to serve as the actuating element for his device, for indication, control, or both.

These war-time applications cover a temperature range from  $-100$  to  $+1000^{\circ}$  F. And at any pre-determined point within that range, Chace bimetal may be called upon to give the impetus to start, or to stop, some vital function. That is, it must convert temperature into action; automatically, instantly, and without fail.

Similarly, in the home, appliance manufacturers utilize the known properties of specific types of Chace bimetal to convert temperature into action in devices ranging from toasters to furnace controls, or to refrigerator motor protection.

*There are thirty-five types of Chace Thermostatic Bimetal, each of which offers specific advantages to control builders. Sold in sheets, strips, and finished forms.*

**W.M. CHACE CO.**  
*Manufacturers of*  
Thermostatic Bimetals and Special Alloys  
1630 BEARD AVE • DETROIT 9, MICH.

PENETRON

(continued)

ment, the base of which is attached directly to the housing of the detector. This cone serves to shield the detector from direct radiation emanating from the radium.

The life of the radium source is unlimited. It takes 1690 years to reduce the quantity of gamma ray emission to half of its original value.

Two kinds of detectors for gamma rays are known—the ionization chamber and the Geiger-Muller type of counter. In the Penetron, a high-efficiency Geiger-Muller counter of improved design is employed. The counter is contained in a housing which is fitted longitudinally into the head and is



Measuring head in hydraulic-type holder, showing concentric steel shells used for routine calibration and check of performance

shielded in such a way that it is open to radiation coming from the wall to be measured. Back-scattered radiation enters the counter and sets off current discharges or pulses. The rate at which these pulses of current are generated is proportional to the intensity of the radiation entering the counter, which in turn is a function of the wall thickness.

#### *Pulse Amplifier*

The pulses of current produced in the detector are extremely small. Since these pulses must be transmitted through 75 feet of cable it is necessary that they be increased in magnitude sufficiently to be distinct when they are picked up at the measuring circuit in the control box. This function is performed by the three-stage preamplifier located in the head of the instrument.

The pulses of current are further amplified in the control box and by means of a special electrical circuit are integrated to produce a direct current, the magnitude of which is proportional to the number of current pulses created per unit of time in the detector by the back-scattered radiation. The current is



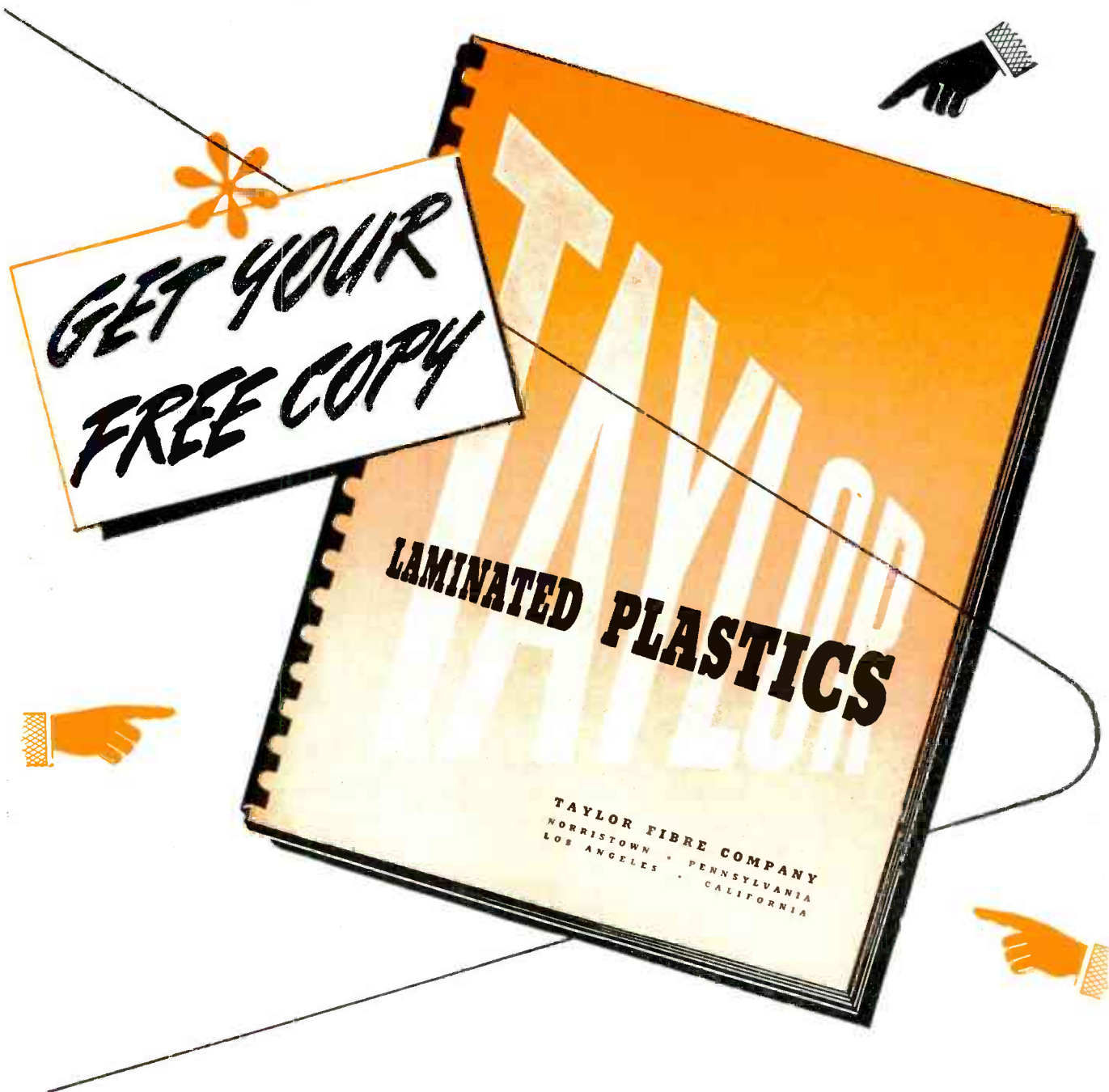

## \*New Catalog and Handbook of Taylor Laminated Plastics

Just off the press! A 54-page catalog and handbook containing the latest factual data, standards, and engineering information on Taylor Phenol Fibre and Vulcanized Fibre sheets, rods, tubes, and fabricated parts. An invaluable reference book for purchasing agents,

design engineers, and manufacturers whose products contain laminated plastic parts. The scarcity of paper has forced us to make this a "limited edition," so if you want to be sure of getting a copy before the supply is exhausted, write today on your business letterhead.

# **TAYLOR FIBRE COMPANY**

**LAMINATED PLASTICS: PHENOL FIBRE · VULCANIZED FIBRE · Sheets, Rods, Tubes, and Fabricated Parts**  
NORRISTOWN, PENNSYLVANIA · OFFICES IN PRINCIPAL CITIES · PACIFIC COAST HEADQUARTERS: 544 S. SAN PEDRO ST., LOS ANGELES 13

# Is Control of Temperature to $\pm .10^\circ$

## Close Enough?

# MICRO SWITCH

### SNAP-ACTION HELPS BURLING INSTRUMENTS TO GIVE ALMOST PERFECT CONTROL

Recorded temperature of low temperature test oven controlled by Micro Switch equipped Burling Temperature Control which shows almost perfect control. The "hump" in the line is where the switch was changed from normally open to normally closed.

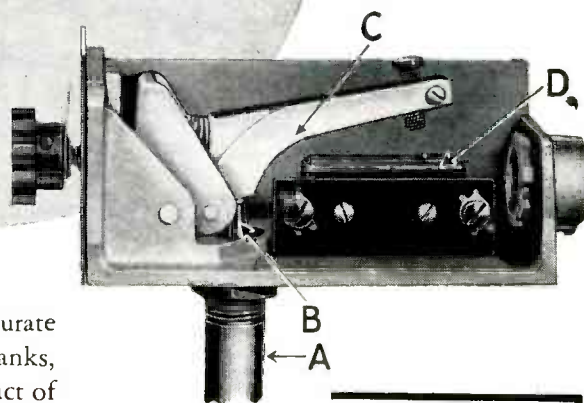
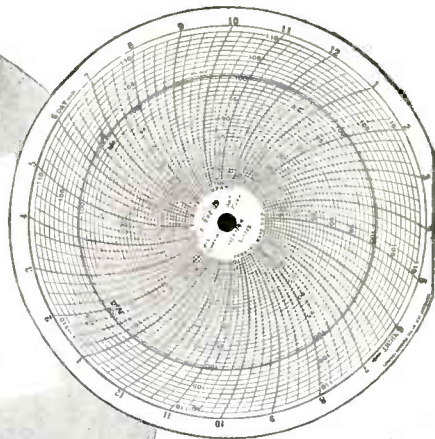

Burling Temperature Controls are designed to give the most accurate control of temperatures of cold boxes, low temperature cabinets, tanks, ovens, incubators and high temperature furnaces. They are a product of the Burling Instrument Company of Newark, N. J.

The basic operating principle of these precise controls is the differential expansions of solids. The difference in expansion of the two members is multiplied by a lever which operates a Micro Switch snap-action switch. This switch, in turn, electrically controls the heat supply.

The almost perfect control indicated in the test illustrated was made in a low temperature test oven with an aluminum alloy tube 30" long. The small variation would indicate a control as fine as plus or minus  $.10^\circ$ .

Such control is possible because the precise, sensitive Micro Switch action permits a snap from one position to another with extremely small motion. The operating force required is so small that the slight expansion of tube is ample.

This application of Micro Switch products is typical of the many uses industry has found for these tiny, sensitive switches in thermostats, gages, and fine instruments of many types.

#### HERE IS HOW IT WORKS

Difference in expansion between outside tube "A" and inside tube "B" causes lever "C" to contact switch "D." This contact electrically controls the operation of the heating element.

Micro Switch engineers, experienced in the applications of millions of these precise, snap-action switches to products for both war and peace, will be glad to show you how they can add long life and reliability to your product at lower cost. Send for the Micro Switch Handbook - Catalog No. 60 today.



LET'S ALL BACK THE ATTACK



BUY EXTRA WAR BONDS

© First Industrial Corporation



The basic switch is a thumb-size, feather-light, plastic enclosed, precision, snap-action switch, underwriters' listed and rated at 1200 V. A., at 125 to 460 volts a.c. Capacity on d.c. depends on load characteristics. Accurate reproducibility of performance is maintained over millions of operations. Basic switches of different characteristics are combined with various actuators and metal housings to meet a wide range of requirements.

# 101 SERIES

# Amplifiers

WITH RACK PANEL OR WALL MOUNTING ACCESSORIES



Input impedance 600 ohms and bridging. Gain 600 ohm input 61 db., bridging input 46 db. Frequency response 30 to 16,000 c.p.s. either input—600 ohm output  $\pm 0.5$  db., 30 ohm output  $\pm 1$  db. Power output—production run average: +47 V.U. with less than 3% RMS harmonic content.



**TYPE 201-A** Wall Mounting Cabinet permits universal installation of 101 Series Amplifiers to any flat surface. Well ventilated and designed for maximum accessibility for servicing and convenience of installation. Standard aluminum gray finish.



**TYPE 7-A** Modification Group permits 101 Series Amplifiers to mount on standard 19" telephone relay racks. Occupies 12 1/4" rack space. Allows servicing from front of rack. Standard aluminum gray finish.

**THE TYPE 101** Series Amplifiers are the results of twenty years' experience in the sound engineering field. They are identical with the exception of the output coil.

Type 101-A has output impedance adjustments to match loads from 1 to 1000 ohms and possesses excellent low frequency waveform at high output levels.

Type 101-B with a single nominal 6 ohm output is intended for use with wide range loudspeakers representing an 8 to 16 ohm load. Its output coil with a single secondary provides improved efficiency and even better waveform at high levels of low frequencies.

Type 101-C answers the demand for a good amplifier at lower cost. This lower cost is obtained by the use of a less expensive output coil with the only change being that the low frequency waveform is not as good as the A or B types but is equal to or better than any contemporary commercial amplifier. Output impedance is adjustable to loads of 1 to 1000 ohms.

## The Langevin Company

INCORPORATED

SOUND REINFORCEMENT AND REPRODUCTION ENGINEERING

NEW YORK

37 W. 65 St., 23

SAN FRANCISCO

1050 Howard St., 3

LOS ANGELES

1000 N. Seward St., 38

# PRECISION CAPACITORS

by

# CARDWELL

An outstanding Cardwell wartime achievement is the development of precision worm drive capacitors, of maximum stability and resettability, for use in various types of frequency meters.

Although not standard catalog items, the three types illustrated are typical of the possible variations of this general design which is widely used in Cardwell instruments built for the Army and Navy. Perhaps one of them is the answer to your design needs for an S.L.F. type precision capacitor of highest quality.

**PART No. 4.080**  
21-220 mmfd.;  
airgap .030"

As used in S. C. Frequency Meter covering range of 125-20,000 KC, 125-250 KC low band fundamental, 2 MC-4 MC high band fundamental.

**PART No. 4.400**  
8-130 mmfd. per section;  
airgap .020"

Used in ATSC Frequency Meter covering fundamental range of 85-200 MC and to 1000 MC harmonically.

Four studs support special trimmer and compensator capacitors which are not shown.

**PART No. 4.200**  
15-125 mmfd.;  
airgap .027"

In another ATSC Frequency Meter, this condenser tunes the oscillator over fundamental range of 20-40 MC and to 250 MC harmonically. Has adjustable compensator and trimmer.

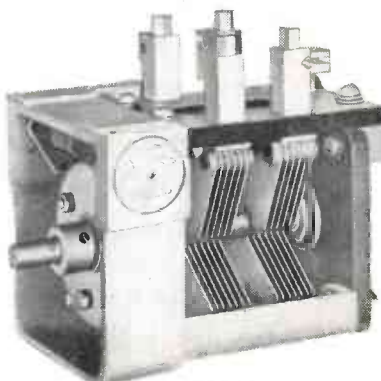

## CARDWELL QUALITY PRODUCTS

# CARDWELL CONDENSERS

THE ALLEN D. CARDWELL MANUFACTURING CORPORATION  
81 PROSPECT STREET  
BROOKLYN 1, N. Y.

PENETRON

(continued)

measured by means of a microammeter located on the face of the control box. The meter readings are readily converted to the wall thickness of the object being measured, by referring to the appropriate calibration curve.

The instrument is designed to operate from a 115-volt, 60-cycle a-c line. The total power consumption is approximately 100 watts.

### Uses

Experimental work involving the substitution of a neutron source and detector for the gamma-ray source and detector has indicated that wall thicknesses up to four inches of steel can be measured with a high degree of accuracy.

In addition to liquid level and specific gravity applications, the various versions of the Penetron may be used for a wide variety of different purposes, including chemical process control and ship hull and boiler inspection.

The Penetron was perfected in the laboratories of the Texaco Development Corp., New York City. Dr. Gerhard Herzog directed research and development

Engineering Laboratories, Inc., Tulsa, Oklahoma, has been exclusively licensed for the sale and manufacture of the instrument. This company in 1937 developed radioactivity well logging, which discovers and records bypassed oil producing areas through steel well casing. The method utilizes neutron measurement which is somewhat similar to the Penetron method, and has been responsible for discovery of hundreds of producing wells.

• • •

## Electrostatic Deposition of Phosphor Powders

THE CONVENTIONAL manufacturing process used in coating fluorescent tubing has been to suspend the phosphor powder in a solution which is allowed to flow through the glass tubing after it has been carefully washed. The tubing is then allowed to dry, after which it is baked to remove the liquid.

In an electrostatic method using the Westinghouse Precipitrons, the tubing is slipped over an ionizing wire and a high potential placed

# SMOOTH COMMUTATION!

## A.C. VOLTAGE CONTROL with TH 2½A TRANSTAT

### *Brush Arm Assembly*

One piece die casting permits good heat dissipation, provides a simple means of replacing the brush and protects the commutator against contact with brush holder if brush should break or loosen.

### *Core and Coil Impregnated FOR Long Service*

Each turn of vinyl acetal insulated wire is PERMANENTLY anchored by impregnation of whole core and coil with phenolic resin, followed by baking.

### *Broad Commutating Surface*

Ground from parallel wires on outer periphery of coil, forms long even segments with solid insulation necessary to avoid shorted turns. Greater contact area results in a lower operating temperature. Smooth, mirror-like finish provides a practically frictionless brush track.



## Write

FOR THIS  
NEW FOLDER!

Complete description, including construction details, performance curves, wiring diagrams, ratings, electrical data and applications covered. Ask for Bulletin No. 171-01.

AMERICAN TRANSFORMER COMPANY  
178 Emmet Street, Newark 5, N. J.

# AMERTRAN

MANUFACTURING SINCE 1901 AT NEWARK, N. J.

Pioneer Manufacturers of Transformers, Reactors and  
Rectifiers for Electronics and Power Transmission



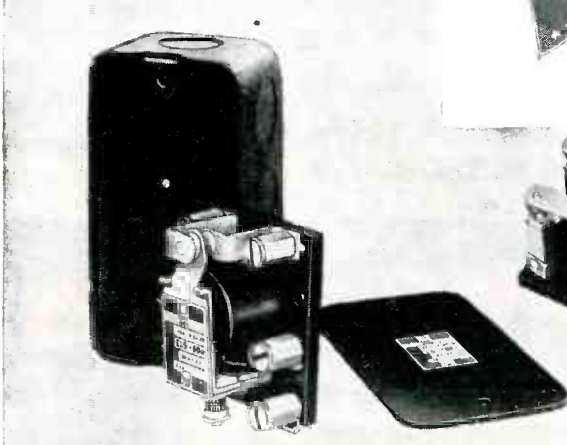
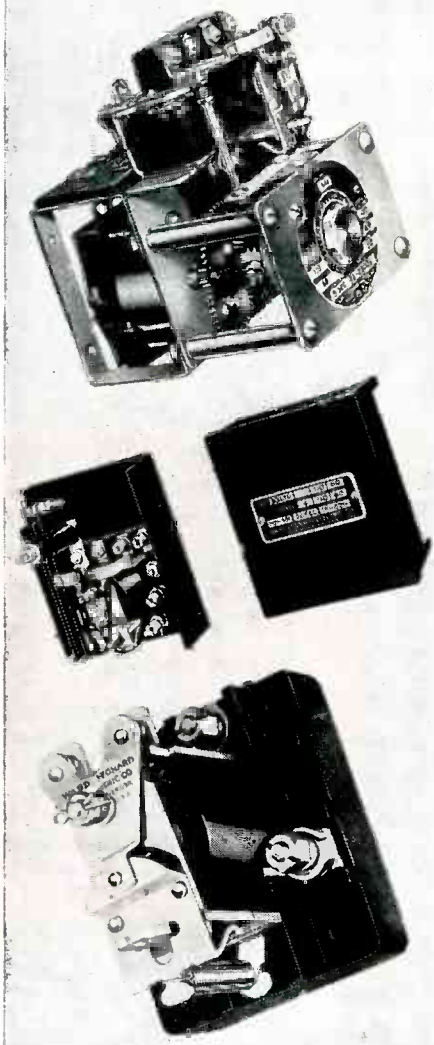
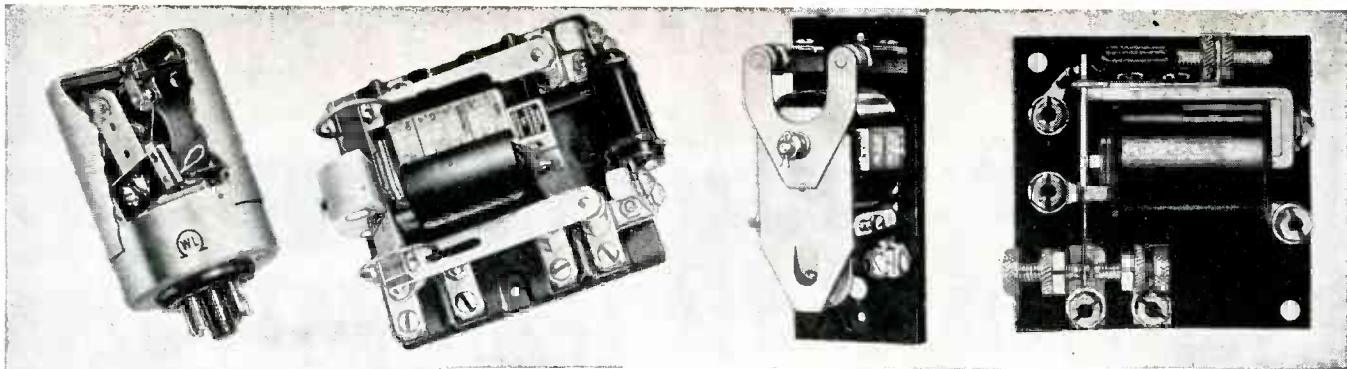

# RELAYS

## FOR POSTWAR JOBS

It is an interesting commendation that many of the regular line of Ward Leonard Relays have so effectively served the needs of our Army, Navy and Air Corps. This is a tribute to the design and quality of Ward Leonard routine production.

Designers of postwar products may rest assured that when they select relays from the Ward Leonard line, they have chosen relays of proven merit. The line includes types and capacities for practically every commercial, industrial and communications application.

*Bulletins available describing light, intermediate and heavy-duty relays in various contact combinations. Send for bulletins of interest to you.*



★ ★ ★  
BUY  
MORE WAR  
BONDS



# WARD LEONARD

## RELAYS • RESISTORS • RHEOSTATS

Electric control  devices since 1892

*Offices in all principal cities*

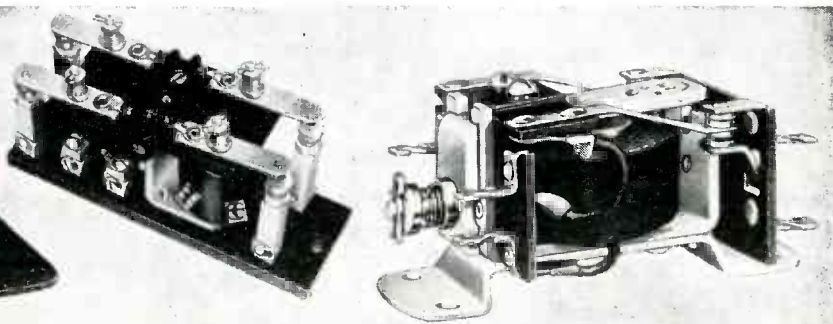

WARD LEONARD ELECTRIC COMPANY • 32 SOUTH ST. • MOUNT VERNON, N. Y.



# vibration IS destructive

This is the reason why Robinson Vibrashock\* suspensions are used for the important role of supporting the Western Electric ARC-1 Navy Transmitter Receiver, which is installed in all Navy fighter planes.

Robinson engineers have adapted Vibrashock, the new principle of vibration control, to dozens of different types of vitally important airborne equipment. All this equipment needed special protection from shock and vibration that was not attainable with conventional types of shock mounts.

Over 90% of all vibration throughout the aircraft operating range is effectively eliminated with Robinson Vibrashock. No other shock mount can offer so much in vibration absorption. This performance extends the service life of airborne equipment and drastically reduces maintenance and overhaul time and expense.

More and more manufacturers and users of airborne equipment are turning to Robinson for that engineering skill which is reflected in the important jobs Vibrashock is now performing.

Our services are available to aircraft, radio, and electronic manufacturers and users in connection with any mechanical or electronic equipment requiring protection from vibration and shock.

\*Trade Mark

## ROBINSON AVIATION, INC.

730 Fifth Avenue, New York 19, N. Y.  
3757 Wilshire Blvd., Los Angeles 5, Calif.

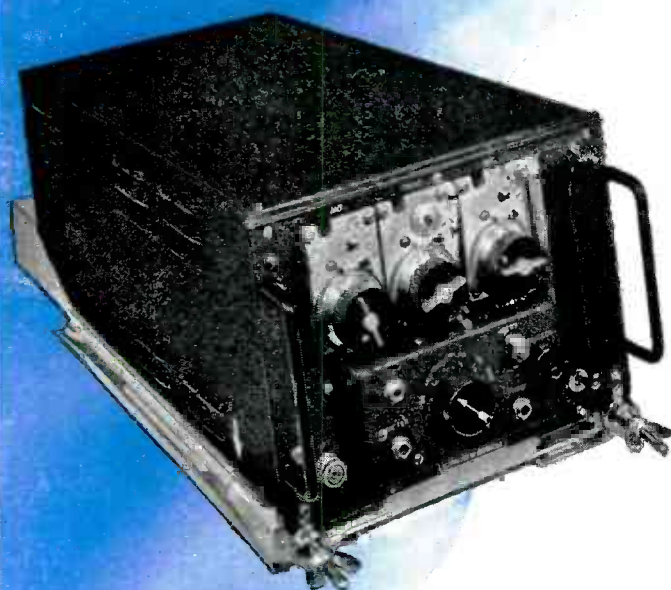

The ARC-1, designed by Bell Telephone Laboratories, is manufactured by Western Electric Company. This Navy standard combination transmitter and receiver is not only used on all Navy fighter planes but also on battleships, carriers and submarines.

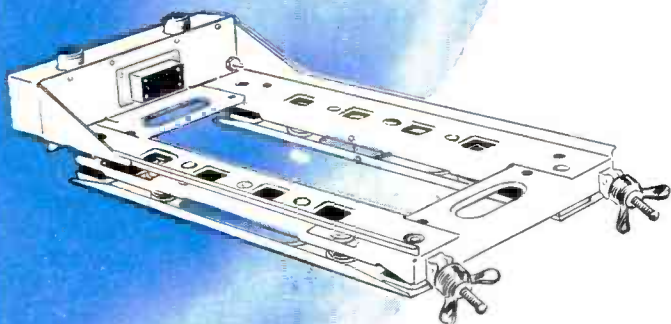

The Robinson Vibrashock suspension—Model W-386—supports all the ARC-1 Western Electric Transmitter Receivers. This is an example of the way in which the Vibrashock principle can be adapted to the form factor and space requirements of electronic equipments.

FOR SPECIALIZED  
ELECTRONIC EQUIPMENT  
RELY ON ANDREW CO.

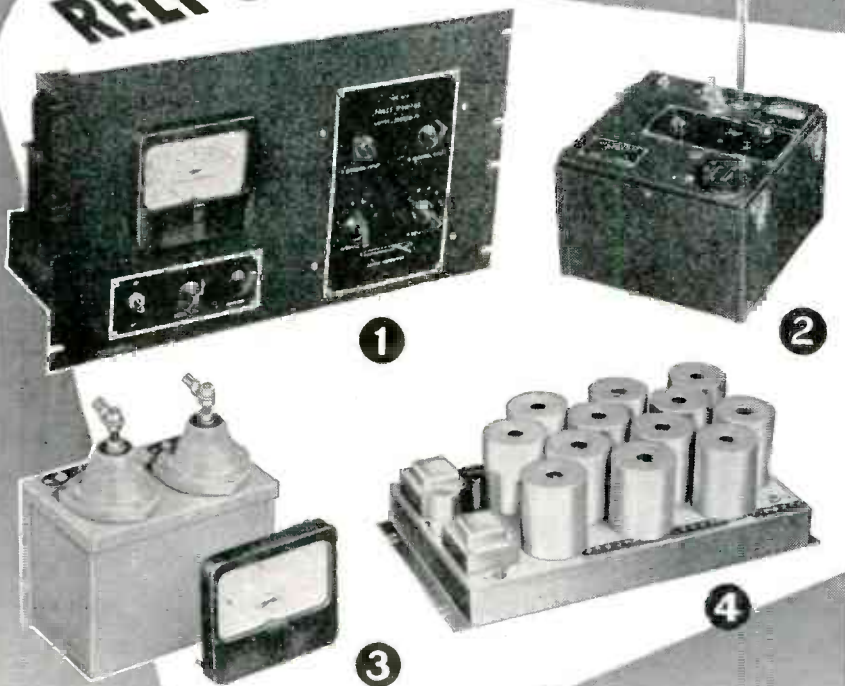

The fine electronic instruments shown above are examples of the precision production that characterizes all ANDREW equipment. Designed and built by skilled engineers, ANDREW CO. electronic equipment is used the world over wherever specialized apparatus is needed.

- ① **TYPE 40A PHASE METER**—This direct reading, precision instrument measures in degrees the phase angle between currents in radiating elements of a directional antenna system. It operates on a signal input of only 200 millivolts and may also be used for general laboratory work.
- ② **TYPE 291 HF OSCILLATOR**—This portable battery operated oscillator is used for checking high frequency receivers, especially aircraft type. The frequency range is from 49 to 154 Mc. with modulation frequencies of 70, 90, 400, 1300 and 3000 cycles. This unit contains a collapsible whip antenna for checking receivers without direct connections, and provides 2 coaxial terminals for low and high level output.
- ③ **TYPE 708 REMOTE ANTENNA AMMETER**—This unit contains a diode rectifier with a DC micro-ammeter calibrated in RF amperes, and is used for indicating antenna current at a point remote from the antenna. This instrument is used by hundreds of broadcast stations.
- ④ **TYPE 760 ANTENNA TUNING UNIT**—This is used for coupling several antennas into a single receiver, or for coupling a single antenna into a number of receivers. Containing six RF amplifiers with an associated power supply, each amplifier stage in this unit has low impedance input and output circuits. These may be series connected for use with a single receiver or antenna. This equipment is especially useful where antennas are remotely located from receivers.

Send in your orders now so that you may receive early delivery as soon as military restrictions are lifted.

**ANDREW CO.**

363 East Seventy-fifth Street, Chicago 19, Illinois

between wire and the tube. A smoke of the dry phosphor is made and blown through the tube. The phosphor particles are given a positive charge and are driven by the strong electrostatic field to the glass walls where they give up their charge and adhere firmly to the glass. A blast of moisture-saturated warm air smooths the inner surface.

Because of greater uniformity of phosphor powder distribution by the electrostatic method, a gain of three to four percent in light efficiency is obtained. The ionized dust particles strike the glass, give up their charge, and immediately become insulating, leaving only uncovered areas to attract more dust.

In the liquid-flow method, the draining end of the tube received more powder than the upper end. The distribution of the phosphor, therefore, cannot be designed for maximum energy transformation.

With the electrostatic method the tubing does not have to be treated at as high a temperature, which means less phosphor deterioration. For curved lamps the phosphor dusts are preionized and blown into the empty tube.

Tubing now does not have to be washed, as any clinging tiny dirt speck does not show. With the flow method, a small spot of dirt became an island because of the eddies of fluid around it. Using dry phosphors eliminates both the problem of handling liquids and the hazard attendant to volatile solvents.

• • •

### Vacuum-Tube Anticipator Controls Furnace Temperatures

AN INCREASE in the sensitivity and response of conventional temperature controls oftentimes is provided by a new vacuum-tube thermocouple device. The unit anticipates changes in electric-furnace temperatures and takes corrective steps to minimize the cyclic swings in temperature characteristic of most furnace controls.

The efficiency of the device is demonstrated by one heat-treating furnace that varied over a range of 50 deg F (plus or minus 25 deg.) prior to supplementing the control with this anticipator. With



# Why Speed Nuts are *FIRST* with all five



ENGINEERING



MANAGEMENT



PURCHASING

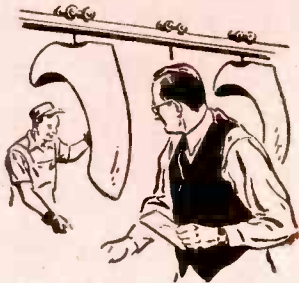

PRODUCTION



TIME STUDY AND COSTS

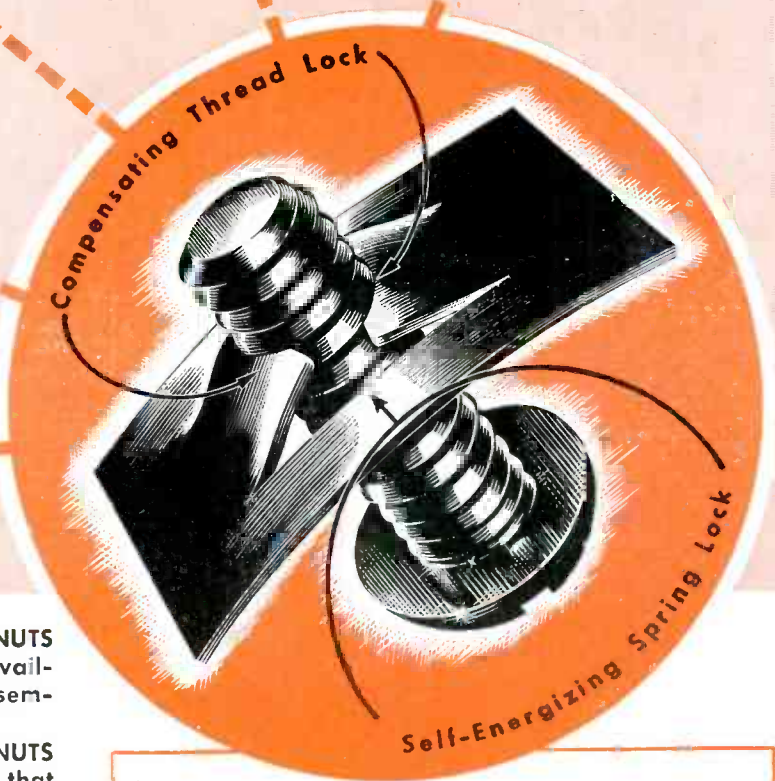

**FIRST** with Engineering because **SPEED NUTS** simplify design problems and are either available, or can be produced to meet any assembly requirements.

**FIRST** with Management because **SPEED NUTS** are time-tested, vibration-proof fasteners that improve the quality, and prolong the life of the finished product.

**FIRST** with Purchasing because **SPEED NUTS** lower inventory costs, reduce stocking problems, and are **DELIVERED** on time. Production and service facilities are unlimited.

**FIRST** with Production because **SPEED NUTS** eliminate extra handling of production parts, are applied faster and easier, and compensate for a wider range of commercial tolerances.

**FIRST** with Time Study and Cost because **SPEED NUTS** slash total net assembly costs to a fraction of other assembly methods.

Investigation will prove that **SPEED NUTS** should be **YOUR** first choice, too. Write for information today.

## NOTHING LOCKS LIKE A SPEED NUT

*TWO* distinct forces are exerted on the screw, as a **SPEED-NUT** is tightened.

*First*, a compensating thread lock, as the two arched prongs move inward to lock against the root of the screw thread. These free-acting prongs compensate for screw thread tolerance variations.

*Second*, a self-energizing spring lock, created by the compression of the arch in both the prongs and base. The combined forces of the thread lock and spring lock definitely prevent vibration loosening.

**TINNERMAN PRODUCTS, INC. • 2106 Fulton Road, Cleveland 13, Ohio**

**Speed Nuts** 

PATENTED

\*Trade Mark Reg. U. S. Pat. Off.

**FASTEST THING IN FASTENINGS... OVER 3000 SHAPES AND SIZES**

# ELECTROSTATIC VOLTMETER

PORTABLE  
PROJECTING  
FLUSH

*For  
Accurate  
Measurement  
In High Impedance  
Circuits*



#### RANGES

- 0- 150 Volts
- 0- 300 Volts
- 0- 450 Volts
- 0- 600 Volts
- 0- 750 Volts
- 0-1000 Volts
- 0-1500 Volts
- 0-2000 Volts
- 0-2500 Volts
- 0-3000 Volts
- 0-3500 Volts

**FERRANTI ELECTRIC, INC.**

30 ROCKEFELLER PLAZA  
NEW YORK, N. Y.

Ferranti Electric, Ltd., Toronto, Canada • Ferranti, Ltd., Hollinwood, England

# How to make **BIG** plastic parts seem LITTLE



**R**adio cabinets, housings, washing machine agitators and such—all the larger and more complicated pieces we used to mold before the war—all will go on the production schedules of smaller, simpler pieces when we get into normal production again. They will have better finishes, more uniform cure, truer color and freedom from internal stress. In other, shorter, words, "Happy Day!"

All we'll have to do is hook up our battery of Heatronic units (*first* in the

industry—and still growing) to serve our 500-ton presses.

Better start figuring now on how Plastics plus Heatronics can fit into *your* postwar production plans. But figure it with a custom molder whose reputation for molding already combines with real Heatronics knowledge—a molder like Kurz-Kasch. We mold all materials by compression and transfer—we handle the whole job from design to delivery—our experience with Heatronics dates back to the first unit

RCA sold—and we've been growing with the plastics industry since it began.

Isn't that the kind of organization you'll want for your plastics production? Yes? Just write!

### "A Businessman's Guide to the Molding of Plastics"

Send for your free copy of this illustrated brochure. Just write to Dept. 7 on your letterhead and we'll send it with our compliments.



# Kurz-Kasch

*For over 28 years Planners and Molders in Plastics*

Kurz-Kasch, Inc., 1425 South Broadway, Dayton 1, Ohio. Branch Sales Offices: New York • Chicago • Detroit • Indianapolis • Los Angeles • Dallas • St. Louis • Toronto, Canada. Export Offices: 89 Broad Street, New York City

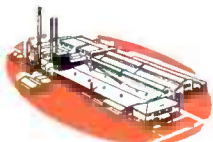

# Unusual and Vital ELECTRONIC EQUIPMENT

PRODUCED BY

## TECH LAB

SUBCONTRACTING DEPT.



Special Short Wave Transmitter  
Range: 1-16 megacycles on  
one dial.



Development of special  
hearing aid analyzer for  
Western Electric Company.



Production Test Set to test varistors. A sensi-  
tive wheatstone bridge arranged with  
switching means for  
quickly checking a  
number of varistors  
in rapid sequence.

Manufacturers have continually called upon the modern facilities of Tech Lab Subcontracting Department to assist them in the production of unusual and vital electronic equipment. Our Engineering Department is ready to assist you with your production problems.

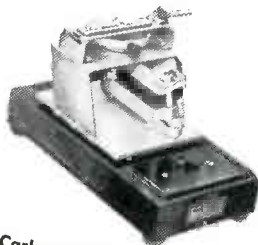

Carbon filling machines for  
precision filling of carbon  
microphones.

**TECH**  
LABORATORIES

MANUFACTURERS OF PRECISION  
ELECTRICAL RESISTANCE INSTRUMENTS

15 LINCOLN STREET, JERSEY CITY 7, N. J.

FURNACE CONTROL

(continued)

the anticipator, the variation was five deg F ( $\pm 2\frac{1}{2}$  deg). The vacuum-tube unit consists of two thermocouples of different thermal capacity and an electric heating element. These are enclosed in an evacuated glass envelope.

### Advantages

When a furnace is controlled by a single thermocouple in the heating chamber, the flywheel effect of the furnace thermal capacity causes overshooting on the heating and cooling portions of the control



A vacuum-tube thermocouple, that anticipates temperature changes of an electric furnace, is adjusted by its inventor, M. J. Manjoine of Westinghouse Research Laboratories

cycle. This action results in a considerable temperature range between the high and low temperatures of the cycle.

The vacuum-tube unit, because of the different characteristics of the thermocouples used, reacts to temperature changes quicker than the furnace and initiates the control operation sooner and minimizes temperature fluctuation. Its two thermocouples and the control thermocouple in the furnace are connected in series so that the polarity of the couple with less thermal capacity is additive and the couple with greater thermal capacity is subtractive with respect to the furnace couple.

The heating element is energized by the same power source that connects the control mechanism and the relays that operate the main

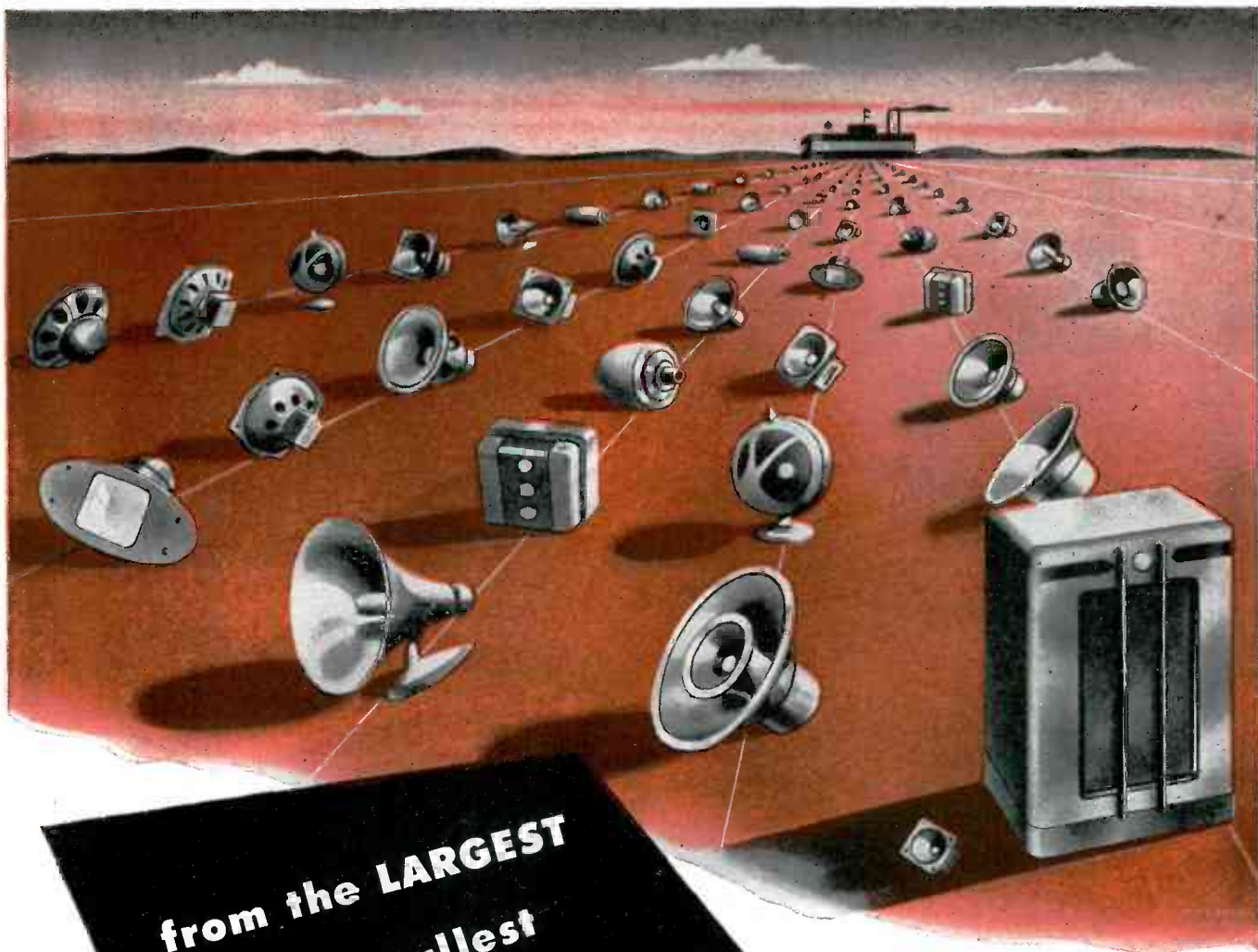

**from the LARGEST  
to the smallest**

**Utah's post-war line of quality speakers . . . the most complete ever available . . . will include standard and high fidelity PM's, all using ALNICO 5.**

*Ever since radio speakers have been made, Utah has been a leader. Electro dynamic and P.M. speakers, (based on the new industry standards) . . . wide range (ideal for FM reception) . . . dual speakers . . . cabinet speakers . . . trumpets . . . whatever your speaker requirements might be, Utah can meet your needs. That's why the Utah Franchise is the most valuable franchise a radio parts distributor can own.*



**UTAH RADIO PRODUCTS COMPANY • 820 ORLEANS STREET • CHICAGO 10, ILL.**

Utah Electronics (Canada) Ltd., 300 Chambly Road, Longueuil, Montreal (23) P.Q. • Ucoa Radio, S.A., Misiones 48, Buenos Aires



**"Where Can We Get Quality Coils  
PLUS High Production?"**

**"BRIDGEPORT!  
Their war record proves it!"**

**Look at  
Bridgeport's  
Service Record**



Right now, search coils and variometers, built to meet and surpass the most exacting military specifications are leaving Bridgeport by the carload. To do this big war job, Bridgeport has developed the facilities and the personnel to combine quality with high production.

After the war, that combination will be valuable, you will also get the advantage of Bridgeport's location that assures fast, trunk line service to any point in America. Place your order NOW to establish a priority on Bridgeport's postwar production schedule.

**BRIDGEPORT**

**MANUFACTURING COMPANY**  
Bridgeport, Illinois

R. F. Coils • R. F. Chokes • I. F. Transformers  
Transmitting Coils • Transmitting Chokes

# First in Circuit Protection

## LITTELFUSE

### 3 AG and 3 AB Fuses



Littelfuse, the first manufacturer to receive Underwriters' Approval on glass-enclosed fuses in current ratings over 3 amps at 250 volts NOW has Underwriters' Approval on fibre-enclosed fuses from 10 amps to 20 amps at 250 volts.

These 3 AB "TINY MIGHTY" fuses (1¼x¼ dia.) will take the place of bulky cartridge or plug fuses and mountings used in heavy-duty electric appliances, power supplies, amplifiers, communications and electronic equipment, radio, motor circuits, etc. To reduce fusing space and weight get approved protection with 3 AG and 3 AB "TINY MIGHTY" Littelfuses.

Ranges of Underwriters' Approved 3 AG Littelfuses, 1/16 amp to 8 amps inclusive; Underwriters' Approved 3 AB "TINY MIGHTY" Littelfuses, 10 amps to 20 amps inclusive at 250 volts or less.

#### LITTELFUSE INCORPORATED

4757 N. Ravenswood Ave., Chicago 40, Illinois

Plants in Chicago and El Monte, California.

## QUALITY SERVES

Quality is built on the firm foundation of unselfish service. Before men can desire to build quality into their work, they must first desire to serve their fellow men well. Mediocre and inferior men build quality through pressure of competition or fear of censure. Leaders of men give and maintain quality because in so doing they render the kind of service they believe is worthwhile, and because they desire the satisfaction, recognition and rewards their leadership merits. Not the least of these satisfactions is the improvement of standards in those who must follow the leader.

True service demands the best quality.

*W. J. Smith*  
President

# LITTELFUSE



# Incorporated

★  
**Max.  
 12 Grams  
 Pressure**

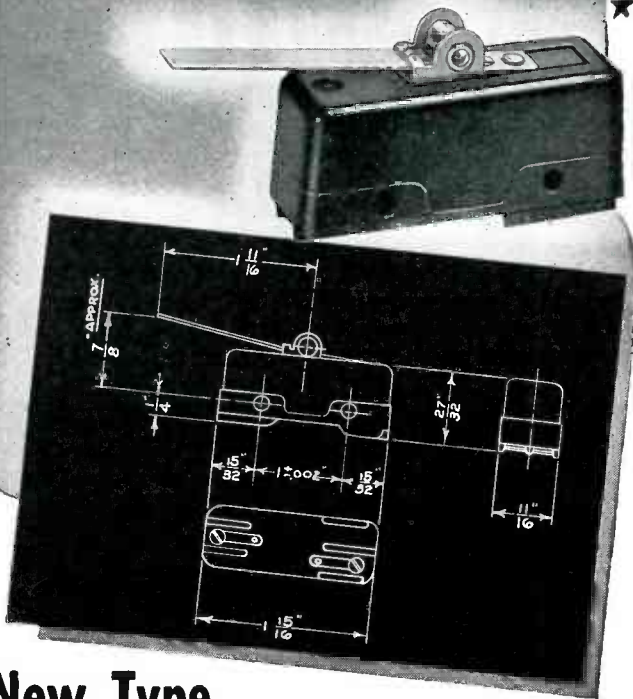

**New Type**

**Acro Snap**

**Switch**

You can now get Acro precision and long life in a snap-action switch requiring only 12 grams maximum operating pressure. Some special models have been built with operating pressures as low as 6 to 8 grams. Like all Acro switches this new hinged leaf type incorporates the famous patented beryllium rolling spring. Pretravel is approx.  $3/32$ " ; overtravel, approx.  $3/16$ " ; movement differential, approx.  $.040$ " ; rated 10 amps. at 115 volts A.C. Available for normally open, normally closed and double throw circuits. This is just one of many compact, time-tested Acro designs for better current control. Write for new catalog today.

**THE ACRO ELECTRIC COMPANY**

1316 Superior Avenue

Cleveland 14, Ohio

power contactors. Thus the furnace and instrument heating elements operate together. The two couples in the instrument are equidistant from the heater but the element with the lesser thermal capacity reacts first to changes in heater element temperature.

#### *Operating Cycle*

When the two couples in the anticipator are at the same temperature, the voltage from the control thermocouple to the control mechanism is constant. When the control thermocouple causes a change in control current, the change is felt first in the two thermocouples in the anticipator. However, the thermocouple with the lower thermal capacity heats faster than the other and the thermocouple voltage at the temperature control mechanism is increased. This increased voltage causes the controller to change to cooling, thus preventing the furnace temperature from overshooting the desired maximum. When the furnace is in the cooling portion of the cycle, the anticipator thermocouple with larger thermal capacity cools more slowly and its reversed polarity causes the control mechanism to change to heating and keep the furnace temperature from overshooting the minimum limit. A variable resistance in the heater circuit of the anticipator provides a means of controlling the frequency of operation of this supervisory furnace-temperature control.

• • •

#### **Moulding Sponge Rubber With Dielectric Heating**

DEVELOPMENT of proper techniques in the moulding of sponge rubber has been studied by a certain mid-western rubber company in consultation with Chrysler Corporation. Among the materials used in the experiments in curing the sponge, were moulds of glass (pyrex), wood, and fibre. Pyrex glass seemed to present the best electrical and structural qualifications. Maple wood was employed for test but found to be undesirable; moisture content varied, and warpage of moulds occurred. Excessive heating of the



# NEW TELECHRON TRIUMPH

**1-RPH MOTOR  
for  
slow-speed  
timing  
and  
control**

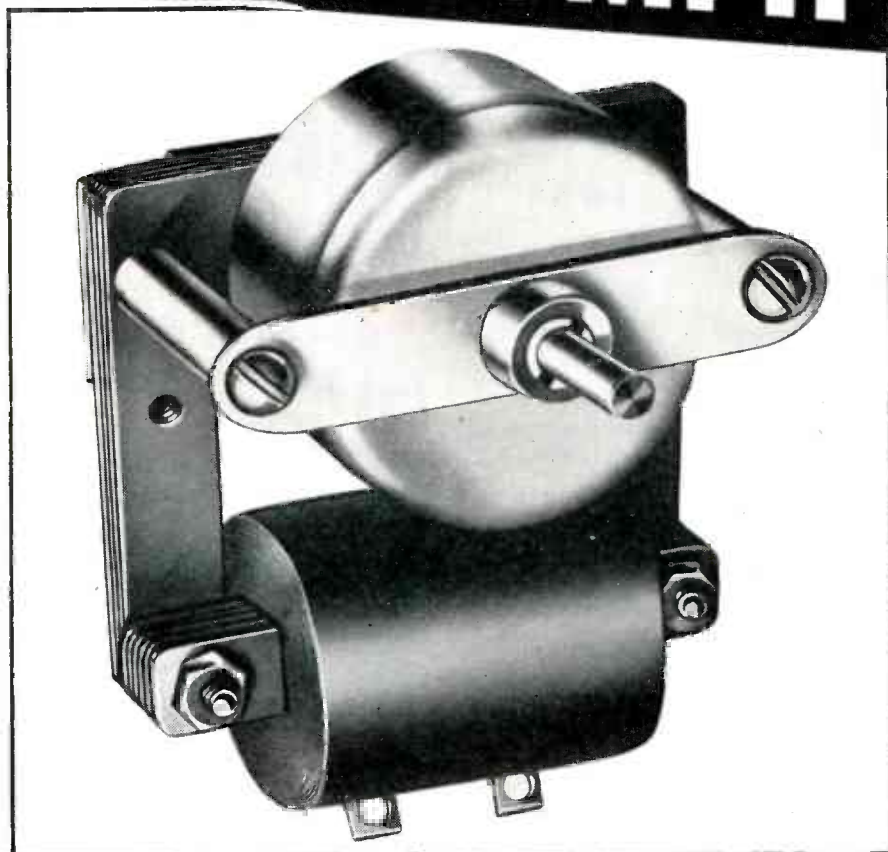

## COMPANION MODEL

Another new slow-speed Telechron motor. Eccentric terminal shaft at the 12 o'clock position in respect to the outer case. Can be furnished at speeds of from 3 rph to 6 rph.

**F**OR TIMERS . . . thermostats . . . oil burner and coal stoker controls . . . and other apparatus in which minimum space and slow speeds are necessary . . . here's a new, smooth-running, accurate Telechron motor with a shaft speed of 1 REVOLUTION PER HOUR.

Designed to answer the demands of control manufacturers, this new Telechron motor is **TOTALLY ENCLOSED**, comes in a sealed case, has a special life-extending oil gland built into the terminal shaft bearing. With an input rating of 2 watts, and with terminal shaft concentric with the outer case of the motor, it is precision-built to bring you Telechron accuracy, dependability, and long service under industrial and domestic operating conditions. Can also be furnished in other speeds up to and including 6 revolutions per hour.

Production samples of the 1-rph motor (and its companion model at left) will be available soon. For full details on how you can use these slow-speed motors in your timers or controls . . . or for facts on our many other synchronous self-starting motors for instrumentation . . . write to Motor Advisory Service, Dept. C. Our 25 years' experience is at your service.

*Telechron*

REG. U. S. PAT. OFF.

**WARREN TELECHRON COMPANY, ASHLAND, MASSACHUSETTS**  
MAKERS OF TELECHRON ELECTRIC CLOCKS AND SYNCHRONOUS ELECTRIC MOTORS

# SYLVANIA NEWS

ELECTRONIC EQUIPMENT EDITION

AUGUST Published by SYLVANIA ELECTRIC PRODUCTS INC., Emporium, Pa.

1945

## HIGH FREQUENCY INDUCTION FURNACE USED IN TUBE PLANT

The bombardier or high frequency induction furnace pictured below is another example of high-precision, modern equipment manufactured at Sylvania Electric's plant in Williamsport, Pa.

### Flexible in Application

Used in all radio tube plants where exhaust machines operate, this essential apparatus may also be adapted for use in practically any application that requires high frequency induction heating by the connection of the proper heating coils. Its rated input is 25KVA, uses Type 207 tube as oscillator, frequency about 300KC.



High frequency induction furnace used in all radio tube plants where exhaust machines operate. Made by Sylvania Electric at Williamsport, Pa.

## LOCK-IN TUBES PERFECTLY IN LINE WITH RECENT FCC DECISION

*High Frequency Sets (FM) Will Get Benefit of Tubes' Electrical Superiority*



### THE "LOCK-IN" TUBE

- 1 It is "locked" to socket—solidly.
- 2 It has short, direct connections—lower inductance leads and fewer welded joints.
- 3 Metal "Lock-In" locating lug—also acts as shield between pins.
- 4 No top cap connection... overhead wires eliminated.

Sylvania Electric's revolutionary type of radio tube—the Lock-In—is so mechanically stronger and electrically more efficient that it takes in its stride the recent FCC decision assigning to frequency modulation the band between 88 and 106 megacycles. The basic electrical advantages of the Lock-In construction are ideally suited to the adoption of higher frequencies.

Mechanically it is more rugged because support rods are stronger and thicker—there are fewer welded joints and no soldered joints—the lock-in lug is metal not molded plastic—the ele-

ments are prevented from warping and weaving.

Electrically, it is more efficient because the element leads are brought directly down through the low loss glass header to become sturdy socket pins—reducing lead inductance—and interelement capacity.

Today, the many special features of the Sylvania Lock-In Tube are even more up-to-date than when they were introduced in 1933—a fact of increasing importance when considering the numerous postwar developments in the field of communications.

# SYLVANIA ELECTRIC

Emporium, Pa.

MAKERS OF RADIO TUBES; CATHODE RAY TUBES; ELECTRONIC DEVICES; FLUORESCENT LAMPS, FIXTURES, WIRING DEVICES; ELECTRIC LIGHT BULBS

# PIONEERS OF THERMOPLASTIC INSULATION

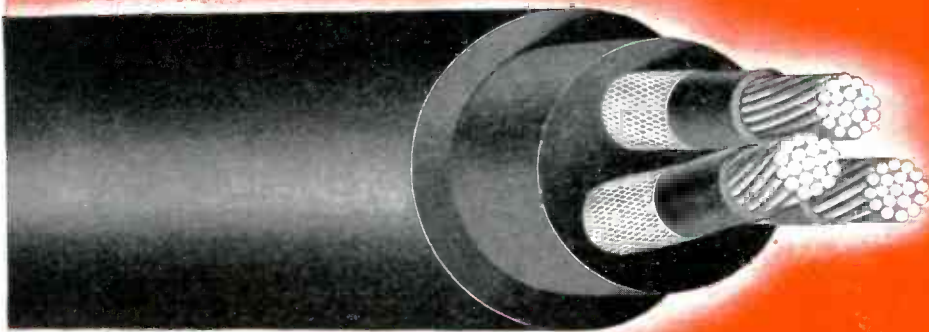

Thermoplastic insulation specialists . . . producing a complete line from fine wires to heavy power cables . . . serving: Public Utilities, Radio, Electronic, Appliance and Instrument Manufacturers, Telephone Companies and Contractors.

There are few, if any, other fields in which thermoplastics are solving more problems . . . or accomplishing more fundamental changes in industrial design . . . than in the insulation of wire and cable. Demand today the increased resistance which these new compounds and constructions offer to heat, flame, oxidation, chemical action, oil, grease, moisture, cold, abrasion, fungus growth and other severe conditions. Write NOW for complete information and samples engineered to your particular requirements. Remember . . . when you're thinking of PLASTIC you're thinking of US!

# PLASTIC

W I R E & C A B L E *NORWICH CONN*



C O R P O R A T I O N



## Something New for the RECORD

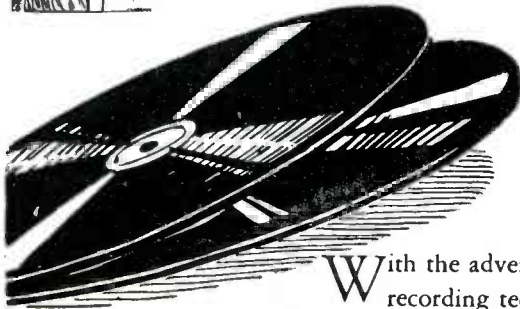

With the advent of new plastics and recording techniques, phonograph records of tomorrow will be pressed in finer-grain, noise-free materials. Recordings, however, can be no better than the pickup arm used in their reproduction. It remained for The Astatic Corporation, therefore, to design a new pickup with advanced characteristics equaling those of the new recordings. This has been accomplished by Astatic through improved featherweight action made possible with the introduction of vertical compliance and new damping materials. The greatest possible fidelity of sound reproduction from these advanced products, so dependent upon each other, will result, therefore, in an ever increasing measure of phonograph enjoyment. Production will begin when essential materials are made available.

**"You'll HEAR MORE  
from Astatic"**

ASTATIC Crystal Devices  
manufactured under Brush  
Development Co. patents.

**THE**  
*Astatic*  
**ASTATIC CORPORATION**  
CONNEAUT, OHIO  
IN CANADA. CANADIAN ASTATIC LTD., TORONTO, ONTARIO

wood resulted. Fibre was tried with poorer results than with wood. Suggestions of using resin impregnated glass cloth developed nothing usable.

Experiments made on the rubber showed that it had a dielectric constant of 2.6, power factor 0.004, and loss factor 0.0008. Attempts to find a material of the same dielectric constant, power factor and loss factor as the material being heated, and that would have no distortion under heat and pressure, were disappointing.

### *Conventional Moulds*

The moulds experimented with were cup moulds of the standard design used in curing by conduction. They were made in the form of a cup with a cover of the same material, and the electrodes placed above and below the mould.

With the conventional type of steam or electrically heated curing moulds, the curing cycle may range from 30 minutes to as much as three hours, depending on the amount of mass and the temperature used. The external surface of the charge being in contact with the heated mould suffered prolonged exposure to curing temperature with minimum cure in the center of the mass. Cellular structure was difficult to control with conduction heating.

Dielectric heating offered the possibility of a maximum of three minutes to attain uniform curing temperature throughout the entire mass. Cellular structure, therefore, would be uniform with a minimum temperature gradient through the mass.

### *First Method*

Sponge rubber was poured into the moulds and r-f power applied at 8 megacycles,  $7\frac{1}{2}$  kva maximum output. The electrodes were placed above and below the closed glass container. At the start of the cycle, the container was partly filled, leaving an air gap between the charge and the upper electrode. Heat concentration in the sidewalls of the container developed. Due to the rapid temperature rise possible, a temperature gradient of large magnitude was established between the center and outer sidewall portions



**"WILL YOU RUSH THESE WIRES?"**

"LET ME KNOW BY WIRE!" "In answer to your wire!" You hear it everywhere, and this use of *wire* for *telegram* is tribute to the almost incredible network of wires by which Western Union serves the nation. And few facts in turn, speak so eloquently of the dependability of VINYLITE plastic wire and cable insulation as its widespread adoption by Western Union.

Among many applications in its offices, this great communications

leader uses instrument wire with VINYLITE plastic primary insulation, and no outer covering. Such wire forms the connections on distributing frames and switchboards. It is used on stationary apparatus and carriages in motion, and has better heat resistance than former materials. But wherever used, inside or out, Western Union has found the thin-wall construction of VINYLITE plastic insulation of outstanding value. Its extreme flexibility, re-

sistance to aging, flame, moisture, abrasion, and most chemicals bring new standards of life and performance.

Specify VINYLITE plastic insulation for your own applications. Write Department 18 for your copy of "VINYLITE Plastics for Wire and Cable Insulation."

BAKELITE CORPORATION  
 Unit of  
 Union Carbide and Carbon Corporation  
 30 EAST 42ND ST., NEW YORK 17, N.Y.

# Vinylite Plastics

TRADE-MARK

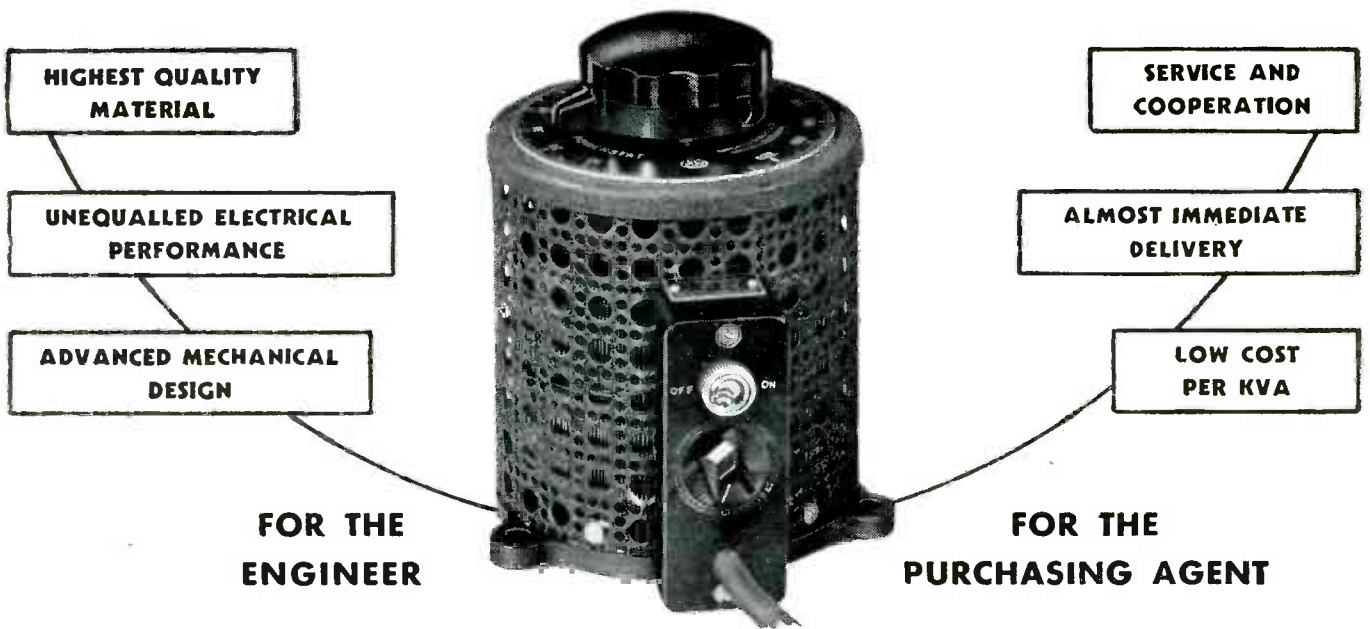

## REASONS for investigating POWERSTAT

No matter what capacity in the range of 1 to 100 KVA a specific voltage control application requires, the POWERSTAT variable transformer selected for the job will offer more advantages to both the engineer and purchasing agent than any other type of voltage controller. A typical example is POWERSTAT type 116 illustrated. Constructed of the highest grade materials, built to exacting standards, and possessing unequalled electrical characteristics; this POWERSTAT assures the user of maximum performance. When operated from a 115 volt line, it will deliver an output voltage variable from 0 to 135 volts. In contrast to units of other manufacture its rated output current of 7.5 amperes is a continuous rating and is available at any output voltage. Although of greater capacity, POWERSTAT type 116 is lighter and has the same mounting dimensions as other units of comparable size. Of special interest to the purchasing agent is the almost immediate delivery feature.

Detailed technical information can be obtained in bulletins 116 LE and 149 LE.



THE ENGINEER



THE PURCHASING AGENT

*Send for Bulletins*

# SUPERIOR ELECTRIC COMPANY

407 LAUREL STREET

BRISTOL, CONNECTICUT

# IT'S THE **VARNISH** THAT *Insulates!*

A VALID REASON FOR SPECIFYING  
**FIBERGLAS** TUBING AND SATURATED SLEEVING  
BY IRVINGTON

To obtain *all* the advantages a Fiberglas base insulation can provide, *look to the varnish used, and its method of application.* It's the firm, continuous varnish film which supplies the high insulating values.

In the manufacture of Irvington Fiberglas tubing, the *right* varnish can be used for every application . . . one which will penetrate the interstices and by its bonding action prevent chafing of the fibers, and supply the required dielectric strength, resistance to aging, and other qualities which make for efficient,

lasting insulation. For IRVINGTON is headquarters for Insulating Varnishes.

And in the application of the varnish, you are assured of the same precise laboratory and manufacturing control that has kept IRVINGTON the undisputed leader in electrical insulation.

Thus when you order IRVINGTON Fiberglas tubing, sleeving, or cloth, you get all the advantages a glass base can provide, *and in full measure.* For full details write to Department 106.

#### OTHER IRVINGTON FIBERGLAS PRODUCTS:

Varnished Fiberglas Cloth  
Laminated Varnished Fiberglas Slot Insulations  
Varnished Fiberglas-and-Fiber Slot Insulations  
Varnished Fiberglas Tubings and Saturated Sleeveings  
— *also a complete line of standard varnished insulations and insulating varnishes.*

"LOOK TO IRVINGTON  
FOR CONTINUED  
LEADERSHIP IN  
INSULATION"



**IRVINGTON**  
VARNISH & INSULATOR COMPANY

Irvington 11, New Jersey

**Industrial Condenser  
Corporation's  
NEW HOME**



**THE WORLD'S MOST  
MODERN CONDENSER PLANT  
with these outstanding features**

- ★ 1,000,000 VOLT RESEARCH LABORATORY
- ★ VERY LATEST PRODUCTION EQUIPMENT
- ★ SPECIALIZED WAR-LEARNED TECHNIQUES

From this NEW ultra-modern factory come capacitors carefully engineered and accurately produced. Staffed by skilled engineers and backed by 16 years of technical progress, Industrial Condenser Corp. is supplying capacitors for every application. If your specifications call for Electrolytic, Paper, Oil, or Motor capacitors, look to Industrial Condenser Corporation.

**INDUSTRIAL CONDENSER  
CORPORATION**

3243-65 NORTH CALIFORNIA AVENUE, CHICAGO 18, U. S. A.  
District Offices in Principal Cities

**PAPER, OIL AND ELECTROLYTIC MOTOR CAPACITORS**

resulting in thermal strains and stresses developing beyond the elastic limits of the pyrex glass.

*Revised Mould*

Suggestion was made to build the mould from available material with characteristics not too dissimilar from the charge. The mould qualifications were to be dimensionally stable under varying temperatures and pressures. Electrical characteristics so that too high a temperature as to burn the rubber surface, or too low a temperature so as to retard surface cure, would not be experienced. Pyrex glass was again used and a restraining wall of two by four by four inches internal dimension, open at each end was employed.

An aluminum electrode sheet placed on a slab of insulating material formed the base with the restraining form placed on this. The upper electrode consisted of two units. One was made the same size as the lower electrode and the other slightly smaller than the charge chamber. The second electrode was attached to the larger electrode by small compression springs allowing the charge electrode to enter the charge chamber and rest on the upper surface of the charge mass.

*Results*

As the temperature increased in the charge, the charge increased in size, which, due to the restraining walls of the form, allowed the mass to increase only in thickness. The work electrode was pushed against its springs toward its parent electrode until it reached its stop gages, placed to control the maximum size of the charge. The container walls were heated by the energy flow from the parent electrode to the base electrode. Due to a much greater distance between the electrodes than between the charge electrode and the base electrode, the container never attained a temperature greater than the charge.

The physical characteristics of the charge were such that as the temperature increased the cell structure became larger, increasing the distance between electrodes at this point. Stabilization was automatically controlled, as no portion



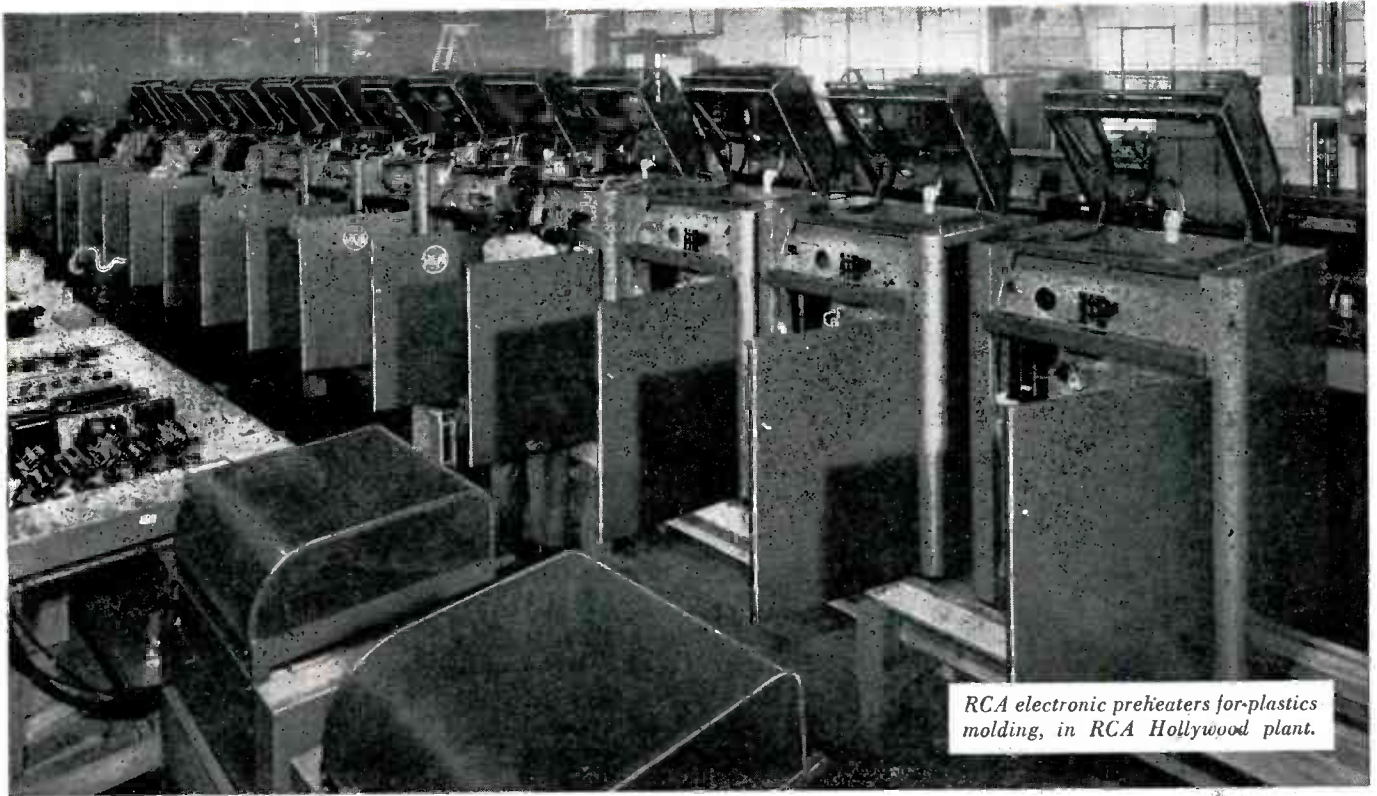

*RCA electronic preheaters for plastics molding, in RCA Hollywood plant.*

# QUICK DELIVERY ON RCA ELECTRONIC PREHEATERS

**Users Report Production Increases up to 500%; Plant Output Stepped Up with Present Presses**

**I**F you have stiff delivery schedules to meet . . . if you're having trouble with high rejections . . . if mold damage causes you frequent shut-downs . . . if you need to mold thick sections or larger-than-normal pieces—then it will pay you to investigate RCA electronic preheating. *RCA electronic generators for plastics molders are available for quick delivery!*

**Why So Many Advantages?** Electronic preheating is the fastest, most effective

method of thoroughly plasticizing preforms before insertion in the press. High-frequency electricity—generated by electron tubes—affects every particle of the molding material, simultaneously. Thus, both inside and outside of the material receive heat at the same rate. Heating is usually completed in 60 seconds or less.

This high speed and uniformity of heating mean that the molding compound is put in the press at ideal plasticity—before hardening can begin. Press closing is faster; mold pressure is reduced; flow into the mold cavity is complete—even in intricate molds: pressure against inserts is reduced; hard cores are eliminated, thus preventing mold damage; sticking in the

mold is often relieved; curing time in the mold is reduced greatly; and residual stresses which cause warping, cracking, or dimensional changes are virtually eliminated.

The reduction in the time-cycle, on the average, makes possible a 50% increase in output per press; reduction of rejects frequently increases this gain—sometimes as much as 10-fold.

The uniformity of preheating makes it possible to mold larger pieces; and the high temperature attained in preheating makes molding of thick sections (over  $\frac{3}{8}$  inch) commercially practical.

**Your Application:** Regardless of your molding problem, RCA engineers urge you to investigate electronic preheating. Send your problem to them for free consultation. The "Data Form P" offered in the coupon will help you supply the necessary information. Address: Radio Corporation of America, Electronic Apparatus Section, Box 70-194H, Camden, N. J.

**RCA  
ELECTRONIC  
HEAT**



**BUY  
WAR  
BONDS**

**RADIO CORPORATION  
OF AMERICA**

RCA VICTOR DIVISION, CAMDEN, N. J.

**SEND THIS TODAY FOR QUICK REPLY**

**RCA, Electronic Apparatus Section, Box 70-194H, Camden, N.J.**

Please rush me free data on the completely automatic RCA electronic preheater, Model 2B, which is especially designed for Plastics Molders. Also send "Data Form P."

Name .....

Company .....

Position .....

Address .....

City ..... Zone ..... State .....

70-6236-194



No. 1025-6  
18" x 9" x 9"



No. 1025-1  
12" x 6" x 6"

*Made to your order... and ready now!*

## SPARE PARTS BOXES

As per specifications 42B (Int) for shipboard use. Electrical and Mechanical. Navy grey finish. Immediate delivery.

SPECIAL SIZES MADE TO ORDER . . . 24 STOCK SIZES

Number	Length	Width	Height	Number	Length	Width	Height
1025-1	12	6	6	1025-13	18	18	12
1025-2	12	9	6	1025-14	30	15	12
1025-3	12	12	6	1025-15	24	15	12
1025-4	12	9	9	1025-16	24	15	15
1025-5	18	9	6	1025-17	24	18	12
1025-6	18	9	9	1025-18	24	18	15
1025-7	18	12	9	1025-19	24	18	18
1025-8	18	6	6	1025-20	24	12	9
1025-9	18	15	9	1025-21	42	9	9
1025-10	18	12	6	1025-22	36	12	9
1025-11	18	15	12	1025-23	30	15	9
1025-12	18	12	12	1025-24	42	12	9

WRITE FOR PRICE LIST

# COLE

STEEL EQUIPMENT COMPANY

349 Broadway, New York 13, New York • Factory: Brooklyn, New York

No. 1025-14  
30" x 15" x 12"  
(Partitions not included)



**Cole Steel  
office equipment  
will again be available  
after the war**

# N-Y-T can put a finger...

## ON YOUR TRANSFORMER REQUIREMENTS



★ The illustrated unit typifies the many hermetically-sealed components—transformers, chokes and filters—designed to meet unusual operating conditions for every type of application.



**—with emphasis on electrical and mechanical suitability!**

The N-Y-T Sample Department has demonstrated its ability to continuously supply advanced transformer, choke and filter designs for most electrical and electronic needs. In every instance, all requirements are fulfilled efficiently, and economically.

Let us take care of any samples you may need for new equipment being designed.

*Inquiries are invited; address Dept. E*

**NEW YORK TRANSFORMER CO.**  
26 WAVERLY PLACE, NEW YORK 3, N. Y.

# HICKOK

## Water Proof, Moisture Proof and Steam Proof METERS



**VOLTMETERS . . . AMMETERS . . . MILLIAMMETERS . . .  
MICROAMMETERS . . . WATTMETERS . . . BOTH AC AND DC**

Now, you can get HICKOK precision and dependability in a new line of hermetically sealed meters. Available in 2½", 3½" and 4¼" round styles. Dimensions of American War Standards Assn. Drawings C39.2-1 and C39.2-2. The 4¼" size is built especially for use in radio service equipment where several scale arcs are required.

All instruments are hermetically sealed and both vacuum and pressure tested under water. Case fabricated of pressed steel and made corrosion resistant to meet specifications. Terminals are a special glass soldered-in type.

All meters are fully shielded, permitting use on either magnetic or non-magnetic panels. Operation is accurate and dependable even up to 85° centigrade. Internal pivot construction in D.C. types assures longer life and greater resistance to shock and vibration. Write for further information today.

**THE HICKOK ELECTRICAL INSTRUMENT CO.**  
10527 DUPONT AVENUE . CLEVELAND 8, OHIO

PRECISION CALIBRATED . . . LASTING ACCURACY

MOULDING SPONGE RUBBER (continued)

of the charge would heat much more than another. Gradually diminishing temperature rise as the cycle progressed and the electrodes traveled apart was another feature of this fixture that proved very desirable.

. . .

### Sandpaper Made by Electrostatic Process

ELECTRONIC RECTIFIERS and an electrostatic process of coating paper with abrasives have produced a sandpaper which is found to increase cutting efficiencies from 20 to 60 percent, resulting in economies of 30 to 40 percent for the average job.

In the electrostatic process responsible for this product, the abrasive particles, sifted to size as in the past, are fed from a hopper to an endless belt. This belt carries them over the negative side of a pair of closely-opposed electrodes between which a high-tension electrostatic field is set up, through the action of a unidirectional potential of around 50,000 volts, supplied by vacuum-tube rectifiers. Under the positive or upper electrode, with its glue-covered surface facing the granules on the belt, the backing passes on its way to the drier.

#### *Effect on Particles*

As the abrasive particles pass into the electrostatic field, they are oriented so that they stand on end, and at approximately equal distances from each other. The force of the field then translates them along the lines of force toward the other electrode. Here they are firmly imbedded in the adhesive.

The sandpaper resulting from this process has a coating in which the abrasive grains stand on end, with their sharp points facing outward toward the work. These grains are also securely set at approximately uniform distances from one another.

Electrocoated sandpaper is being marketed with coatings of garnet, silicon carbide, and aluminum oxide, in standard grit numbers from "fine" to "coarse" and with backings of cloth, paper, or combinations.

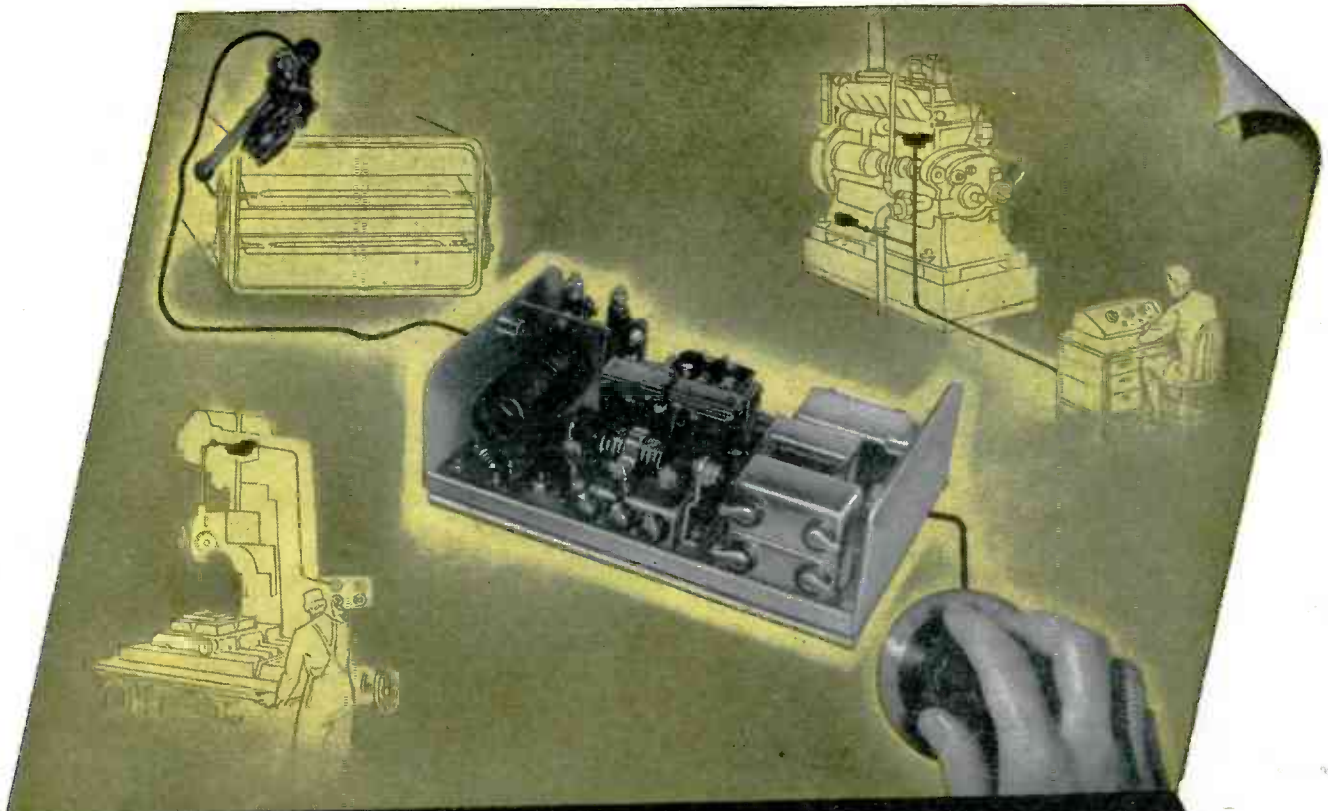

# IT SAYS "WHERE"

Suppose you want a distant valve turned just so far—or a machine tool to be precisely controlled—or any of thousands such adjustments taken care of.

This is achieved with Lear Remote Controls—precise electrical devices which regulate the motion to just what is ordered. In other words, you set the dial at what you want and the control takes over and says exactly "where."

Where it is an advantage, the control may be set to respond automatically to changes in temperature, position, pressure or speed. There are more instances where

such controls are needed in industry than we can mention—or that we even know of. Perhaps you have an application now where one would save you time, money and expense or perform a function hereto impossible.

If you have, please write and let us know. While our engineers are applying these controls to war needs, they will be glad to discuss your problems with you.

**LEAR,**  
INCORPORATED  
PIQUA, OHIO

formerly Lear Avia, Inc.



LEAR, Incorporated  
Dept. 81  
Piqua, Ohio

Gentlemen:  
Please send me your  
free booklet showing  
Lear equipment and its  
many applications.

Name \_\_\_\_\_

Address \_\_\_\_\_

City \_\_\_\_\_ State \_\_\_\_\_

SELENIUM



COPPER  
SULPHIDE

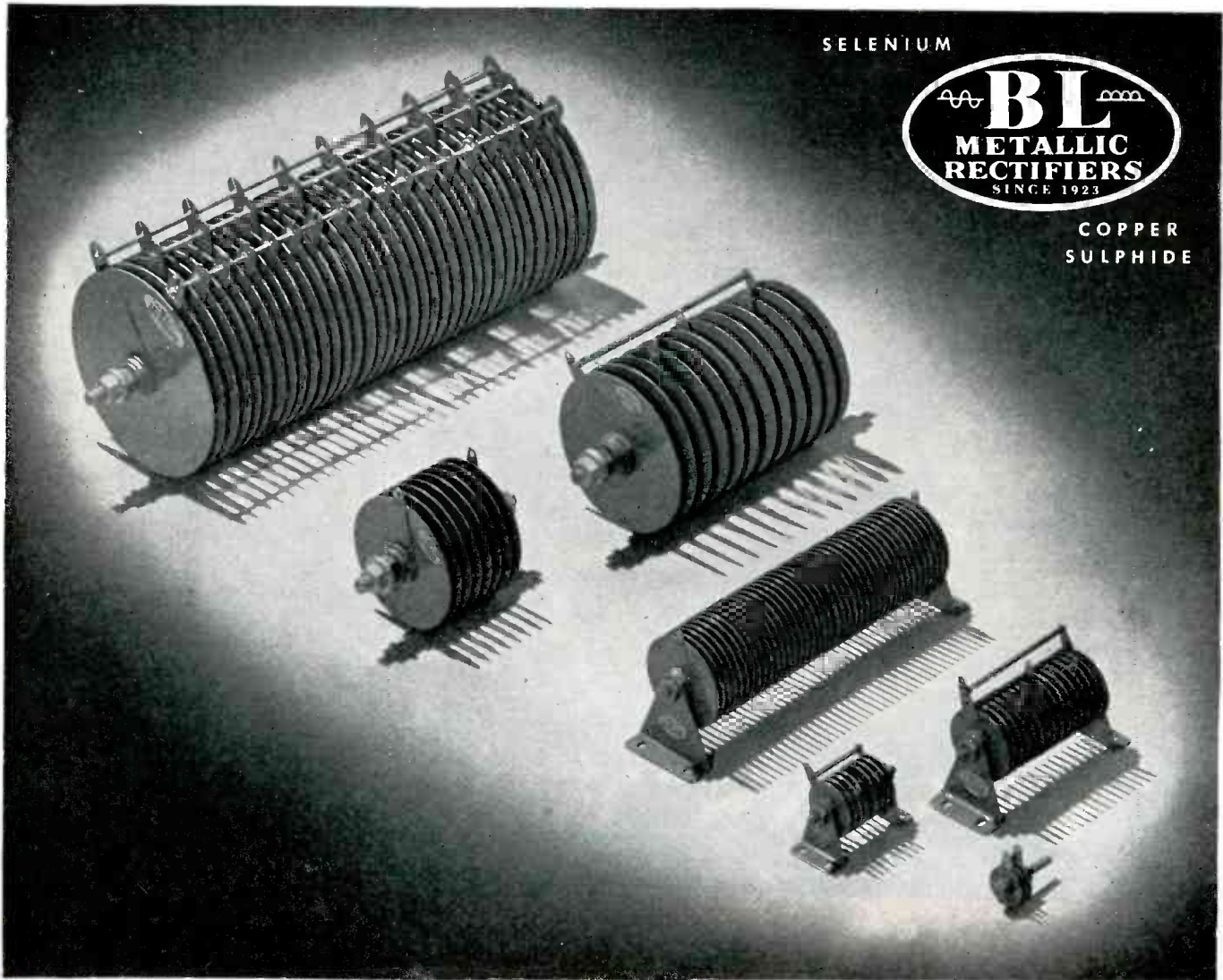

## B-L METALLIC RECTIFIERS from Milliwatts to Kilowatts

If you have an A. C.-D. C. conversion problem, let B-L engineers help you. We have successfully produced many appliances formerly thought impractical.

B-L Metallic Rectifiers have been favorably known to the electrical industry for many

years. They are reliable, efficient, designed to get *your* job done right!

No matter what rectifier applications you are considering, B-L will be glad to work with you. Selenium and Copper Sulphide Rectifiers for all needs are available.

*Write today for Bulletin R-41-a.*

SELENIUM



COPPER  
SULPHIDE

THE BENWOOD-LINZE COMPANY

1815 Locust Street . . . . . St. Louis 3, Mo.

Long Distance Telephone CEntral 5830

New York Sales Office:

420 Lexington Ave., New York 17, N. Y., Murray Hill 5-5878

Chicago Sales Office:

20 N. Wacker Drive, Chicago 6, Illinois, CEntral 2379

*Designers and Manufacturers of Selenium and Copper Sulphide Rectifiers,  
Battery Chargers, and DC Power Supplies for practically every requirement.*



FREQUENCY SHIFTER FS-12A-1

## FREQUENCY SHIFTERS by PRESS WIRELESS

This electronic device affords a new system for greatly improved radio transmission of Morse telegraph, teleprinter, photo and facsimile signals as proved by thousands of operating hours in actual service.

The distinctive functional design of FREQUENCY SHIFTER FS-12A-1 is based upon exclusive developmental research in Press Wireless laboratories.

Available in strict priority sequence.

Write for free  
ENGINEERING  
BULLETIN  
describing  
Frequency Shift  
Operation  
and its advantages.

# PRESS WIRELESS, INC.

Executive and Sales Office, 1475 BROADWAY, NEW YORK 18



Awarded to our Hicksville, L. I. plant for outstanding achievement in war production.

PARIS · BUENOS AIRES · RIO DE JANEIRO · MONTEVIDEO · MANILA · BERNE · SANTIAGO DE CHILE · NEW YORK · CHICAGO · LOS ANGELES · LONDON · HAVANA

# TUBES AT WORK

A D-C Amplifier of High-current, Low-impedance Output.....	212
Combination Instrument for Direction Finding.....	214
High-Speed Code Recording.....	230
Multi-Channel High-Speed Communications by Radio.....	238

## A D-C Amplifier of High-current, Low-impedance Output

By LAWRENCE FLEMING  
Naval Ordnance Laboratory  
Washington, D. C.

THE PROBLEM of making a d-c amplifier which will deliver a large current to a low-impedance load is difficult to solve by conventional means. Ordinarily the load of a d-c amplifier must be connected directly in the space-current path of the last tube, because a matching transformer cannot be employed. Power tubes require at least 100 volts between plate and cathode in order to conduct sizeable currents; when the drop across the load is but a few volts the efficiency of the system becomes very low. If output currents of more than about 200 milliamperes are needed, an inconvenient number of large tubes in parallel must be used.

Direct-current driving amplifiers are often required for oscillographic work. The amplifier here described delivers up to one ampere to an oscillograph element of three ohms impedance, with a frequency range of zero to several thousand cycles. Since it was clearly impractical to parallel enough power tubes to conduct one ampere (several channels were required), the expedient was employed of using a carrier-current system terminating in an output transformer and a dry-disc rectifier.

### Performance

Specifications of general interest are: Maximum output, 1.2 amperes into 3 ohms. Input signal for maximum output, 10 volts d-c. Input impedance, 10 megohms. Frequency range, 0 to 4000 cycles.

The linearity of the input-output relation is shown in Fig. 3. The stability is high and the system operates for months at a time without adjustment.

Figure 1 shows the system in

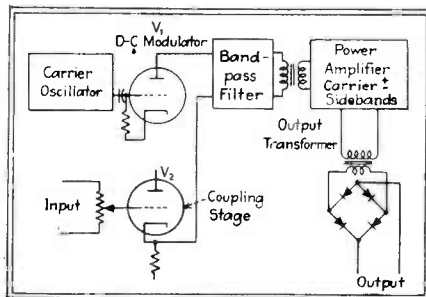

Fig. 1—Functions of the several stages of the oscillator-amplifier arrangement for supplying up to one ampere of direct current to a three-ohm load

block-diagram form. An oscillator supplies carrier excitation to the grid of modulator tube  $V_1$ . This tube is operated as a class C amplifier, so that its carrier-frequency output is proportional to its plate voltage. The plate voltage of tube  $V_1$  is supplied by the d-c input signal through a cathode follower  $V_2$ . The carrier frequency output of modulator tube  $V_1$  passes through a bandpass filter which passes the carrier frequency and

the sidebands, thence through a power amplifier, an output transformer, and a dry-disc rectifier. The d-c output of the system is taken from the rectifier.

### Modulator Circuit

The class C type of modulator used has a higher order of stability than the more conventional diode, varistor, or square-law type of balanced modulator. To minimize the residual carrier voltage appearing at the output of the modulator when its plate voltage is zero, the modulator stage may be neutralized, or it may be operated as a frequency multiplier without neutralization. In practice, the latter is simpler and just as effective.

The best tube for use as a modulator is a high- $\mu$  triode. The excitation voltage is not critical. Operating constants for the modulator in the system shown are: Grid excitation, 20 volts. Plate voltage operating range, 0 to 10 volts. Load (filter) impedance, 7500 ohms.

### Details of Circuit

Figure 2 is a schematic diagram of a complete amplifier channel. The modulator tube  $V_1$  is biased conventionally by means of grid leak  $R_1$  and capacitor  $C_1$ . The no-signal plate voltage of  $V_1$  is adjusted by potentiometer  $P_1$ , which permits utilizing input signals of either polarity. The cathode follower  $V_2$  is here arranged to drive the cathode of  $V_1$  instead of the plate. A negative signal at

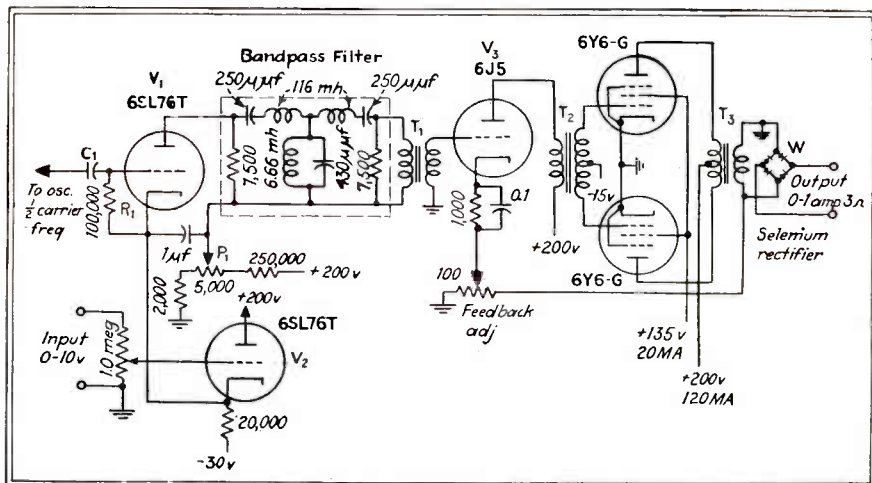

Fig. 2—Complete circuit of the direct-current amplifier. Use of a carrier-current system provides one ampere d-c output without using several tubes in parallel to conduct such a large current



# relays

## FOR REMOTE RECORDING

It is often desirable to tie in the operation of two or more pumps with a single level control, or to coordinate the operation of several pumping stations and reservoirs. In such cases, complete pump, valve, and level control systems may be supervised by the Builders Chronofix Telemeter, which, by remote control, (using Guardian Relays) automatically registers temperature, pressure and flow by a three pen graph writer and on a flow totalizer unit. Chronofix units are also used for weight control of materials handled on belt conveyors and for other purposes.



## Relays BY GUARDIAN

This application demonstrates one of the most popular uses of the Guardian Series 40 Relay—its use as a magnet (without contacts). Its function is to control two clutches which govern the movement of the pen arms.

Since this is a continuous operation the relay must be exceptionally well built. It must also be compact in design to fit within the allotted space. The Series 40, having a laminated core and armature, draws a minimum of current and provides more power than a relay with a solid core and armature. This recommends it for continuous duty applications. Its small size and stud mounting permit quick and easy assembly within a confined space.

NEW GUARDIAN CATALOG describes the Series 40 and dozens of other relays, solenoids, steppers, magnetic contactors and switch parts. Write for it on your business letterhead.

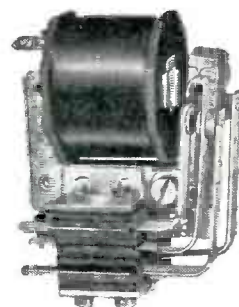

SERIES 40 A. C. RELAY

**GUARDIAN**  **ELECTRIC**  
1625-J W. WALNUT STREET CHICAGO 12, ILLINOIS  
A COMPLETE LINE OF RELAYS SERVING AMERICAN INDUSTRY



*Post-War Performance!*

**Permoflux Midget Transformers Conserve Vital Space and Weight!**

• Because of their exceptional operating efficiency and uniform frequency response characteristics, Permoflux midget transformers have literally hundreds of practical applications where size and weight are determining design factors. Developed by Permoflux engineers, with new materials and manufacturing methods, they are available unshielded, shielded or hermetically sealed for your specific requirements. Why not let us design a unit for you?

**Permoflux Speakers Assure the Best in Tone Reproduction**

Their wide frequency response, extreme sensitivity and rugged mechanical design have established new concepts of tone realism. Permoflux speakers in sizes from 2" to 15", with power handling capacities from 1 to 20 watts, are available for your post-war developments.

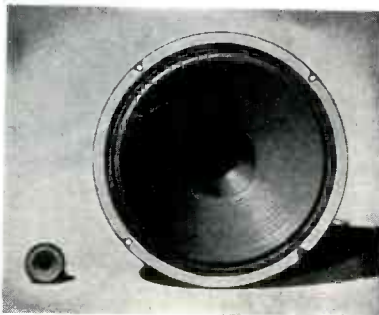

TRADE MARK  
**PERMOFLUX**

**PERMOFLUX CORPORATION**  
4900 WEST GRAND AVE., CHICAGO 39, ILL.



**PIONEER MANUFACTURERS OF PERMANENT MAGNET DYNAMIC TRANSDUCERS**

the grid of  $V_2$ , thus increases the voltage between the plate and cathode of  $V_1$ .

The bandpass filter should pass the carrier frequency and the upper and lower sidebands. If the percentage bandwidth is small, a tuned circuit can be substituted for the filter.

In this particular case, an overall response of 0 to 4000 cycles was required. The carrier frequency chosen was 30 kilocycles. The filter was designed for a nominal bandwidth of 25 to 35 kilocycles.

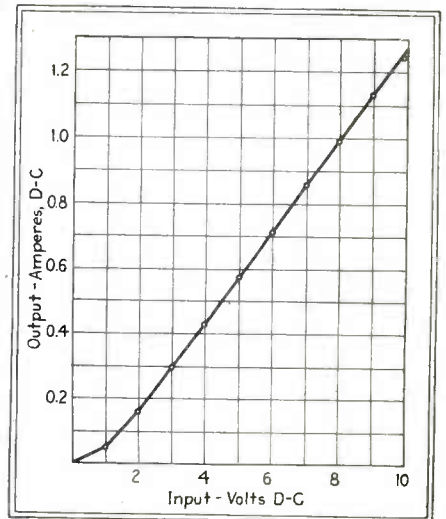

Fig. 3—Input-output characteristics of the direct-current amplifier

Because of the high carrier frequency, special transformers had to be built for use at  $T_1$ ,  $T_2$ , and  $T_3$ . At 10 kilocycles and below, ordinary audio transformers should be satisfactory.

The rectifier  $W$  at the output of the system is a Federal selenium unit, type 5B1AV1. At 30 kilocycles, the efficiency of dry-disc rectifiers is about half that obtained at lower frequencies. Hence if a lower maximum frequency of overall response is usable, a lower carrier frequency can be employed with a consequent reduction in the size of the power amplifier.

A twelve-channel amplifier of the type described has given satisfactory service for over a year.

• • •

**Combination Instrument for Direction Finding**

AN AIRCRAFT NAVIGATIONAL aid recently designed by the Marconi



# *Light?* We call it "LIGHT FANTASTIC"!

**... a transformer headed for 65,000 feet "altitude" ... at 350 degrees temperature!**

And to top it off, it had to be "lighter than anything on the market," \*they said. What, we asked, was it for? They couldn't tell us, and we don't know to this day, but we do know it was badly needed.

"It has to operate not only on a 60-cycle current at ground level, but from 400 to 2600-cycle current, and what's more, at a simulated altitude of 65,000 feet."

Thermador built this special transformer equipment. It passed the above mentioned requirements. That wasn't enough. They gave it another test, in which they changed the temperature from ambient (the temperature of a fairly warm room) to 350—in two hours. It passed that test, too. This is all we know of one of the most mysterious jobs

we ever did, in the not-mysterious method in which we built all of our transformers.

\*For reasons of military security names cannot be given.

BUY WAR BONDS

**THERMADOR  
TRANSFORMERS**  
DEFEAT HEAT • COLD • HUMIDITY



**THERMADOR ELECTRICAL MANUFACTURING CO.**  
5119 SOUTH RIVERSIDE • LOS ANGELES 22, CALIFORNIA

*In the palm of your hand...*



*An Alert Organization...*  
**equipped to produce YOUR TUBES  
under YOUR BRAND name!**

It's like adding a complete new plant to your own manufacturing facilities when you assign the important job of electronic tube production to *Lewis at Los Gatos*. Here is every facility . . . machinery, skill of highly trained personnel, engineering brains, and enthusiasm! For efficient and economical production of your tubes, manufactured to your "specs," call Lewis Electronics!

*Lewis at Los Gatos*

A manufacturing organization . . . the pride of an entire community . . . with an electronic engineering background of 20 years experience! Plus a war-born performance record of meeting huge production demands and exacting technical requirements—on time and economically!

*Let us tell you about the war or post-war job Lewis can do for you! Write, phone or wire and our representative will personally call!*

**Lewis** ★ **ELECTRONICS**  
LOS GATOS • CALIFORNIA

# ENGINEERED INSULATORS

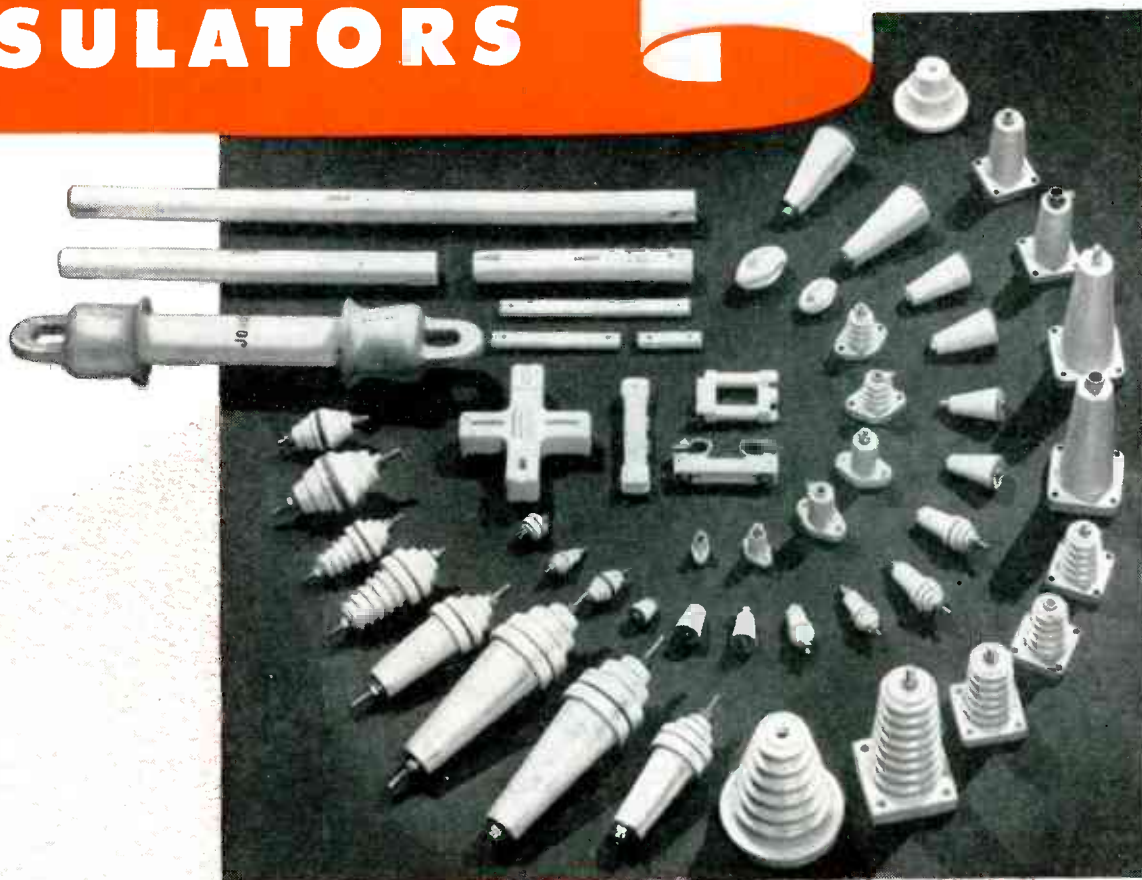

Johnson Radio Engineers have been specialists in insulator design for radio frequencies for almost a quarter of a century. Shapes to provide strength for strains and stresses—reinforced mounting holes and carefully designed mountings—high internal resistance to radio frequency voltage—long leakage path—careful treatment to present a surface that will not collect dirt and foreign matter—quality

hardware, not punched nuts and poorly formed parts—materials selected for their radio frequency characteristics, not the ordinary variety of ceramics. To Johnson Engineers an insulator is a piece of radio apparatus and given the same careful attention in design and production. As a result you can't buy a better insulator than Johnson. Your radio-electronics parts jobber stocks Johnson insulators.

*Ask for catalog 968-D*



# JOHNSON

*a famous name in Radio*

E. F. JOHNSON COMPANY • WASECA • MINNESOTA

Here's a soldering iron with . . .

**HEAVY  
POWER**  
(225 WATTS)







**LIGHT  
WEIGHT**  
(14 OUNCES)

made possible by  
**KWIKHEAT'S  
BUILT-IN  
THERMOSTAT**

- ★ HEATS IN ONLY 90 SECONDS
- ★ MAINTAINS PROPER HEAT
- ★ CAN'T OVERHEAT
- ★ LESS RETINNING NEEDED
- ★ TIPS LAST LONGER
- ★ COOL, SAFE HANDLE
- ★ LIGHT WEIGHT

The Kwikheat Soldering Iron has ample reserve power for your soldering jobs—225 watts held in check by a thermostat built right into the iron\*—maintaining ideal temperature for perfect soldering—preventing overheating (which causes deterioration in other irons)—prolonging life of tips and eliminating the need for constant retinning. Besides these big advantages, the Kwikheat Iron is hot, ready to use only 90 seconds after plugging in. It is extremely light (14 ounces), well-balanced, and has a safe, cool handle. No wonder Kwikheat is a sensation wherever it is used. Ask your jobber. With choice of #0, 1, 2, or 3 tips. **\$11.00**

**6 INTERCHANGEABLE TIP STYLES**

					
#0	#1	#2	#3	#4	#5
\$1.25	\$1.25	\$1.25	\$1.25	\$1.75	\$1.25

VANATTA

*Kwikheat*  
**THERMOSTATIC SOLDERING IRON**  
A Division of  
Sound Equipment Corp. of Calif. • 3903 San Fernando Rd., Glendale 4, Calif.

Wireless Telegraph Co. incorporates in one unit the several instruments normally used to determine a radio bearing. True bearing may be read directly from a cursor, with automatic correction for sense.

Electronically switched cardioid reception is used and an output meter indicates in which direction the aircraft should be turned in order to obtain an on-course setting. The tubes which perform the switching are in turn operated by means of a low-frequency oscillator.

Tubes V-1 and V-2 (see Fig. 1) are dual-function triode-hexodes, in which the triode portions are con-

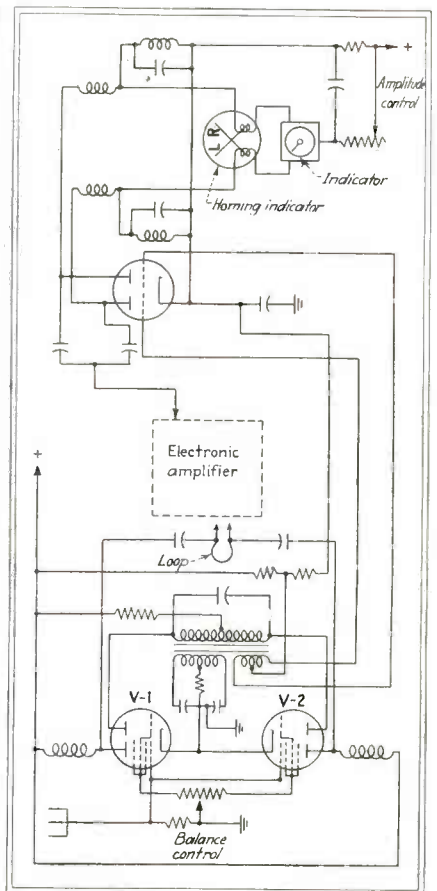
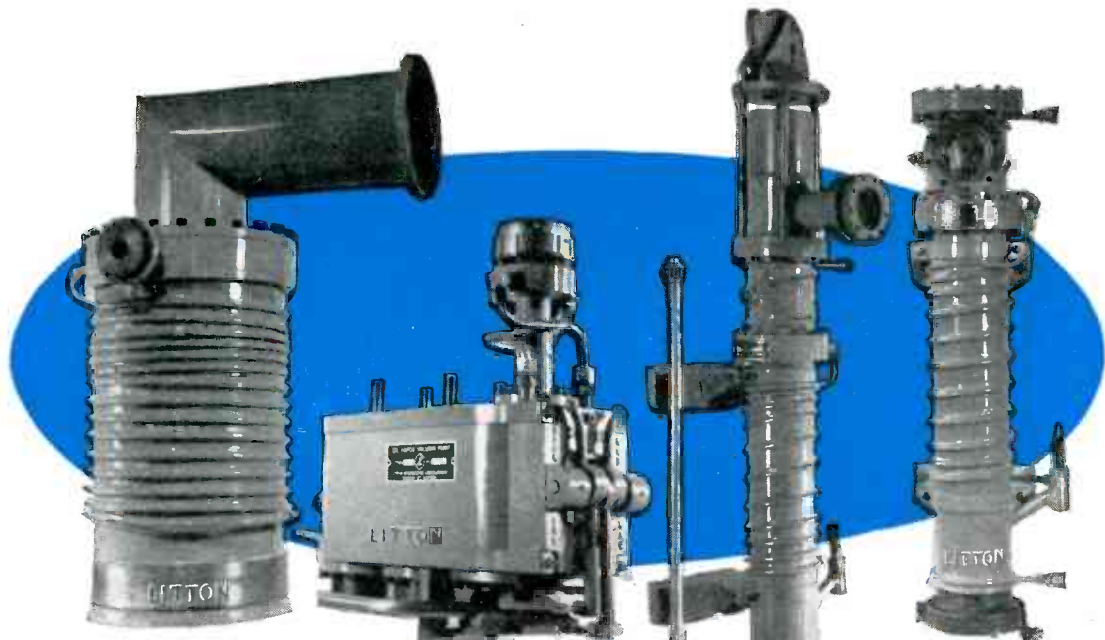

FIG. 1—Functions of the several stages of the Marconator, a British navigational aid for aircraft that combines several d-f instruments into one

nected to form a push-pull low-frequency oscillator, so that when the grid of V-1 is positive the grid of V-2 is negative. Both hexode portions of the tubes have their input grids connected together and the input from the vertical antenna is fed to this point, the anodes being connected differentially to the loop



**MODEL S**  
Height 29½ inches  
Weight 100 lbs. (approx.)

**MODEL T**  
(A Complete Exhaust System  
With High and Low Vacuum  
Valve and Charcoal Trap)  
Height 11½ inches  
Weight 17½ lbs.

**MODEL R**  
(With Valve and Charcoal Trap)  
Height 38¾ inches  
Weight 40 lbs.

**MODEL P**  
(With Charcoal Trap)  
Height 24¼ inches  
Weight 31 lbs.

## What you may expect from LITTON

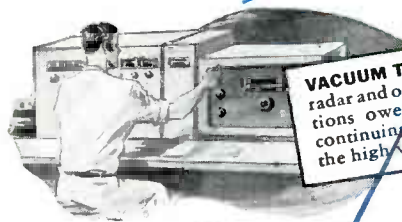

**VACUUM TUBES** for radio, radar and other communications owe their existence, continuing improvement to the high vacuum pump.



**HIGH VACUUM** has made possible the efficient processing of penicillin, foods, vitamins, etc.



**LABORATORY RESEARCH** in many fields to create new and useful products requires the use of high vacuum.

**OIL VAPOR VACUUM PUMPS.** Litton All Metal Vapor High Vacuum Pumps are specifically designed to serve a wide variety of high vacuum uses such as manufacturing all types of vacuum and gas filled tubes . . . heat treating and vacuum casting of metals . . . petroleum industrial applications . . . processing of pharmaceuticals and chemicals. Litton pumps serve scientists and technicians who today are creating tomorrow's world of induction heating, electronic controls and other wonders.

Designed by engineers experienced in high vacuum installation for many years, Litton pumps reach their maximum efficiency in a very short time. Their sturdy, compact structure insures lower installation costs, higher vacuum and longer life. The easily demountable boiler and charcoal baffle and the low cost, long lasting Litton Molecular Lubricant provide greater economies in operation and maintenance.

Litton Engineering service is available for all high vacuum installations or problems. Catalogs will be furnished upon request.

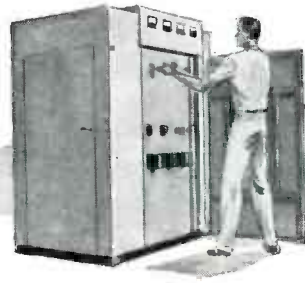

Many metals and alloys used in warfare and modern industry are refined under high vacuum.



# Litton

**ENGINEERING LABORATORIES**

**REDWOOD CITY, CALIFORNIA, U. S. A.**

# FOSTER TRANSFORMERS

## AVAILABLE NOW!

Facilities for peacetime manufacture of transformers are already available at A. P. Foster, and, as war commitments are filled, will be increasingly at your service.

During the war years A. P. Foster has supplied thousands of custom-designed and custom-built transformers to all branches of our armed services, for use in all parts of the world under great extremes of climatic condition.

High production schedules have been maintained by advanced Foster manufacturing techniques. High standards of performance were demanded, achieved and will be maintained—to the benefit of America's peacetime economy.

As your own reconversion plans advance from the conference stage to the blueprint stage, it may well be worth your while to bear in mind that Foster engineers and designers are ready now to consult with you on every transformer problem and to furnish estimated costs and delivery schedules on experimental or quantity production of standard transformers or special jobs custom-built to your own specifications.

- BOB REID, 810 West 57th Street, Indianapolis 5, Ind., Telephone Broadway 2725
- BAUMAN AND BLUZAT, 2753 West North Avenue, Chicago 47, Ill., Telephone Humbolt 6809-10-11-12
- THE A. P. FOSTER COMPANY, BARRETT BORDER, 11 W. 42nd St., New York 18, N. Y., Telephone PENnsylvania 6-9123

SPECIALISTS IN BUILDING TRANSFORMERS SINCE 1938

# A. P. FOSTER COMPANY

TRANSFORMER ENGINEERS & MANUFACTURERS

719 WYOMING AVENUE, LOCKLAND 15, OHIO (SUBURB OF CINCINNATI)



# START WITH WHISTLER ADJUSTABLE DIES TO REDUCE MANUFACTURING COSTS

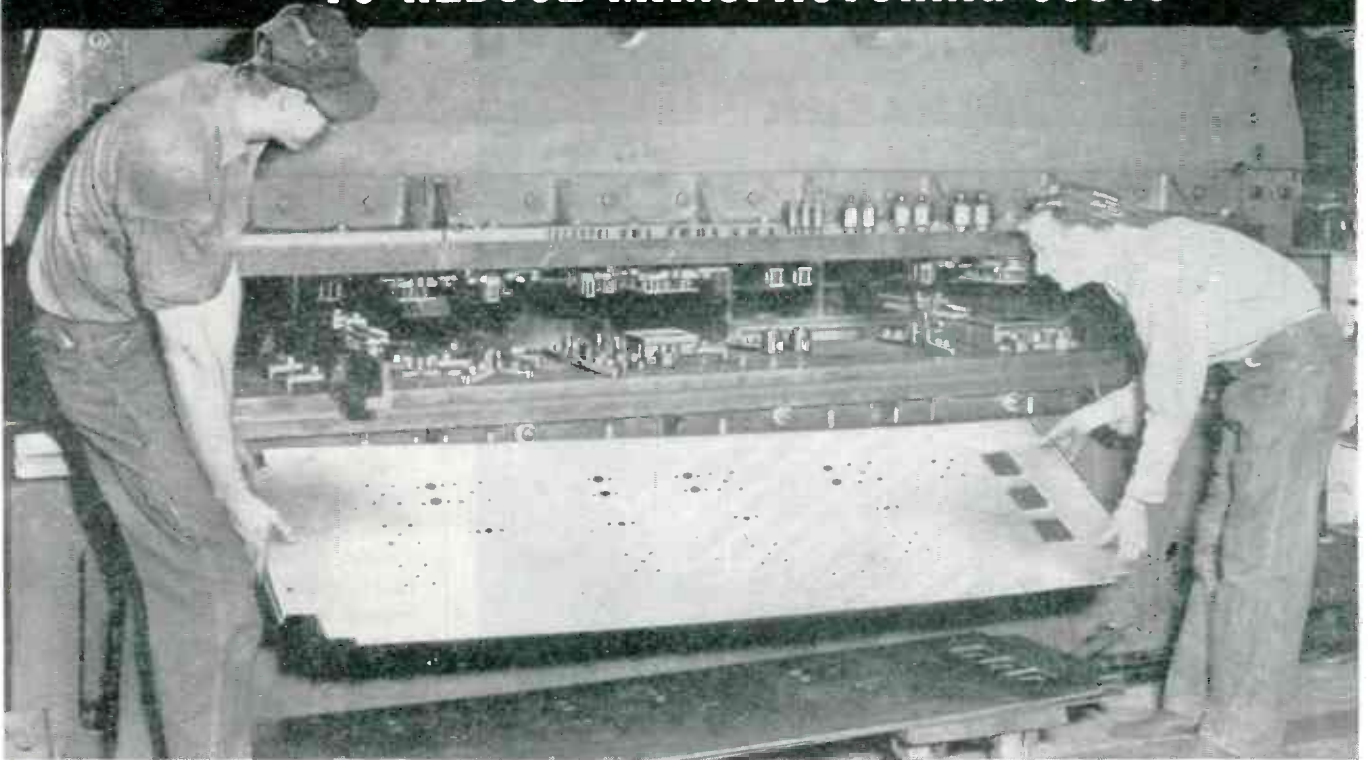

PHOTO COURTESY LAGANKE ELECTRIC CO.

If perforating, notching, slitting or rounding dies are used in the manufacture of your products then you should know the time and money saving advantages of **WHISTLER MULTI-USE ADJUSTABLE DIES**



Write for the Whistler Catalogs. Send blueprint or details of your perforating jobs without obligation.

Continued re-use in different groupings, punches and dies from stock in standard sizes and shapes to 1½" diameters, complete interchangeability of all parts, absolute precision in operation, are but a few reasons why Whistler Adjustable Dies are serving top flight manufacturers throughout the country. Work on materials to ¼"

mild steel and in practically every type press. Closer centers reduce press operations. Special sizes and shapes to order in a minimum of time and can be used in combination with stock units. 28 years experience in the development of time and money saving die equipment makes it good sense to get in touch with Whistler.

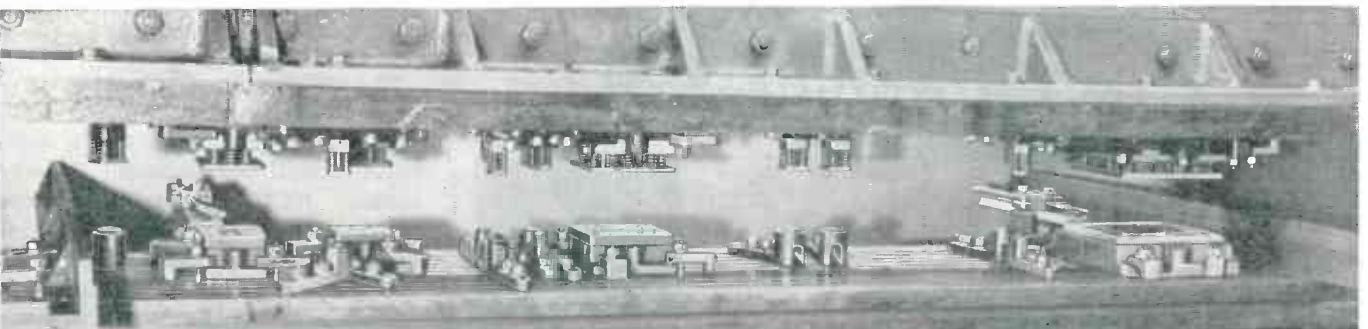

**S. B. WHISTLER & SONS, Inc.**

752-756 MILITARY ROAD  
BUFFALO 17, N. Y.

# DO YOU USE TAPES WITH KNOWN QUALITIES?



## SCOTCH *Electrical* TAPES BRAND Possess Specific Tested Properties

● "SCOTCH" Electrical Tapes are made for insulating, and holding purposes—with backings, adhesive qualities, mechanical and dielectric strengths, corrosion resistance, resistance to heat, moisture or other deteriorating factors, exactly tuned to specific requirements. . . . Know just what "SCOTCH" Tapes are available and what qualities they possess, then you will always be able to select the right tape for every job. Our new illustrated book on SCOTCH Electrical Tapes gives this information. Use the coupon to get your copy today.

★"SCOTCH" is the trade mark for adhesive tapes made in the U. S. A. by M. M. & M. Co.

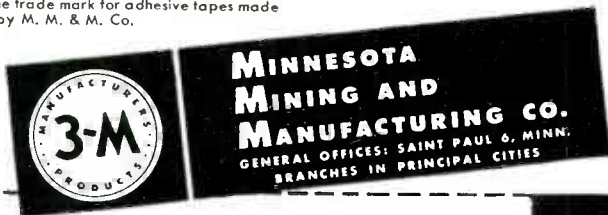

Please send us a copy of your new book on "SCOTCH" Electrical Tapes. E845

Firm \_\_\_\_\_

Street \_\_\_\_\_

City \_\_\_\_\_ Zone \_\_\_\_\_ State \_\_\_\_\_

Signed \_\_\_\_\_ Title \_\_\_\_\_



circuit. If V-1 is amplifying and V-2 is not, the anode current flows in one sense with respect to the loop current and if V-2 is amplifying and V-1 is not, the anode current will be in the opposite sense.

### Off-Course Condition

The visual indicator is operated by a double-triode output tube with two anodes acting as diode anodes. Control of this double triode is by the low-frequency switching voltage which alternately operates the h-f tubes. By the above means, the direction of the rectified currents applied alternately to the visual indicator is directly related to the d-f circuits. Consequently, when the craft is in an off-course position, the needle can be arranged to indicate in which direction the loop should be turned. In practice, the instruction is simple, "Turn the cursor toward the needle."

Called the Marconator (Fig. 2), the unit is contained in a metal case about 7 inches square by 4½ inches deep and housing the following com-

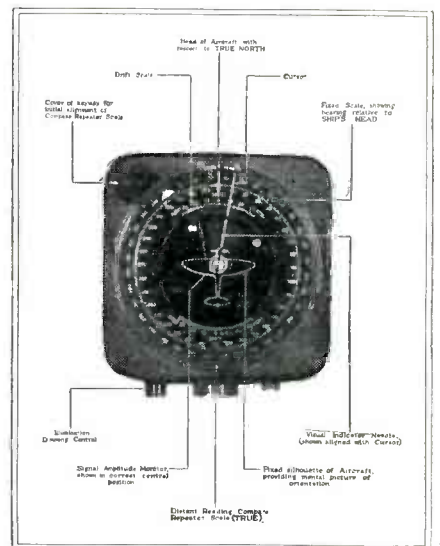
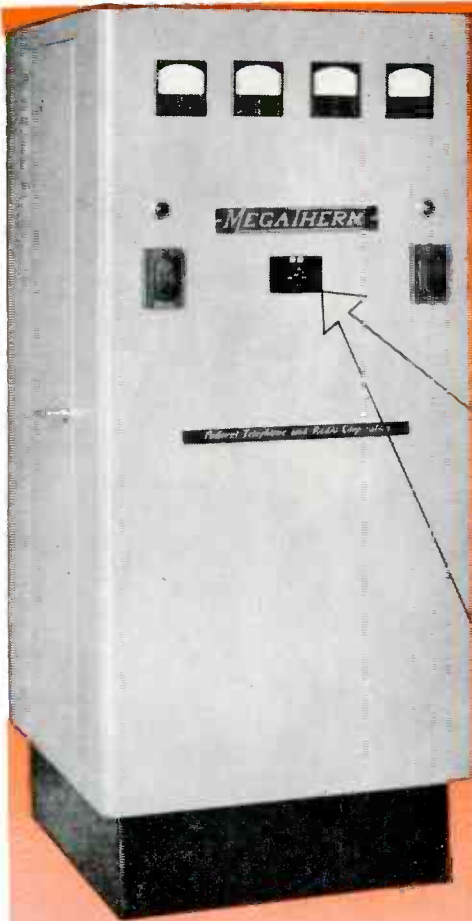

FIG. 2—The several scales of the Marconator are combined into one panel instrument as shown above

ponents: Single-Needle visual indicator, Amplitude indicator, Master cursor, Relative bearing, (True bearing and drift scales), Gyromagnetic distant reading compass repeater motor, Adjustable quadrantal error compensator, and Loop drive mechanism.

Amplitude indication is obtained by an auxiliary movement of the



## "COMPLETE AUTOMATIC PROTECTION OF ELECTRICAL COMPONENTS"

*Says Federal Telephone and Radio Corporation in their Description of the Model MI-3C and MD-3C MEGATHERM For Electronic Induction Heating*

*In Other Words*

# HEINEMANN MAGNETIC CIRCUIT BREAKERS

The MEGATHERM, a piece of equipment for obtaining high speed uniform heating throughout the body of a non-conductor, and for creating quench temperatures to surface-harden steel parts, requires the best that can be had in the way of circuit protection. Valuable units must not be subjected to sudden increase of current due to short circuit or other cause.

Federal Telephone & Radio Corporation engineers, realizing the value of the fully magnetic action of the HEINEMANN CIRCUIT BREAKER, specified it for complete circuit protection. Instantaneous in the case of short circuit, yet with accurately matched time delay to accommodate inrush current and harmless overloads, the HEINEMANN Breaker gives a maximum degree of flexibility of circuit protection as well as absolute safety.

The toggle is plainly marked "ON" and "OFF", avoiding any confusing handle position. It is possible that the HEINEMANN CIRCUIT BREAKER is the answer to YOUR circuit protection problem.

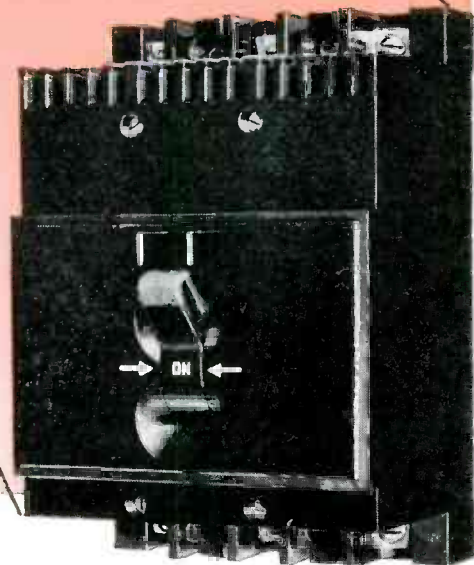

SEND FOR CATALOG—  
SHOWING COMPLETE LINE  
AND ENGINEERING DATA

## HEINEMANN CIRCUIT BREAKER CO.

Subsidiary of Heinemann Electric Co., Est. 1888

97 PLUM STREET

TRENTON, N. J.

# New **ELCO** A1-F RESISTOR 38,500 OHMS

its  
**FUNGUSIZED!**

Temperature coefficient is such that a minus 50° centigrade change in temperature from plus 22° centigrade will produce no greater than plus .01% change in resistance.

A1-F—15/32 long x 1/2" diameter. Mountable with 6-32 flat or filester screw No. 21 Tinned Copper wire leads. 1% standard accuracy. Non-inductive pie wound—1/2 watt, 200 D.C. maximum operating voltage. Fungusized varnish finish.

CAN ALSO BE MADE IN OTHER SIZES  
ACCORDING TO YOUR SPECIFICATIONS

**ALL ELCO RESISTORS ARE PRECISION WIRE-WOUND**

### SPECIFICATIONS:

"A-1"—15/32 long x 1/2" dia.—Mountable with 6-32 flat or filester screw. No. 21 tinned copper wire leads. 1 to 300,000 ohm value—1/2% standard accuracy—non inductive pie wound—1/2 watt, 30° C. temperature rise in free air—100° C. maximum operating temperature—200 D. C. maximum operating voltage. Baked varnish finish.

"A-R"—Same as A-1, with leads reversed.

"B-1"—15/16 long x 1/2" dia.—Mountable with 6-32 flat or filester screw. No. 21 tinned copper wire leads. 1 to 500,000 ohm value—1/2% standard accuracy—non inductive pie wound—1 watt, 30° C. temperature rise in free air—100° C. maximum operating temperature—300 D. C. maximum operating voltage. Baked varnish finish.

"M"—1-13/32 long x 3/4" dia.—Mountable with 6-32 screw—1/8 x .015 thick strap terminals—non inductive wound—1 meg ohm maximum resistance—600 volts maximum operating voltage—100° C. maximum operating temperature—1.5 watts—1% normal accuracy. Baked varnish finish.

"G"—15/32 long x 1/2" dia.—Mountable with 6-32 flat or filester head screw. No. 21 tinned copper wire leads. 1 to 500,000 ohm value. 1/2% standard accuracy—non inductive pie wound .8 watts, 30° temperature rise in free air. 100° C. maximum operating temperature. 200 D. C. maximum operating voltage. Baked varnish finish.

"B-R"—Same as B-1, with leads reversed.

**PROMPT  
DELIVERIES**  
on the New A1-F  
and others described  
and illustrated

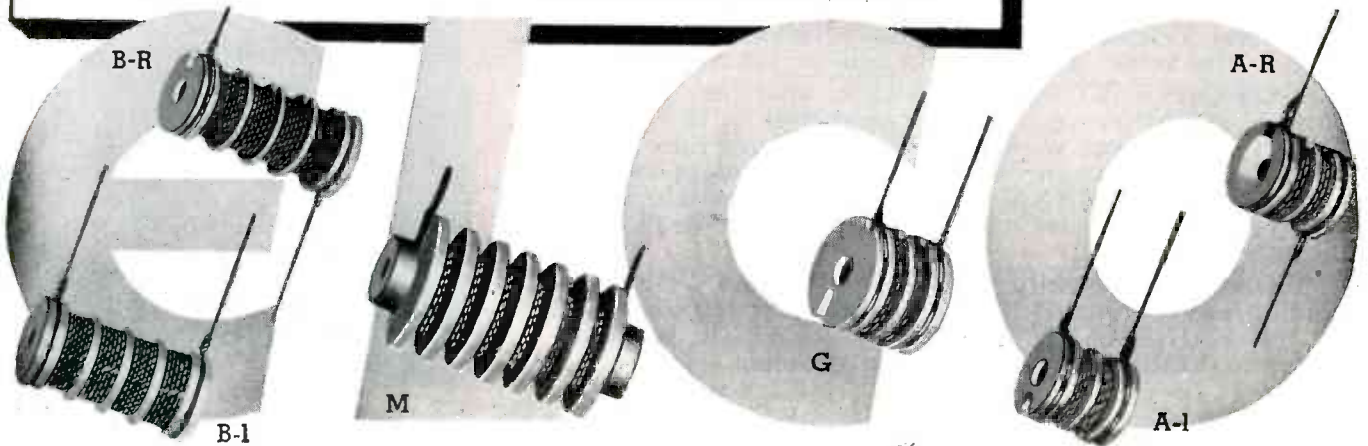

Get to know

**ELCO**

**RESISTORS COMPANY**

114 West 18th Street, New York, N. Y.

Telephone - Watkins 9-4774-5

## YOU ARE READING THE FIRST ADVERTISED DATA ON ZIRMET (FOOTE DUCTILE ZIRCONIUM)

For your guidance in weighing the possibilities of Zirmet (Foote Ductile Zirconium) we present our first advertised physical data on this promising metal.

Please remember that these figures apply only to the product currently available, that there is ample reason to believe these values will be bettered. Quality is improving, production increasing, and price sliding downward, as evidenced by the recent 50% reduction. Additional new data will be released from time to time.

### YIELD STRENGTH

Annealed 29,800 p.s.i.  
Cold Rolled 77,500 p.s.i.

### TENSILE STRENGTH

Annealed 73,000 p.s.i.  
Cold Rolled 111,300 p.s.i.

### HARDNESS

80 Rockwell T30 (on diamond anvil)

### CORROSION RESISTANCE

Corrosion resistant to concentrated HCl, HNO<sub>3</sub>, 50% H<sub>2</sub>SO<sub>4</sub>, 10% NaOH, 50% NaOH at 100°C and H<sub>2</sub>S.

### WORKABILITY

Zirmet can be spot welded, drawn, riveted, crimped, spun, and very easily machined.

### LINEAR COEFFICIENT OF THERMAL EXPANSION

$4.66 \times 10^{-6}$  50° to 600°C

### DROPWISE CONDENSATION

Zirmet exhibits the unusual phenomenon of dropwise condensation (not wetted by aqueous condensates), a characteristic valuable in condensing equipment.

Some forms of Zirmet are available for production; some forms may be obtained for the present in experimental quantities only.

## OURS IS A BIG SMALL WORLD

One of the most essential of the services Foote renders to industry is the grinding of metals, ores and minerals. Raw materials from the remotest corners of the globe come to Foote for processing. The particle sizes in which Foote delivers them can often only be appreciated with the aid of a strong lens. From the big world of resources we make the small world of useful particles.

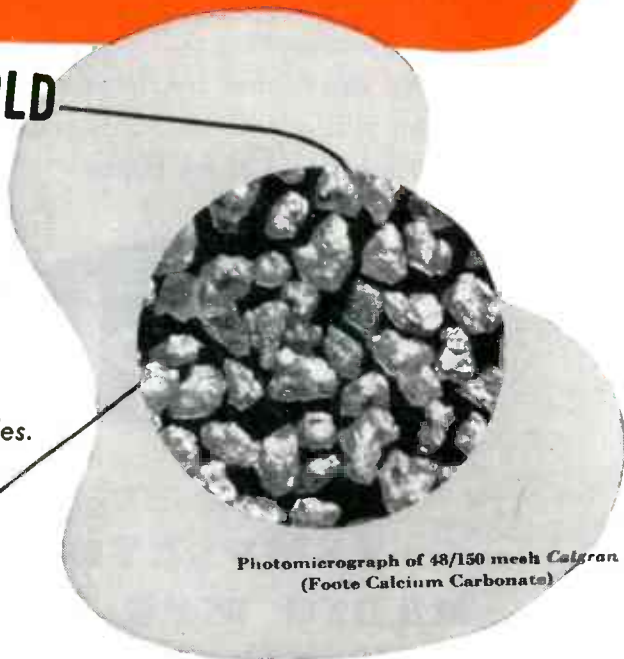
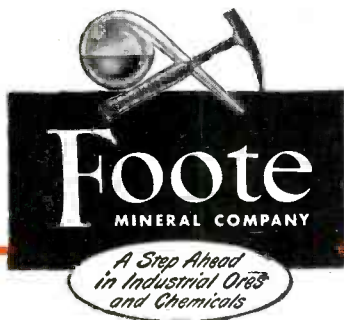

Photomicrograph of 48/150 mesh Calgran  
(Foote Calcium Carbonate)

PHILADELPHIA • ASBESTOS • EXTON, PENNSYLVANIA  
Home Office: 1617 SUMMER STREET, PHILADELPHIA 3, PA.  
West Coast Repr.: Griffin Chemical Co., San Francisco, Calif.



## NEW SECRETS

In the Temple Laboratories, engineers and technicians toil unceasingly to provide new and greater efficiencies for war communications equipment.

Needless to say that out of this constant search for betterment comes further discovery, further knowledge — new secrets of development in the limitless field of electronics.

Temple engineering skill and inventiveness, fostered still further by the stress and strain of war, will contribute richly indeed to the electronic world of the future.



*Electronics Division*

**TEMPLE TONE**  
**RADIO MFG. CORP.**  
 New London, Conn.

flag type, to indicate continuance of transmission and to enable the navigator to maintain sufficient output from the receiver to operate the twin-needle type of homing indicator in the pilot's cockpit.

Remote repetition is by a 3-phase, step-by-step mechanism, geared to the compass scale, control being by a master gyro-compass, but indication relative to it can be made during flight by means of a variation-setting control.

### *Corrections*

Compensation of quadrantal error is normally made with a specially shaped cam, covering symmetrical deviations up to a maximum of 15 degrees. In addition, the mechanism permits the correction of errors due to the loop being fitted on either side of the aircraft's center line (field alignment correction) and also errors due to misalignment of the loop. Where the quadrantal error curve does not correspond to a standard shape, special cams are provided. An example of this is in the well-known Catalina flying boats, on which the d-f loop is mounted near the leading edge of the wing and the fuselage is well below the level of the wing. In this instance the wing produces the predominating influence on the loop, so the sign of the errors is reversed and the shape of the curve generally distorted, owing to the non-symmetrical position of the loop.

### *Gyro Compass*

The gyro-magnetic master compass, with which the Marconator is associated, is a development of the Royal Aircraft Establishment, Farnborough, England. It is a design of particular interest in that it overcomes the airspeed factor, which restricts the operation of the ordinary gyro-compass, by substituting a magnetic compass control for the gravitational control which gives the marine type of gyro-compass its pole-seeking properties. Since this newer gyro-compass can be installed well clear of ferrous material, the magnetic deviation errors are smaller and more consistent than those of the usual compass.

By careful compass adjustment,

# DZUS\*

## SPIRAL CAM FASTENERS SERVE THE ELECTRONIC INDUSTRY

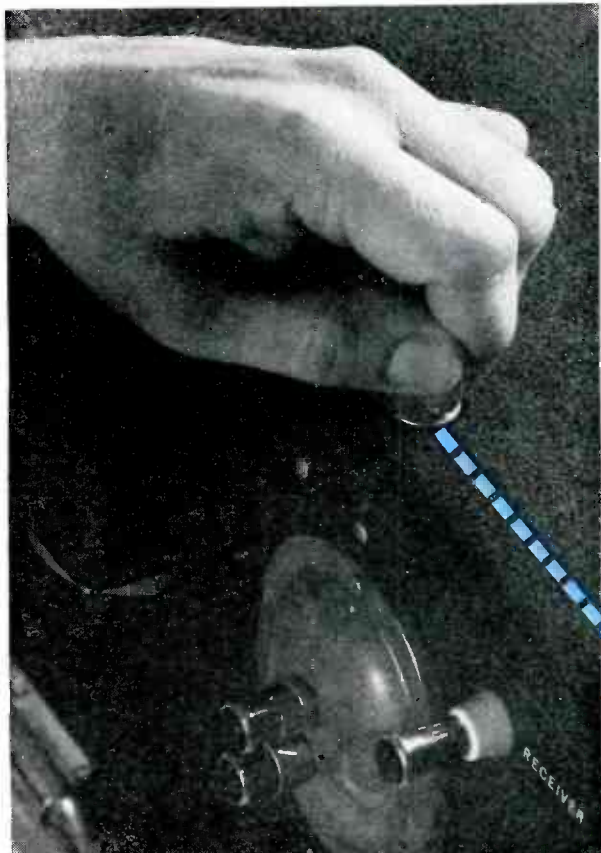

Just a quarter turn with a coin or screw driver and — click — the Dzus spiral cam fastener is firmly locked or quickly unfastened.

Navy's New Collins Autotune Transmitter — the versatile radio used on most two-place and larger types of naval aircraft — is equipped with flush head type Dzus spiral cam fasteners.



Photos, Collins Radio Co.



Flush head fastener stud



Grommet



Spring



Cut-away view of complete Dzus spiral cam fastener assembly

Radio and electronic manufacturers find that quick-acting Dzus spiral cam fasteners have all the qualifications to meet rigid specifications and requirements for firmly holding hinged or removable parts. This fastener is light but rugged, vibration-proof and permanently attached. It is easy to install and operate. It saves valuable time, especially with equipment that requires periodic inspection and adjustment.

There is a Dzus spiral cam fastener for every requirement in the electronic industry — supplied in various sizes and head styles. Send for the Dzus catalog today — and have at your fingertips the most complete line of self-locking fasteners available.

\* The word DZUS is the registered trade mark of the Dzus Fastener Company, Inc.

**DZUS FASTENER COMPANY, INC.**  
BABYLON NEW YORK

IN CANADA: RAILWAY AND POWER ENGINEERING CORP., LTD.

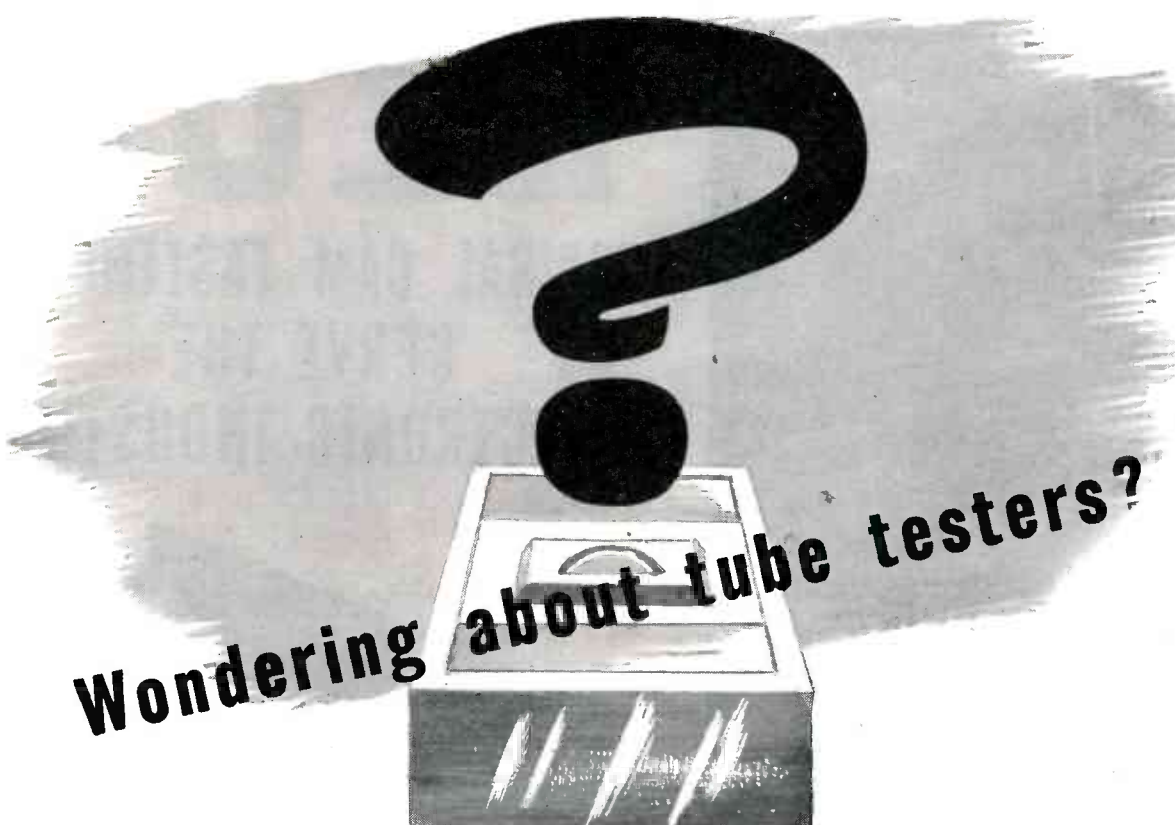

**Wondering about tube testers?**

*...Here's what Simpson has ready  
and waiting for your postwar needs*

**Sensational? Yes . . .**

- 1.** This new Simpson Mutual Conductance Tube Tester tests tubes with greater accuracy than any commercial tube tester ever designed.
- 2.** Provides greater flexibility for future tubes than any other tester.
- 3.** Tests tubes with voltage applied automatically over the entire operating range.
- 4.** Simplifies as never before the interpretation of tube condition from mutual conductance readings.

**Simpson**  
INSTRUMENTS THAT STAY ACCURATE

**SIMPSON ELECTRIC COMPANY**  
5200-18 Kinzie Street, Chicago 44, Ill.

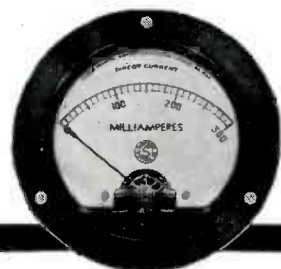



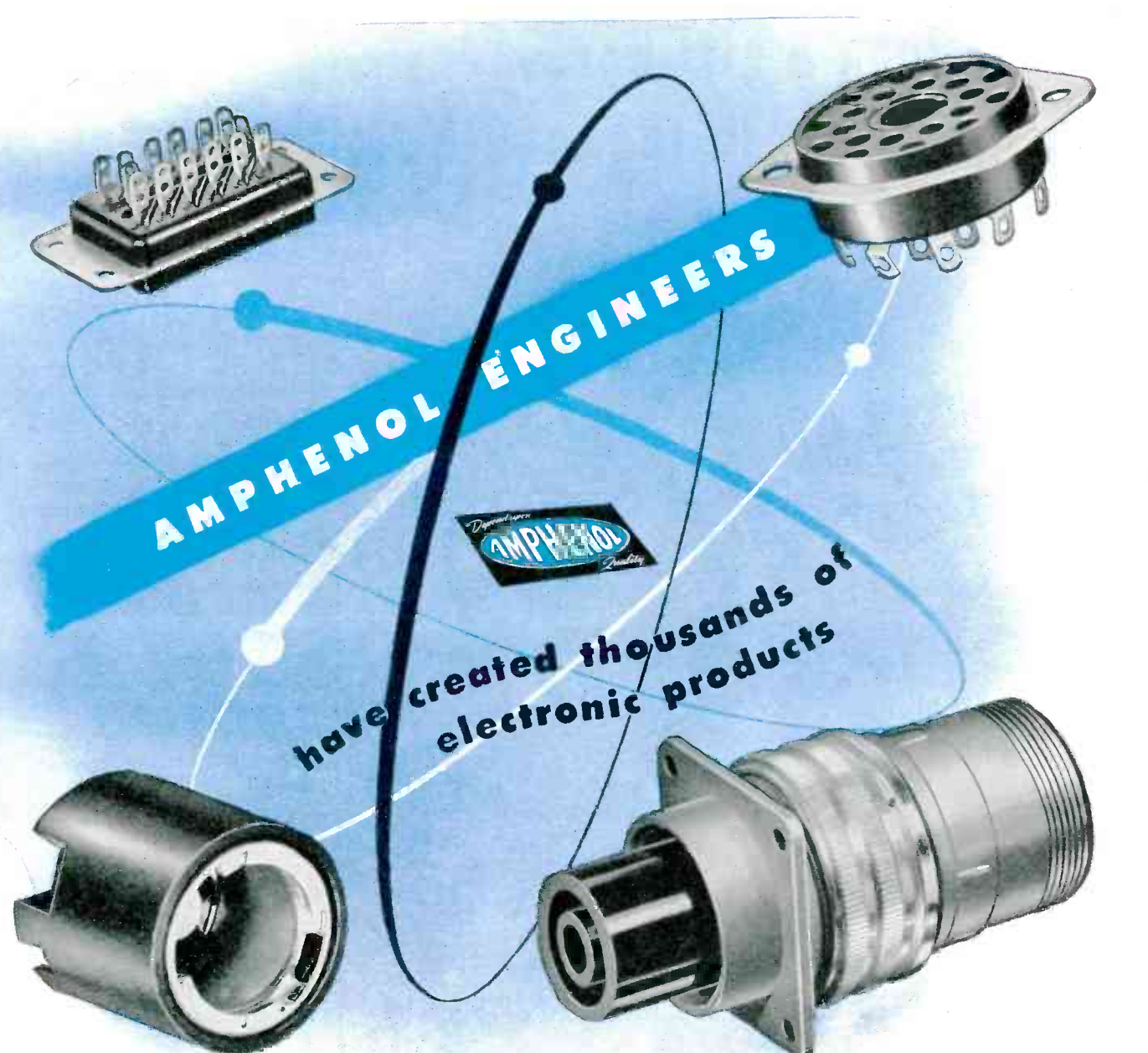

**AMPHENOL ENGINEERS**

*Depend upon*  
**AMPHENOL**  
*Quality*

**have created thousands of  
electronic products**



The versatility of Amphenol engineers is evidenced in the varied electronic applications for which they have designed and produced components. Many of the now standard sockets, connectors and cables produced by Amphenol were originally created to surpass the most exacting specifications.

Products illustrated here are but a few of the thousands of items that comprise the complete Amphenol line including U.H.F. Cables and Connectors, Conduit, Fittings, Connectors (A-N., U.H.F., British), Cable Assemblies, Radio Parts and Plastics for Industry.

Your inquiry regarding the adaptation of standard Amphenol components or designing of special purpose units will receive prompt, careful and confidential consideration.

**AMERICAN PHENOLIC CORPORATION**  
Chicago 50, Illinois  
*In Canada • Amphenol Limited • Toronto*

**U.H.F. Cables and Connectors • Conduits • Fittings • Connectors (A-N., U.H.F., British) • Cable Assemblies • Radio Parts • Plastics for Industry**

# never look a gift horse in the mouth...

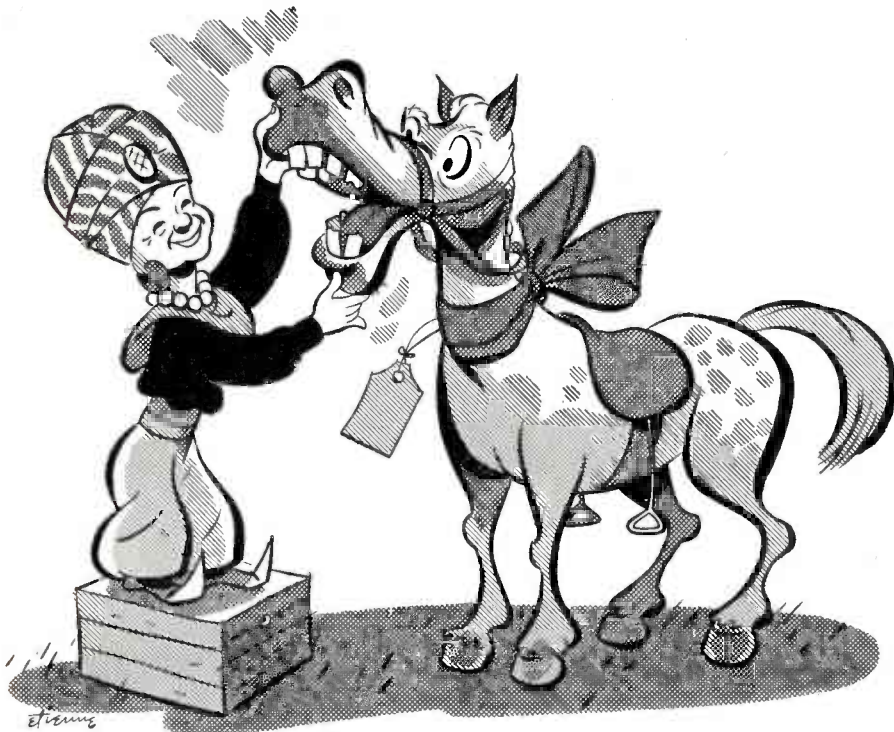

Courtesy may deny too close scrutiny of a gift but certainty demands detailed inspection of a purchase... as in the instance of mica. Be sure it is *Macallen Mica*... standard for more than 50 years!



When you think of MICA think of MACALLEN

**the Macallen Company**  
 16 MACALLEN STREET - BOSTON 27  
 CHICAGO: 355 W. Washington Blvd. CLEVELAND: 2075 Leader Bldg.

the magnetic deviation errors can be reduced to  $\pm 0.5$  deg or less. This, together with the mechanical accuracy of the Marconator of 0.5 deg, gives an overall instrumental accuracy of 1 deg or better. In an actual flight test, 96 out of 100 bearings were within 2 degrees and were each taken in a matter of 10 to 20 seconds by one operator.



## High-Speed Code Recording

RECEPTION OF AUTOMATIC transmissions at speeds as high as 1200 words per minute is provided by an inked-tape recorder that connects directly to any communications receiver or can be used on existing land line installations. Announced by Mecanitron Corp. of Boston, Mass., it operates from a standard 500-ohm input impedance.

The circuit of the unit comprises a high-gain pulse amplifier with a special limiter allowing flat output with an input voltage changing from -5 db to +25 db. On-off key-



Mecanitron recorder that inks out automatic transmissions at speeds as high as 1200 words per minute

ing or frequency shift is provided by front-panel control. When frequency-shift transmissions are to be received, a selective tone discriminator circuit assures noise-free transmission and reception.

The standard frequency-shift stations operating on a difference frequency of 850 cycles can be received; any other frequency-shift separation can be obtained by proper tuning of the input circuit. On-off keyed transmissions are received with the bfo set to produce

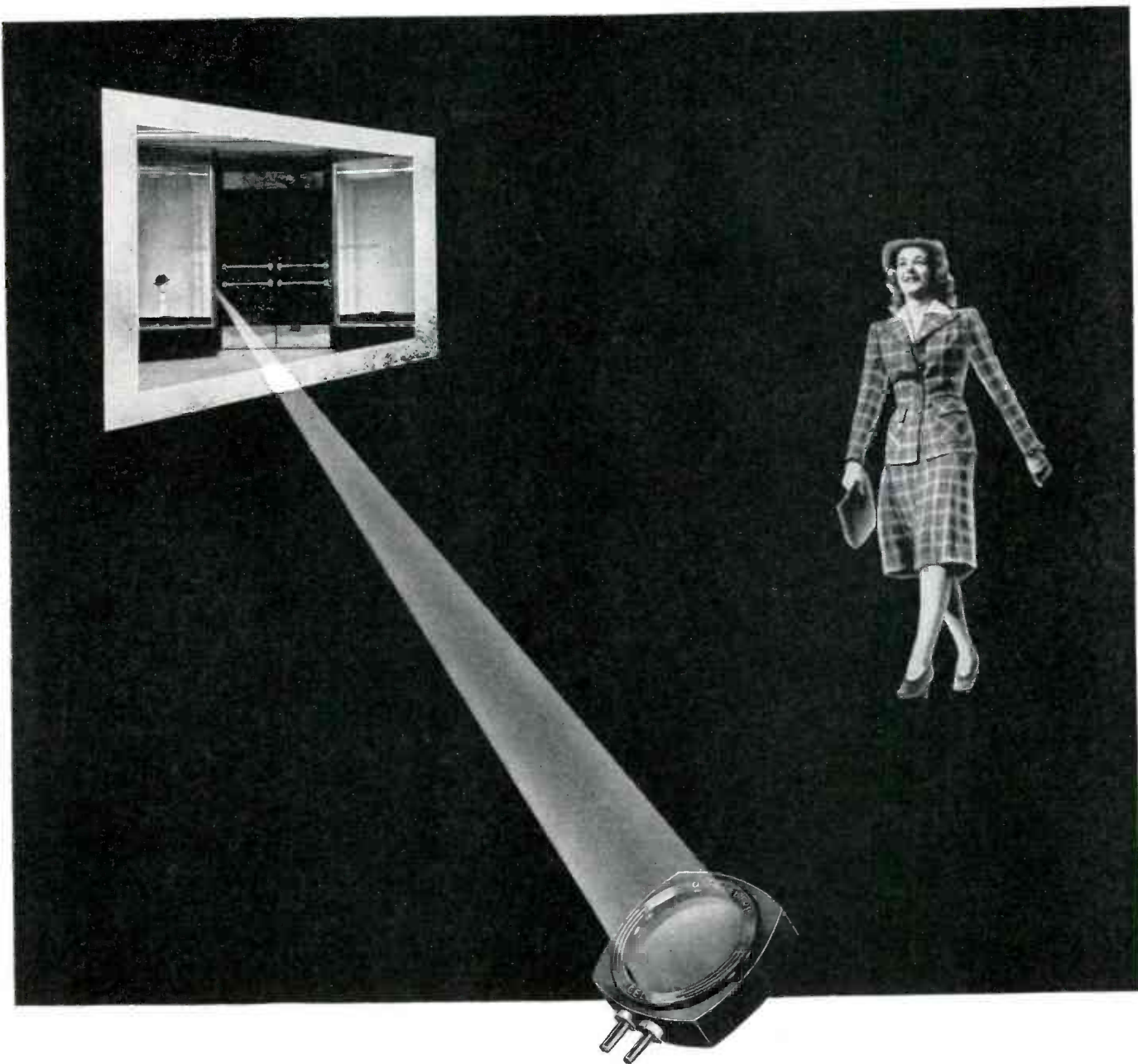

## How to beat a woman—TO A DOOR

One way to startle the lay public into awed pleasure is to show them a door opened by means of a photocell.

The practical beauty of this stunt is that you can do it over and over again without failure, even where shattering vibrations exist as part of normal operating conditions. For the Luxtron\* photocell is really rugged.

Another advantage is that Luxtron photocells convert light into electric

energy for the direct operation of meters and meter relays without amplification. They are lightweight, too. They are a good way to beat competition to a customer.

If you have any control problem that has defied solution with a simple, durable piece of apparatus, perhaps Bradley can throw some light on it—and make that light do the work for you. Write for literature and samples.

Another "Coprox" Rectifier



This center tap, full wave rectifier for high frequency current is one of a useful group of copper oxide rectifiers developed by Bradley. Illustrated "Coprox" bulletin mailed on request.

\*T. M. REG. U. S. PAT. OFF.

PHOTOCELLS—MASTERS OF LIGHT

# BRADLEY

MASTER OF PHOTOCELLS

BRADLEY LABORATORIES, INC., 82 MEADOW STREET, NEW HAVEN 10, CONNECTICUT



## Telephone Type Plugs

Signal Corps • Navy Specifications

PLUG NUMBER	NUMBER CONTACTS	TYPE SLEEVE	SEE NOTE
PL47	2	Long	
PL54	2	Short	1
PL55	2	Long	2
PL55K	2	Shoulder	
PL68	3	Long	3
PL124	2	Short	1
PL125	2	Long	2
PL155	2	Off Set	2
PL354	2	Short	1
PL540	2	Short	1
B-180207	2	(Lock-Nut)	2
CAU-49109	2	Long	2
CRL-49007A	3	Long	3
NAF-1136-1	2	Long	2
NAF-212938-1	3	Long	3
NAF-215285-2	2	Short	1

Note 1 — Interchangeable with others Note 1.  
 Note 2 — Interchangeable with others Note 2.  
 Note 3 — Interchangeable with others Note 3.

OTHER DESIGNS TO ORDER

Simple things—these humble plugs, but Remler found a way to make them better, faster. Production has been doubled while man hours were reduced fifty per cent. This precision efficiency has been made possible by ingenious machines designed by Remler engineers to combine several operations.

The facilities of this organization, backed by 27 years of experience in radio, electronics and plastics will soon be available to sub-contract the manufacture of your peace time parts and components in metal and plastics.

*Inquiries invited, write—*

REMLER COMPANY, LTD. • 2101 Bryant St. • San Francisco, 10, Calif.

# REMLER

SINCE 1918

*Announcing & Communication Equipment*

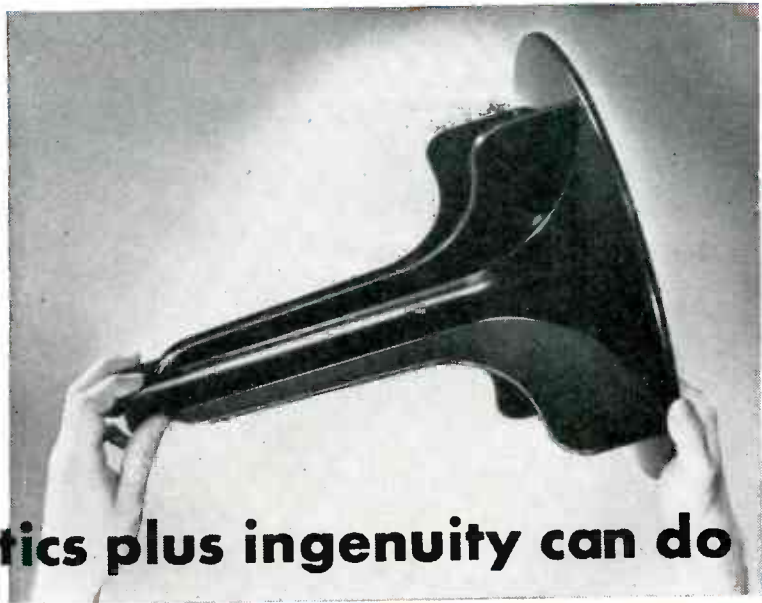

## Look what plastics plus ingenuity can do

Unsung hero of plastics progress is the custom molder. Through his untiring efforts and remarkable ingenuity, the use of plastics has become extensive in practically all fields of industry. Typical of the thousands of items which have been developed or improved through the intelligent application of plastics, is this Durez phenolic plastic washing machine agitator molded by Eclipse Moulded Products Co.

Reports from users of this molded Durez washing machine agitator attest a definite superiority over those made from other materials. The surface, for example, is permanently clean, smooth and lustrous from the moment it leaves the mold. Furthermore, it is inert to washing solutions and its action on clothes is easy and gentle. Tests which ran as long as 2400 hours continuously proved this agitator to be thoroughly satisfactory in every respect.

### Answering A Need

As long as twenty years ago, washing machine manufacturers were searching

for a plastic material that could be used in producing an agitator—the only part of the washer that remained the same year after year. The engineers turned to plastics—then in the adolescent stage—because they wanted an agitator that would increase the speed of the washing action while retaining a smooth, glossy surface that would be easy and gentle on clothes.

The Eclipse Moulded Products Company helped pioneer this search, and the molded Durez phenolic plastic agitator illustrated is the evidence of their persistence, ingenuity, and resultant success. Like so many of America's custom molders, they became aware of a need in industry and answered it completely.

### Versatile Plastic Used

Needless to say, the plastic used in molding this agitator had to be versatile, and the choice of the proper material was naturally most difficult.

A Durez phenolic plastic was selected for two reasons. First, the phenolics, in themselves, are the most versatile of plastics. Second, Durez has specialized in the production of the phenolics for over a quarter century and has a line of more than 300 molding compounds from which to select the plastic that precisely fits the job.

In this case, the emphasis was on moisture resistance, alkali resistance, excellent moldability, and impact strength. In another case, it might well be on dielectric strength, arc-resistance and non-bleeding. In all cases, the versatility of Durez phenolics is the natural starting point when you're struggling for the solution of a plastic material problem. The services of experienced Durez technicians, plus a wealth of proved product development data, are available at all times to you and your custom molder. Durez Plastics & Chemicals, Inc., 328 Walck Road, North Tonawanda, N. Y.

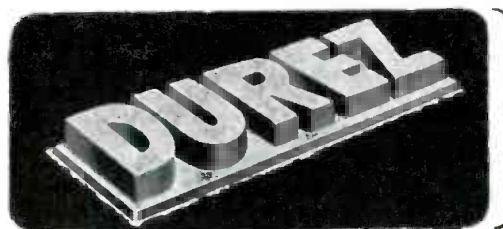

PHENOLIC  
RESINS

MOLDING COMPOUNDS

INDUSTRIAL RESINS

OIL SOLUBLE RESINS

## PLASTICS THAT FIT THE JOB

# Is this Memo for you?

## INTER-OFFICE MEMORANDUM

FROM: A.J.R.  
TO: Engineering Department  
SUBJECT: Rectifiers

Let's stop trying to solve our rectifier problems ourselves. After all, we're not specialists, and it seems to me that it's false economy.

I've just read that Green Electric Co. has over a million amperes of rectifiers now in use in leading companies. That sounds like some sort of record to me, and it also sounds as if Green is the outfit we ought to put on our particular job. Your comments will be appreciated.

A.J.R.



## Rectifier Experts...

Yes, Green has a darned good record in the rectifier field. And tough problems are our specialty. We survey your requirements and submit recommendations as to the type of equipment best suited to your needs, from every standpoint. Then, when you give us an okay, we build units to order—or make an adaptation of a standard model. We've got an A-1 rating on both metal-plate (low voltage) and tube (high voltage) jobs—on anything that calls for rectifier equipment.

MUNNING & MUNNING, INC.  
202 Emmet Street  
Newark 5, N. J.

BRUJAC ELECTRONIC CORP.  
11 Park Place  
New York 7, N. Y.

CROWN RHEOSTAT & SUPPLY CO.  
1910 Maypole Avenue  
Chicago 12, Ill.

A. J. LYNCH & CO.  
2424 Enterprise St.  
Los Angeles 21, Cal.

**"Rectifier Engineering is our Business"**



SELENIUM • ARGON • MERCURY VAPOR • GRID CONTROL • HIGH VACUUM • XENON

**W. GREEN ELECTRIC COMPANY, INC.**

SELECTRO-PLATERS AND ALL TYPES OF RECTIFIER EQUIPMENT

GREEN EXCHANGE BUILDING 130 CEDAR STREET NEW YORK 6, N. Y.

RECTIFIER  ENGINEERS

a beat frequency between 500 and 3000 cycles.

The Mecanitron unit illustrated is standard equipment; another model is available for relay-rack mounting with a tape puller.

Because the unit is constructed with a complete frequency shift receptor, no other equipment is required to secure complete mark and space information for Morse code or teletype use. When the recorder is used in conjunction with a Mecanitron scanner, complete teletype transmitting and receiving terminal equipment is achieved. Use of these two pieces of terminal equipment permits the transfer of printed matter at speeds exceeding 500 words per minute.

### Trigger Circuit

For use with standard teletype equipment, the Mecanitron recorder-amplifier comprises a special trigger circuit wherein a pulse is used to drive the moving pen. This allows use of a very low-impedance lightweight moving coil, permitting extreme speed.

The moving coil operates in the field of an Alnico-type permanent



The recording assembly of the high-speed code recorder. A low-impedance moving coil actuates the inking pen

magnet, insuring efficient temperature regulation regardless of climatic conditions. The moving assembly is pretreated to withstand any degree of moisture.

Bias and power controls are provided so that any degree of definition of message can be secured at any and all speeds. Morse code keying, up to 750 words a minute, can be received readily with the power control in the low position. From that rate, speeds up to 1250 words



**An improved product**  
*demands* **an improved wire!**

from .001 to .050 **SPECIFY SPENCER**  
 Beryllium, Phosphor Bronze and Stainless Steel wire for . . .

1. EXACT SIZES      2. SPECIAL USES      3. EXACT PHYSICAL CHARACTERISTICS

Manufacturers of today's and tomorrow's products can now demand — and get — controlled specification fine wire in Beryllium, Phosphor Bronze and

Stainless Steel. Spencer — originators of "Control Crimp" and "Spencerized" wire — invite your wire product problems.



**"SPECIFY SPENCER"**  
 for exact specifications



**SPENCER WIRE COMPANY**

WEST BROOKFIELD PLANT  
 WEST BROOKFIELD • MASS.

# "We heard voices over our shoulders!"



**A**s we built up the family of INCO Nickel Alloys, it was as though voices of future users were telling us which properties to incorporate.

Almost *everybody*, it seemed, wanted strength, toughness, and hardness, combined with corrosion resistance. (*And, with Nickel as the base, this was easy.*)

Then, individual voices were heard asking for *specialized* properties, in addition to these *group* properties.

Different users wanted: ... a metal with longer life at high heat... a corrosion-resistant metal, heat treatable to the strength and hardness of heat-treated steel ... a high-strength, non-magnetic metal ... a rustless, fatigue-resisting, spring metal ... and, *even*, the paradoxical combination of hardness and toughness with high-speed machinability.

Today, all — *and more* — of these demands are being met with the INCO Nickel Alloys.

When selecting metals for "tough" jobs, do you get *all* the properties you need? Or is your choice usually a compromise? There's less need for compromises with the INCO Nickel Alloys available. *Just refer to the 8 different "property-combinations" they offer!*

PROPERTY:	MONEL	"R" MONEL	"K" MONEL	"KR" MONEL	"S" MONEL	NICKEL	"Z" NICKEL	INCONEL
CORROSION RESISTANCE	HIGH	HIGH	HIGH	HIGH	HIGH	HIGH	HIGH	HIGH
STRENGTH	GOOD	GOOD	HIGH	HIGH	GOOD	GOOD	HIGH	GOOD
TOUGHNESS	GOOD	GOOD	HIGH	GOOD	GOOD	HIGH	HIGH	HIGH
HARDNESS	GOOD	GOOD	GOOD	GOOD	HIGH	FAIR	HIGH	GOOD
MACHINABILITY	GOOD	HIGH	GOOD	HIGH	GOOD	GOOD	GOOD	GOOD
NON-GALLING	NO	NO	NO	NO	HIGH	NO	NO	NO
SPRING PROPERTIES	GOOD	NO	HIGH	NO	NO	GOOD	HIGH	HIGH
ELEC. CONDUCTIVITY	POOR	POOR	POOR	POOR	POOR	GOOD	GOOD	POOR
HEAT RESISTANCE	GOOD	GOOD	GOOD	GOOD	HIGH	GOOD	GOOD	HIGH
HEAT TREATABLE	NO	NO	YES	YES	YES	NO	YES	NO
NON MAGNETIC	NO	NO	YES	YES	YES	NO	NO	YES

THE INTERNATIONAL NICKEL COMPANY, INC.  
67 Wall Street, New York 5, N. Y.

MORE INFORMATION? — Tell us the alloy that interests you, and we'll mail more information. Or, send for "List B-100" listing over 100 bulletins which explain the properties and applications of the INCO Nickel Alloys.

NICKEL  ALLOYS

MONEL • "K" MONEL • "S" MONEL • "R" MONEL • "KR" MONEL • INCONEL • "Z" NICKEL • NICKEL • Sheet... Strip... Rod... Tubing... Wire... Castings... Welding Rods (Gas & Electric).



**FOR ALL ELECTRICAL APPLICATIONS --**

**BH EXTRA FLEXIBLE FIBERGLAS SLEEVING**



**WON'T HARDEN, CRACK OR ROT!**

**SNUB TEST**

Proves BH Non-Fray Feature



Make this test yourself. Tap a piece of ordinary saturated sleeving on your desk top and see how easily it frays. Then do the same with BH Extra Flexible Fiberglas Sleeving. It only fuzzes a little—doesn't break down—doesn't fray.

**THE RESULT**



◀ The BH Way



The Ordinary Way ▶

**BH EXTRA FLEXIBLE FIBERGLAS SLEEVING**

**2 WAYS BETTER**

**NON-FRAYING • NON-STIFFENING**

**W**HY give a few cents worth of electrical insulation a chance to be the weak link in your product? Use BH Extra Flexible Fiberglas Sleeving—the one insulation with all these advantages:

It is permanently non-fraying, non-stiffening and non-burning, by virtue of the exclusive BH process. It will not dry out, crack or rot, retaining its original unusual resistance to high and low temperatures, moisture, oil, grease and chemicals indefinitely.

If you want an all-purpose sleeving that simplifies assembly and maintenance and gives longer maximum protection, standardize on BH Extra Flexible Fiberglas Sleeving. Available in all standard colors and sizes from 5/8" to No. 20, inclusive. Write for free samples today and compare by actual test!

**HOW TO KEEP CUSTOMERS COOL AT 1200°F!**

Direct contact with heat up to 1200°F does not harm BH Special Treated Fiberglas Sleeving, the non-burning, unsaturated, flexible-as-string sleeving that stays supple and won't fray when cut. Made in natural color only—all standard sizes. Get this extra protection now and keep customers' temper cool, too!

**ALL BH PRODUCTS AVAILABLE IN STANDARD 36" LENGTHS and 500-FT. COILS**



ALSO SLOW-BURNING IMPREGNATED MAGNETO TUBING • SLOW-BURNING FLEXIBLE VARNISHED TUBING • SATURATED SLEEVING • A.S.T.M. SPECIFICATIONS

**BENTLEY, HARRIS MANUFACTURING CO.**

**Dept. E Conshohocken, Penna.**



*Quality...*

## A Success Secret of CAPACITRONS

The Capacitron reputation for progressive design, superior craftsmanship and dependable service is backed by a continuous research program covering every capacitor manufacturing operation. No Capacitron production process is ever given a chance to become "standard procedure" — it is always an engineering project — always open for immediate improvement. Through this system of *method control* has come unquestioned leadership for Capacitron Oil, Wax and Electrolytic Capacitors . . . our customers call it Quality.



Telephone VAN Buren 3322

**The CAPACITRON Company**  
849 North Kedzie Ave., Chicago 51, Illinois

a minute are obtained with a pen-stroke of  $\frac{1}{8}$  in. with the power control at full-on position. The character height is adjusted by decreasing or increasing the pen-stroke.

The mechanical assembly allows the thumbscrew removal of the entire pen-arm assembly for quick interchange of parts, if necessary. A constant-flow type of ink-well is used.

One Mecanitron unit has been on test service for four months continuously, 24 hours a day, without interruption. No wear appears on the bearings or on any other moving part.

• • •

### Multi-Channel High-Speed Communications With Standard Radio Equipment

BY WAYNE M. ROSS

A MODERN MILITARY communications system is a very centralized affair, all communications originating from and arriving at a central communications office. The high-powered transmitting and receiving stations are usually located at a point remote from this central office. A usual method of interconnection is a multi-channel, d-c/audio tone, converter, combining a number of telegraph signals into a single land telephone line. These signals are then filtered, rectified and used to key the sending transmitter, or incoming, to operate the printing equipment at the central point. In this way an operator, at the central office, can operate, directly, by hand key or automatic sender any particular remote transmitter. Likewise, an incoming signal would be converted to a d-c telegraph signal at the receiver, operate the relay in the audio frequency telegraph unit, sending an audio tone of a particular frequency on to the line, a number of these signals of different audio frequencies being fed to one line. These operate the printer at the central office.

Under war conditions, these land lines, being subject to bombing, are not as dependable as might be desired. In Great Britain in 1942, vhf radio links were suggested and

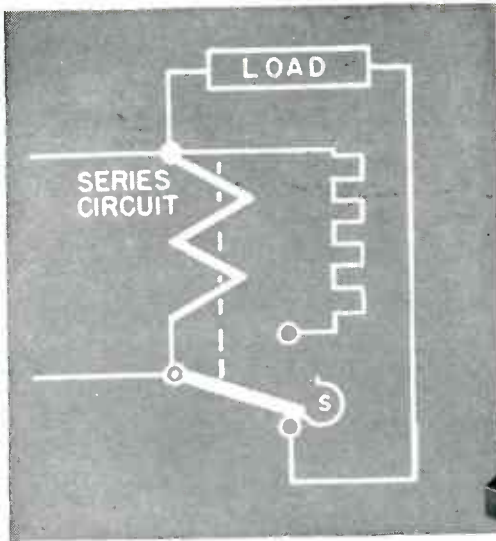

An extremely close differential application using a shunted coil circuit on the armature of a standard Struthers-Dunn Type 79XAX Snap-Action Relay.

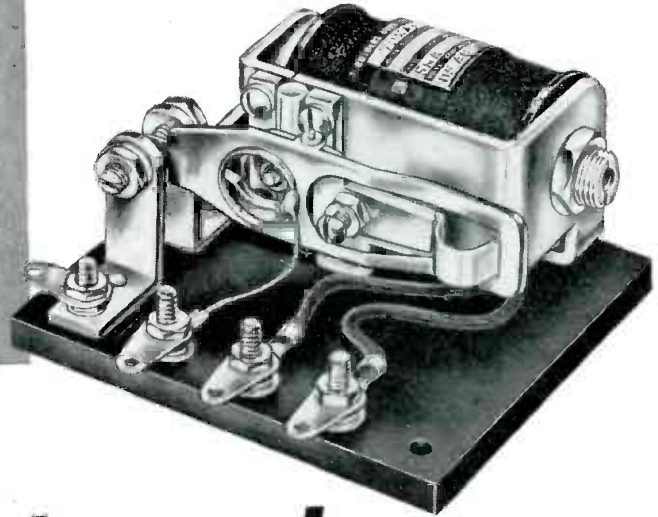

# Anything Less than EXACTLY THE RIGHT RELAY ..... is Poor Economy

5312  
Relay  
Types

Don't waste time and money engineering "around" a relay or timer that is not EXACTLY suited to your application. Nine times out of ten Struthers-Dunn can fit you out with *standard* units ideally suited to your uses in every respect. Actually there are 5,312 *standard* Struthers-Dunn types from which recommendations can be made. Each one is subject to almost infinite design adaptations. Going beyond this, Struthers-Dunn engineering experience is such that no concern is better fitted to design custom built relays to meet your specific conditions.

STRUTHERS-DUNN, INC., 1321 Arch St., Philadelphia 7, Pa.

# STRUTHERS-DUNN

*Relay and Timer Specialists Since 1923*

DISTRICT ENGINEERING OFFICES: ATLANTA • BALTIMORE • BOSTON • BUFFALO • CHICAGO • CINCINNATI • CLEVELAND  
DALLAS • DENVER • DETROIT • HARTFORD • INDIANAPOLIS • LOS ANGELES • MINNEAPOLIS • MONTREAL  
NEW YORK • PITTSBURGH • ST. LOUIS • SAN FRANCISCO • SEATTLE • SYRACUSE • TORONTO

# KEN-RAD

## CATHODE-RAY TUBES

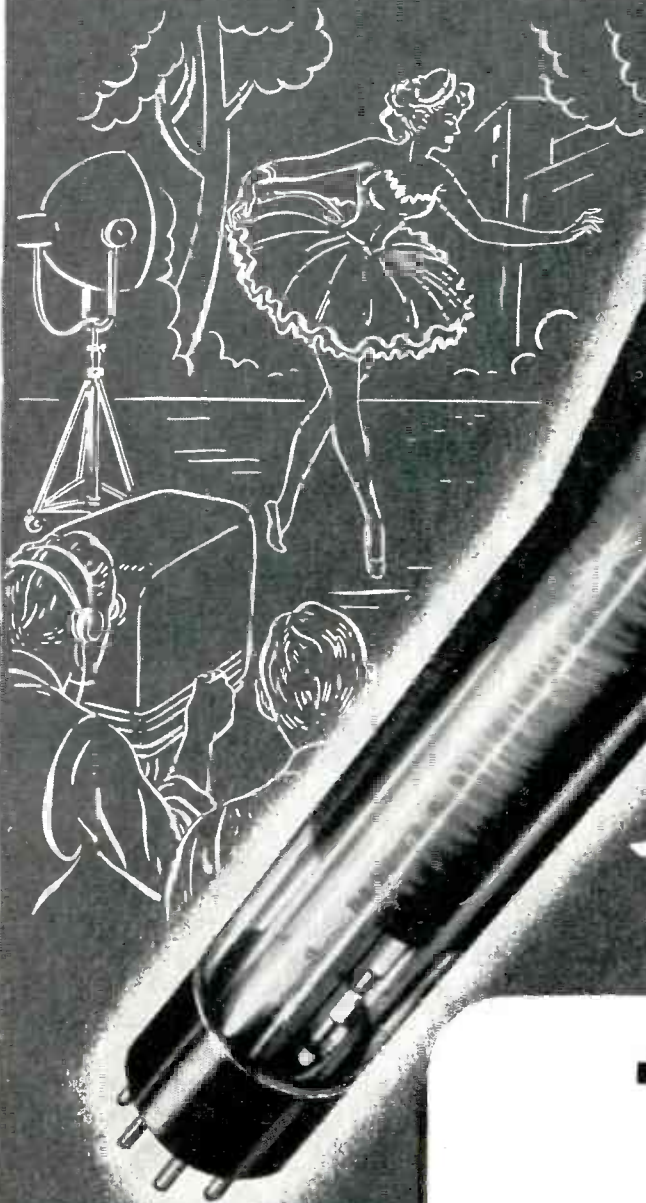

*Better  
than ever*

- ▶ Television, oscillograph, and other images are bright, clear, and sharp when projected by Ken-Rad Cathode Ray Tubes . . . Now new research, new engineering facilities assure further advancement in Ken-Rad quality and efficiency . . . benefiting equipment designers and builders by tube performance that is *better than ever*.

• Write for your copy of "Essential Characteristics" the most complete digest of tube information available.

170-C-4-8350

**KEN-RAD**  
OWENSBORO, KENTUCKY

for every climatic

and atmospheric condition

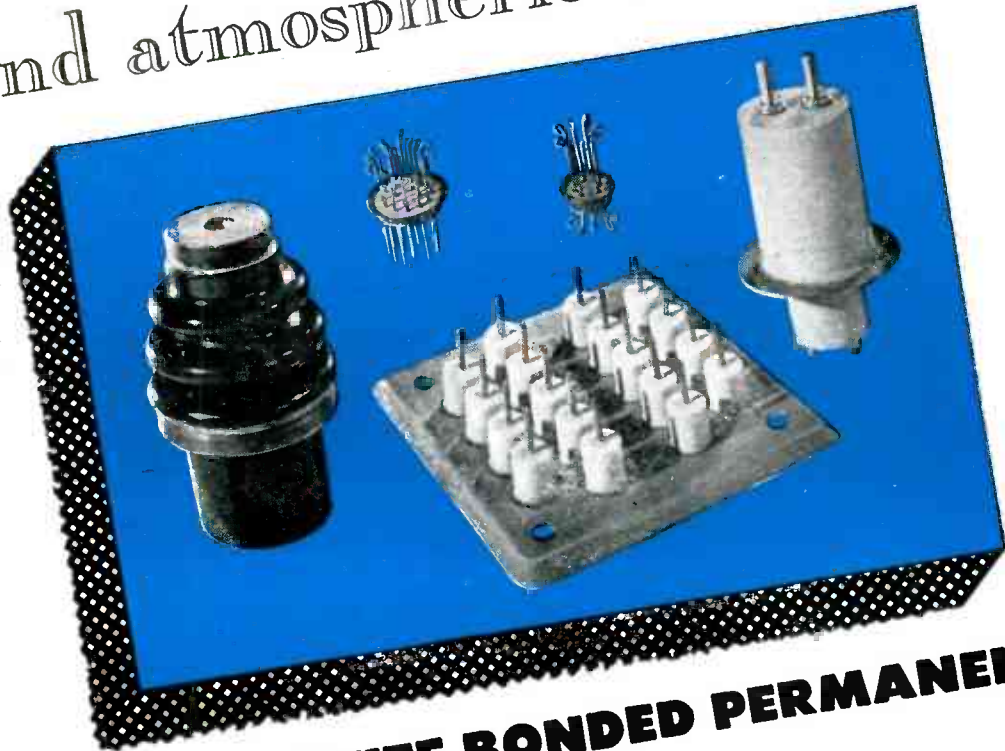

## STEEL AND STEATITE BONDED PERMANENTLY

- Sealex Bushings are designed to operate under all conditions of service, from hot and humid jungle atmospheres to sub-zero low pressure atmospheres encountered by airborne equipment at high altitudes. The steel and steatite components of these bushings are fused together under high temperature conditions forming a permanent hermetic seal impervious to humidity and pressure changes. The unit thus obtained has great mechanical strength. Each design has successfully passed severe temperature, vibration and handling tests to insure against mechanical failure. Each individual bushing is tested in our plant to withstand 50 lbs. p.s.i. air pressure before shipment. Sealex Bushings are available in single and multiple terminal designs for high and low voltage requirements. Complete specifications and details are available in the Sealex catalogue. Write for your copy today.

### SALES REPRESENTATIVES

J. J. PERLMUTH & ASSOCIATES  
942 Maple Avenue  
Los Angeles, Calif.

MICA COMPANY OF CANADA LTD.  
Hull, Quebec

HARRY W. GEBHARD  
737 No. Michigan Avenue  
Chicago, Illinois

PAUL R. STURGEON  
25 Huntington Avenue  
Boston, Mass.



**LARGE** . . . B&W heavy-duty rotary coils of this type are admirably suited for dielectric heating, as well as a wide variety of other uses.

**MEDIUM** . . . Ideal general purpose rotary coils. Current carrying capacity approximately 15 amps. In a wide range of inductance values

**SMALL** . . . This little coil has dual opposed windings and is continuously variable—a typical example of B&W construction applied to a special design.

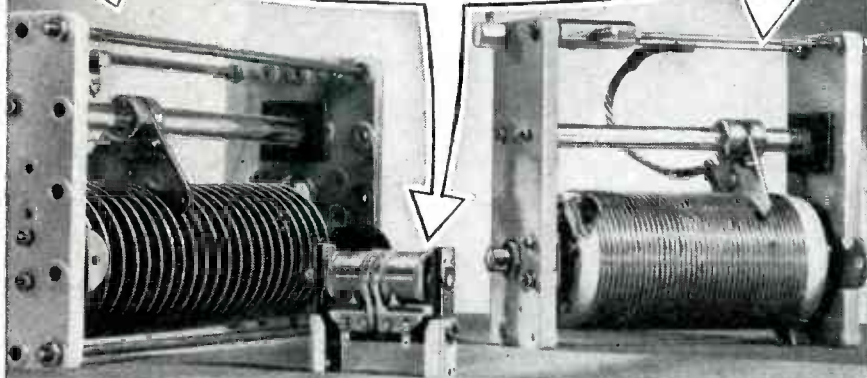

## GENERAL PURPOSE ROTARY COILS

*...in a wide range of inductances, voltages and capacities*

Typical of the completeness and engineering supremacy of the general line of B&W Air Inductors, these rotary coils are available in standard or special types, sizes, and shapes to meet practically any rotary coil requirement. Bring your coil problems to coil headquarters! B&W engineers will gladly make recommendations based on an unparalleled experience in this specialized, rapidly advancing field.



### BARKER & WILLIAMSON

AIR INDUCTORS • VARIABLE CONDENSERS • ELECTRONIC EQUIPMENT ASSEMBLIES

DEPT E-85, 235 FAIRFIELD AVENUE • UPPER DARBY, PA.

Export: LINDETEVES, INC., 10 Rockefeller Plaza, New York, N. Y., U. S. A.

tried for this service with good results, up to 70 miles, depending on the terrain.

#### Equipment

The only radio equipment of this kind available was designed for police use and operated in the 75 to 100 mc band. The transmitter was a 100-watt unit having a phono pickup input and was designed for good speech quality.

The receivers were of a conventional type and, like the transmitter, had been designed for high-fidelity speech. They incorporated a diode noise limiter in the detector circuit. They were fixed frequency, crystal controlled, using the 18th harmonic of the crystal frequency for oscillator injection.

In the first attempt to provide this service, the vhf link was set up over a distance of about 70 miles, passing over a range of hills, about 1,000 feet higher than the transmitting and receiving stations, using a four-element array sending and a three-element parasitic array receiving. Vertical and horizontal polarization were tried with the horizontal giving slightly less fading.

The send line from the voice-frequency telegraph was terminated in a 600-ohm resistance and fed into the phono input of the transmitter, the modulation level being adjusted to about 50 percent.

At the receiving end, as the receivers had a 2.5-ohm output for an external speaker, a 2.5-600-ohm transformer with a pad on the line side was used. The output was taken by a short line to the telegraph receiving equipment where the d-c signals were used to operate the conventional high-powered transmitters.

This system worked quite satisfactorily when keying speeds of 40-50 wpm were used, but gave considerable error on higher speeds. This was primarily due to a flutter fading in the receiver carrier. The line level at the receiver required adjustment two or three times per day. Considerable fading occurred about sunset with extremely strong signals after dark and fading again at daybreak.

The next installation was made in the tropics. Here there were two

★ *Star performance every time!*



## BALLENTINE RECORD CHANGER

*For*

Dependable, Trouble-Free Performance  
Advanced Features, Basic Improvements  
Found in No Other Changer

*Star Performance in Record Changers*  
means positive changing action, low rumble,  
no broken records, perfect adjustment in  
spite of careless or accidental handling,  
minimum "wow".

Such performance has been little more than  
an engineer's dream, until the Ballentine  
Changer made it a reality.

New major principles of design and operation  
were developed after thorough research disclosed  
the basic requirements of the simple,  
dependable, trouble-free changer.

Today the Ballentine Record Changer stands  
unexcelled in the field, the quality record  
changer for the radio manufacturer, assuring  
complete customer satisfaction. Available in  
different price ranges.

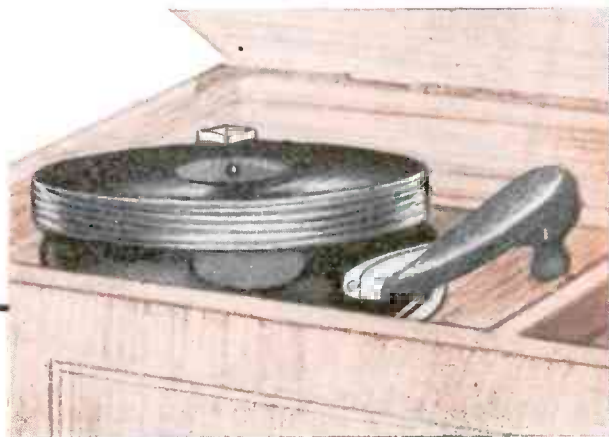

*The Ballentine Record Changer  
means  
Star Performance—every time*

**RUSSELL ELECTRIC COMPANY**  
364 W. HURON STREET, CHICAGO 10, ILLINOIS • *Manufacturers of*  
**BALLENTINE RECORD CHANGERS**

# Dulac FUNGUS RESISTANT LACQUERS, VARNISHES and COATINGS

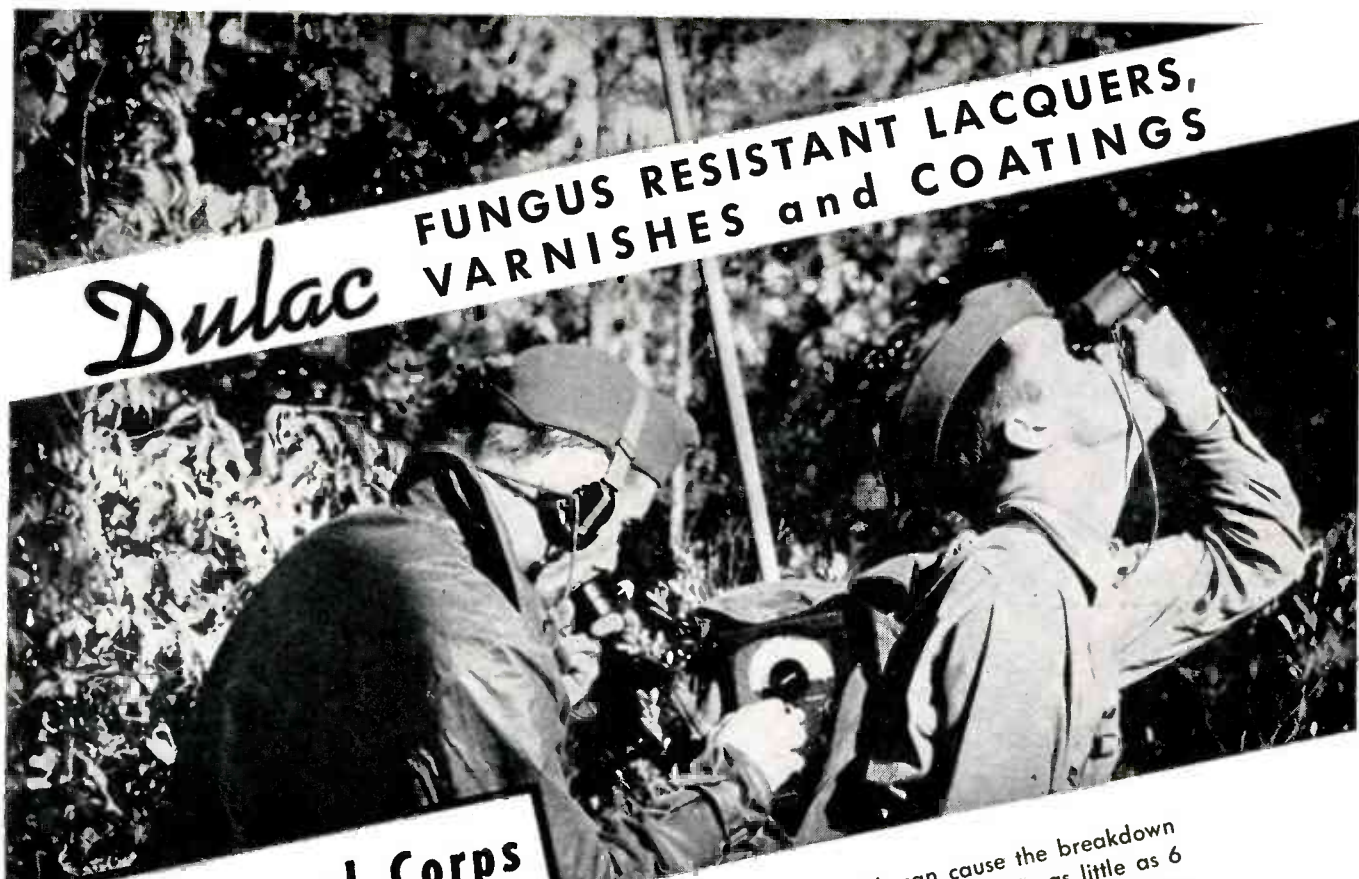

## MEET Signal Corps Spec. No. 71-2202-A

**DULAC FLUORESCENT SOLUTION #1A**  
Mixed with fungus resistant lacquers, varnishes and coatings, gives fluorescence under black light which facilitates inspection procedure. Use of a fluorescent solution is now required by Signal Corps.

**FUNGI SHIELD WAX BASE #100A**  
Concentrated fungicidal wax base for mixing with insulating waxes to render them fungicidal.

Tropical fungus growth can cause the breakdown of vital communication equipment in as little as 6 hours' time. To protect these lines of communication, all equipment sent to the tropics is being covered with a moisture and fungus resistant coating.

Built to Signal Corps and Navy specifications, M&W's Dulac coatings contain mercury bearing and non-mercury bearing fungicidal agents and are moisture resistant. They may be applied by brush, dip or spray for overall treatment. Resistant to fires, they also have excellent insulating properties which make them capable of withstanding sudden temperature changes.

**DURAD FUNGUS RESISTANT COATING #524**  
Contains mercury bearing Fungicide.

... for phenolic insulators, terminal blocks, junction blocks and the fixed windings of motors, generators and dynamotors. Bake ¾ hours @ 250° F.

**Protecting the Lifeline of Communications**

Send for Bulletin "Dulac Fungus Resistant Coatings for Tropicalization of Radio, Signal and Communication Equipment."

**MAAS & WALDSTEIN COMPANY, NEWARK, N. J.**  
PRODUCERS OF LACQUERS, ENAMELS, SYNTHETICS AND SPECIALTY FINISHES FOR ALL PURPOSES  
BRANCH OFFICES & WAREHOUSES: 1658 CARROLL AVE., CHICAGO, ILL. • 1228 W. PICO BLVD., LOS ANGELES, CALIF.

for a quick "Finish"  
Buy More War Bonds







## **PATHWAY TO EARTH... *Everywhere***

*All over the world...* from the mud-caked European fields to sun-baked airstrips in southern Burma . . . Federal Instrument Landing Systems are "bringing 'em in". . . *on the beam.*

Bombers, pursuit ships, night-fighters, transports . . . American, Canadian, British, Russian . . . ships wearing all the colors of the Allies . . . coming in on this "pathway

to earth", day and night, through the toughest kinds of flying weather.

This is the instrument landing equipment that Federal developed over more than ten years of intensive research . . . and which has set the standard for aerial navigation equipment in all parts of the world.

For the coming "age of the air" . . . see Federal first for the finest in aerial-navigation and communications equipment.



*Federal Telephone and Radio Corporation*



Newark 1, N. J.

THE COMCO LINE IS

*Customized*

Engineered for Long Years  
of Dependable Performance

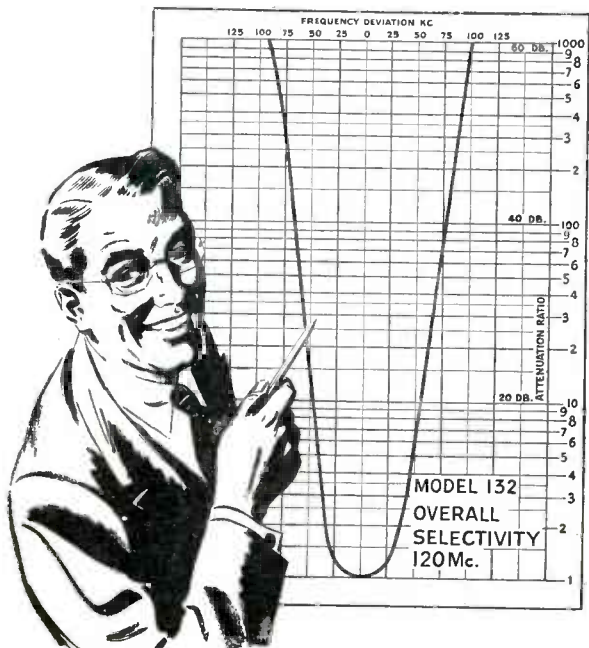

Painstakingly designed and built by seasoned engineers and skilled craftsmen in *limited* volume, COMCO Electronic Equipment, in every way, measures up to highest *custom* standards. Easy to service, COMCO guarantees you long years of dependable performance under all climatic and working conditions.

MILITARY COMMUNICATIONS (continued)

base establishments, each having high-powered sending and receiving stations. These establishments were separated by approximately 180 miles of jungle and a 4,000-10,000-foot mountain range. The time required for installation, and the difficulty of maintaining a land telephone line, made the vhf system a very desirable project. It was decided to use an 18-channel voice-frequency telegraph system, both sending and receiving, between the two establishments. The 18 send and 18 receive channels were terminated at a small exchange at each end. These channels were to be used for teleprinter service between the two points or control of any transmitting or receiving equipment from the communications office at either end.

*Radio Link*

The first step was the establishment of the vhf radio link. This was accomplished by setting up transmitters on different frequencies, at each end of the 180-mile link. A mobile repeating unit using a Hallicrafters SX27 receiver, 30-watt portable transmitter and accessory equipment complete with crew set out to explore and test for signal strength all the accessible points near the top of the mountain range.

A site was finally chosen, at an altitude of 4,000 feet in the midst of a tea plantation. The only obstruction to the visual line of sight was a projection of the range a few hundred feet higher than the site chosen and perhaps 20 miles away.

Strength of the signals was extremely good. After a semi-permanent installation using 100-watt transmitters had been made, the carrier was measured and found to be from 50 to 100 microvolts (at the receiver) on all links. This carrier strength was sufficient to operate the receivers with a good ave voltage.

An audio tone was fed over the entire link, originating at one end, then the repeater station linked back, and the signal measured at the originating point. The maximum variation over 24 hours, except for short periods of fluctuation, caused by variation of the portable power units, was 5 db. The wire

**COMCO TRANSMITTER Model 170**

Reliable VHF, 50 watts output. Frequency range 100 to 165 Mc. Cabinet size: Width 23"; depth 18"; height 48"; COMCO Model 127AA Transmitter also available for operation on a frequency range of 200 to 550 kc.



**COMCO RECEIVER Model 132**

Compact VHF crystal controlled, fixed frequency, superheterodyne. Single channel reception; 5 1/4-inch relay rack panel mounting. 12 tubes. Frequency range 100 to 165 Mc. Medium and low frequency receivers also available.



WRITE! Just a note on your company letterhead outlining your exact requirements. We'll give you the benefit of our specialized experience. We can supply a wide variety of customized equipment on priority NOW. We are accepting non-priority orders for post-war delivery.

MANUFACTURERS OF RADIO & ELECTRONIC EQUIPMENT



COMMUNICATIONS COMPANY, Inc.

CORAL GABLES 34, FLORIDA

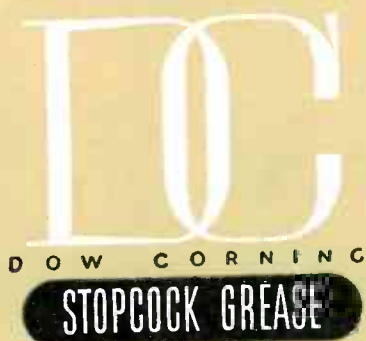

# High Vacuum Type

the special silicone lubricant  
designed for  
high vacuum applications

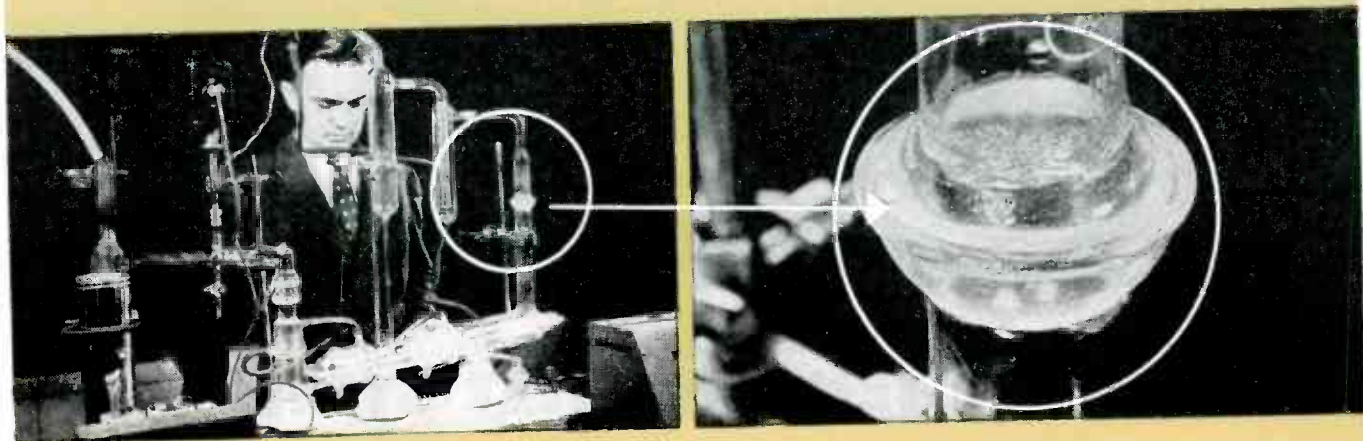

New Dow Corning Stopcock Grease, High Vacuum Type, satisfies customer demands for a silicone lubricant which effectively seals and still prevents freezing of stopcocks and other ground glass joints under high vacuum. ¶ This heavier, highly specialized grease is further characterized by the heat stability, low vapor pressure and chemical resistance associated with silicone lubricants. ¶ Because of its exceptional film strength ¶ Stopcock Grease, High Vacuum Type, maintains adequate film thickness to provide easy operation of stopcocks and to facilitate disassembly of ground glass joints in high vacuum equipment.

Laboratory supply houses in the United States and Canada stock both ¶ Stopcock Grease, High Vacuum Type, and ¶ Stopcock Grease.

**DOW CORNING CORPORATION**  
MIDLAND, MICHIGAN

*Dow Corning*

FIRST IN SILICONES

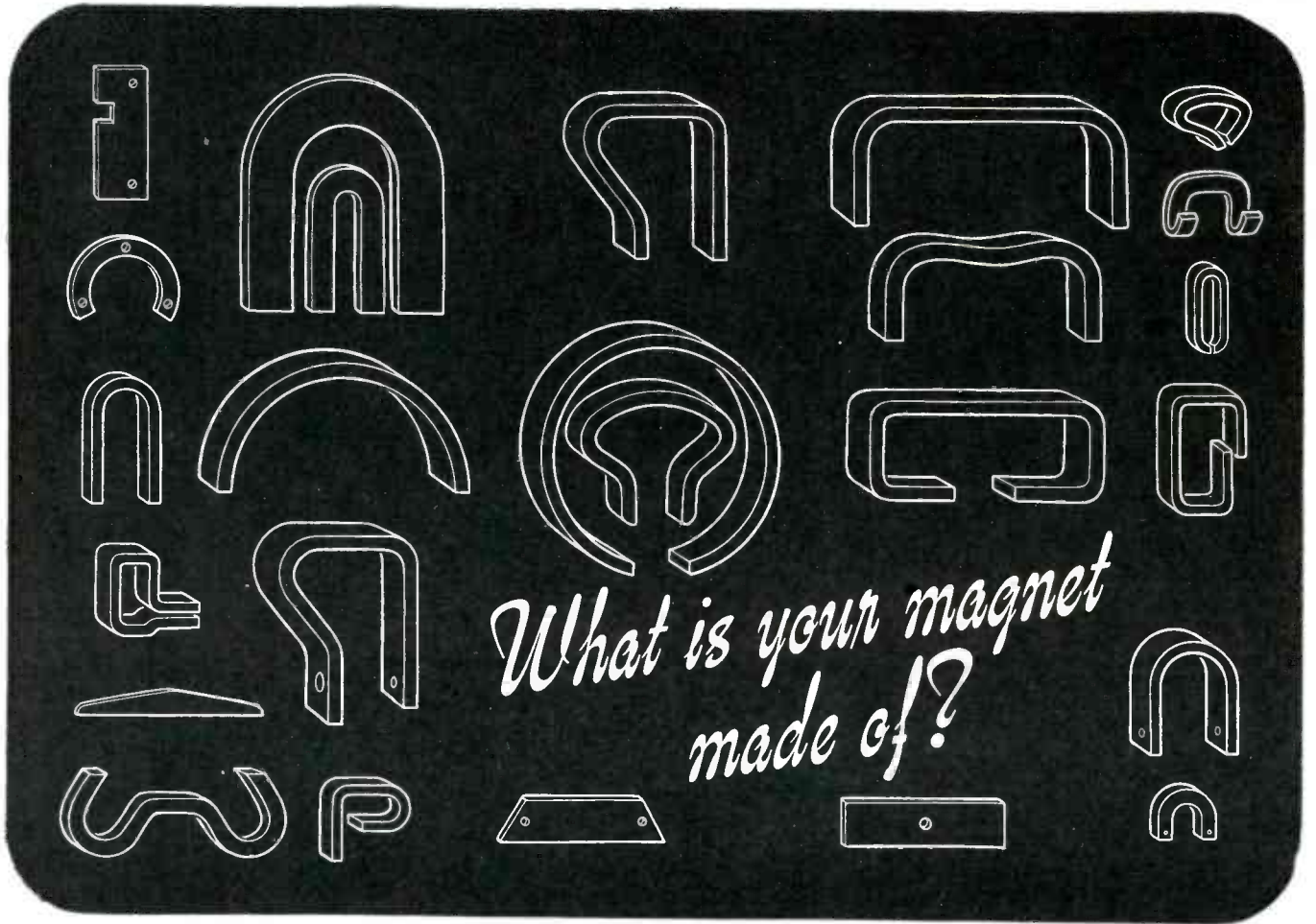

*What is your magnet made of?*

(This is the first of three advertisements regarding permanent magnet materials)

## PERMANENT MAGNET STEELS

Natural successors to primitive soft iron magnets were those of carbon steel to which, later, were added chromium, tungsten or cobalt. They may be formed from rolled stock, or cast in desired shapes, and can be drilled and machined after an annealing operation. They are heated to precise temperatures and then quenched in oil or water to develop permanent magnet properties.

Materials in this group have high residual inductions and coercive forces ranging from 60 oersteds in the chromium steels to 250 oersteds in the high cobalt grades. Because these materials are machinable, they may be used to advantage in some applications requiring machining and having magnetic requirements within their limitations. Proper allowance

must be made for the demagnetizing effect of stray magnetic fields and vibration, and care must be taken that their temperature limits are not exceeded.

The Indiana Steel Products Company uses numerous magnet steels and Alnico alloys in both cast and formed magnets, and has the specialized experience to select the material best suited to each specific job, engineering personnel to create the optimum design, and equipment to furnish the permanent magnets most suitable for any application. The complex factors of magnet design make engineering consultation advisable; many problems call for development or research. Write for complete information. Send for free copy of technical hand book: "Permanent Magnet Manual."

★ ★ ★ **THE INDIANA STEEL**

6 NORTH MICHIGAN AVENUE, CHICAGO 2, ILLINOIS



**PRODUCTS COMPANY** ★ ★ ★

Copyright 1946, The Indiana Steel Products Co.  
SPECIALISTS IN PERMANENT MAGNETS SINCE 1910



# PLASTICS . . . and . . . POWER

*for your coming products*

● We'd like to reidentify ourselves as the producers of two products not ordinarily associated in manufacture, but often in use. We refer to our molded plastics . . . and our low-torque, *Smooth Power* motors and small electric assemblies.

Our plastic molding ability is well known to many leading manufacturers. Their repeat purchases show their satisfaction at the alertness of our engineers, the ingenuity of our mold makers and the skill of our machine operators. You'll find General Industries' molded plastic parts in homes, offices and industry . . . on your transportation systems . . . yes, they help make the clothes you wear and the foods you eat.

Our *Smooth Power* electric drive mechanisms are built into many phonographs, recorders and combination record-changer-recorders which you play in your home or to whose music you listen on your radios. Their smoothness, quietness and dependability spring from long years of fine designing and accurate building, and fit them for domestic, commercial or industrial products where such characteristics are essential.

At present, our production is 100% military or priority. But, the time is not too far distant, we hope, when we can discuss peacetime business. When that day comes, we'd like to work with you on your needs for *molded plastics* . . . and small *motors*.

**THE GENERAL INDUSTRIES COMPANY**  
ELYRIA . . . OHIO

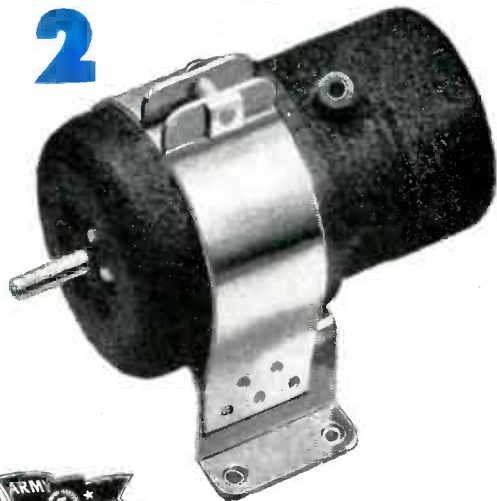

THE  
**GI** GENERAL INDUSTRIES COMPANY  
**MOTORS PLASTICS**

level, except for premonsoon atmospherics, was approximately -50 db.

*Cross Modulation*

The 18-channel voice-frequency telegraph equipment had an automatic gain control and would accept a variation of  $\pm 7$  db. It would also operate satisfactorily with a -30 db wire level. The only difficulty encountered was cross modulation between channels. Tests were conducted and the best modulation level for this equipment was found to be about 30 percent. This value was a compromise between wire level distortion and cross-modulation distortion experienced on higher modulation levels. With the additional precautions of careful balancing of interconnecting lines, suitable signal level on these lines (zero db telephone level) and use of carefully balanced modulator tubes, the cross modulation was reduced to a very low value.

This system would operate at signal speeds of 140 wpm on all 18 channels with very few errors. Also available was a standby link which could be used in case of failure of the regular equipment. This link had arrangement for connecting to the telephone exchange of the two headquarters establishments and was used for part-time radio telephone service between them.

• • •  
**TONE CHANGER**



With this machine, a physician can test a hard of hearing patient and determine the tone range that needs help. Called an otometer by Acousticon Research Laboratories, it changes the sound of each word into the limited tones heard by partially deafened ears



# STILL LEADING THE FIELD

Our Blue Ribbon Resistors were unique in their entirely new design and their advanced engineering when we introduced them in 1939.

They still lead the field as the most efficient:—their compactness, their toughness, and their remarkable performance offer you more than just higher wattage ratings for unit space required.

—And in our other types of resistors and rheostats we also offer you important exclusive advantages.

**HARDWICK, HINDLE, INC.**  
RHEOSTATS and RESISTORS  
DIVISION OF  
**THE NATIONAL LOCK WASHER CO.**  
ESTABLISHED 1886  
Newark 5, N. J., U. S. A.

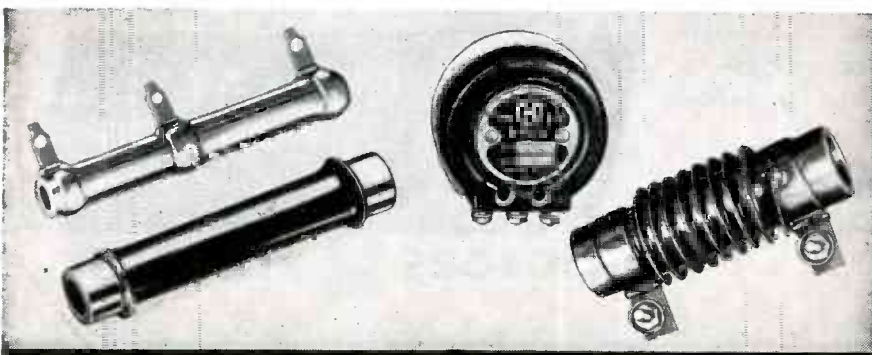

# Techrad dials for your

## post-war panels

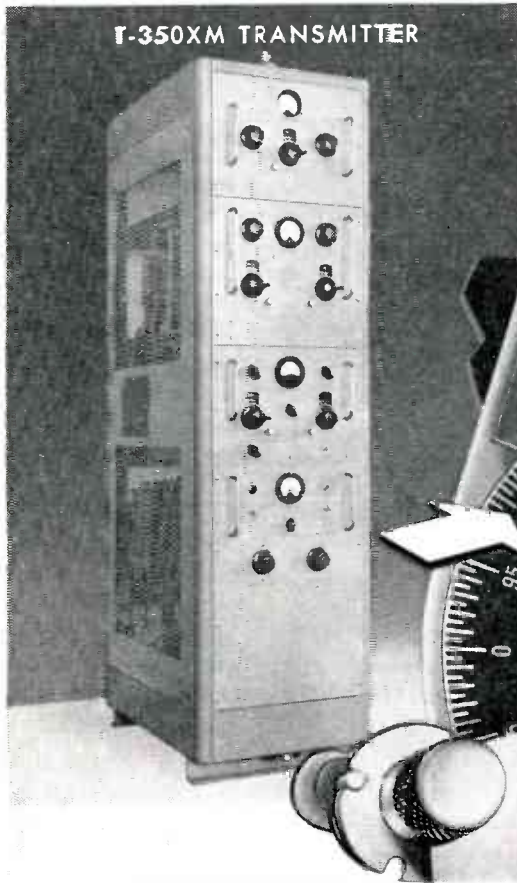

The "Counterdial," combining horizontal, drum-type counter with a flat interpolating scale, makes each revolution readable to 200 parts. The substantial phenolic crank-handle knob has molded-in insert to engage slot on dial driving shaft. The non-scrape positive acting dial lock completes this trio.

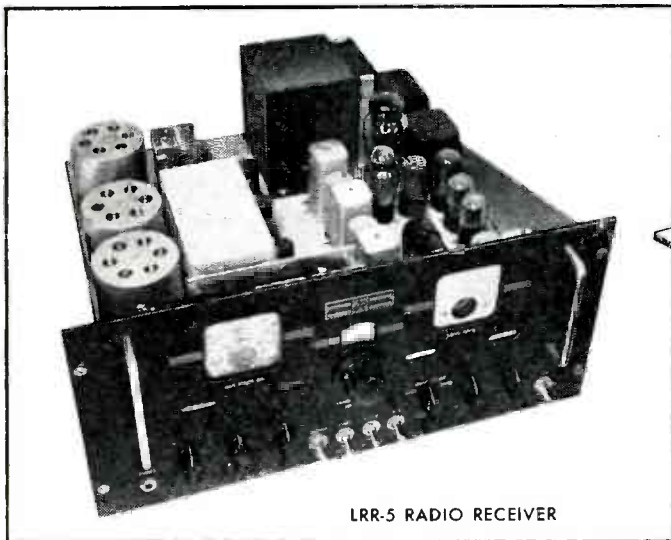

LRR-5 RADIO RECEIVER

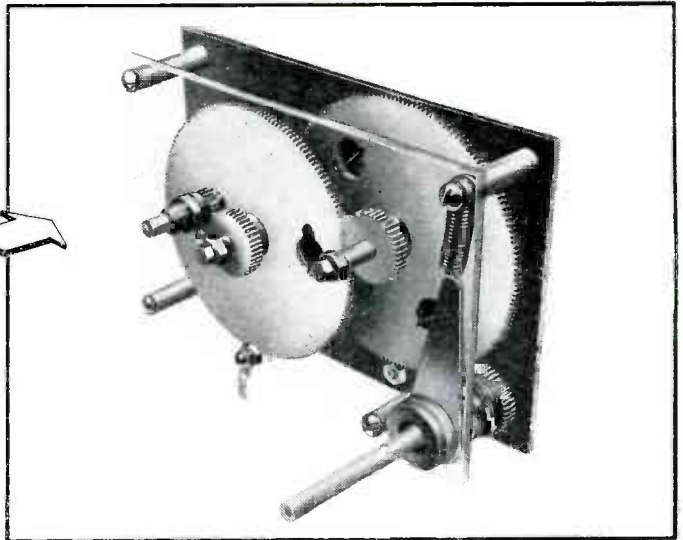

New additions to the TECHRAD dial group include two gear reduction drives. Ball race bearings, spring loaded for anti-backlash. Dial scale hub rotates 360° for 180° rotation of main driving hub . . . positive stop mechanism . . . 16 to 1 or 27.5 to 1 reductions.

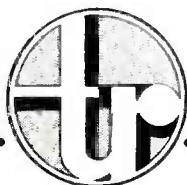

**technical radio company**

275 NINTH STREET • SAN FRANCISCO 3, CALIFORNIA

EXPORT AGENTS: FRAZAR & HANSEN, 301 CLAY STREET, SAN FRANCISCO 11, CALIFORNIA, U. S. A.

Over a decade of continuous experience

# THE ELECTRON ART

Television Receiver Symposium.....	252
Anti-Fade Antenna System.....	272
Electron-microphotography of Atoms.....	276
Three-phase Power From Single-phase Source.....	284

## Television Receiver Symposium

A PANEL DISCUSSION by television engineers on television receivers that reviewed the status of viewing systems was conducted by the New York section of the IRE at the section's June meeting. The following resume of the technical portion of the meeting combines the material that was presented both during the formal part of the meeting and during the following discussion period into topical groups forming a brief but broad review of the subject as it stands to date.

The speakers were George P. Adair, FCC, who spoke on frequency allocations; I. G. Maloff, RCA Victor Division, RCA, who

demonstrated reflective optics; Konstantin Pestrecov, Bausch & Lomb Optical Co., who analyzed refractive optics; Allen B. DuMont, Allen B. DuMont Lab., Inc., who reviewed direct image viewing; Dorman D. Israel, Emerson Radio & Phonograph Corp., who correlated the merits of direct and projection viewing; and P. C. Goldmark, CBS, who discussed color television.

### Television Frequencies

There is little possibility of additional television channels being provided below 300 mc. Below 225 mc, channels will be shared with other services. The 480-920 mc

band is now available for television research. The commission is now studying the geographic and transmission problems of channel sharing and the propagation study is to be extended in scope and frequency with the cooperation of industry.

Television stations require a wide channel and, because full use must be made of the radio spectrum and because television and f-m must gain public acceptance on the basis of their particular type of service, the commission will not permit stations to operate their sound channels while their video channels are dark. To retain its license, a television station must remain on the air a reasonable proportion of the time.

There are now six operating commercial television stations, three construction permits for commercial stations, 117 applications for commercial station permits, and applications for 11 experimental and nine relay stations. (For further details on FCC allocations, see *ELECTRONICS*, p. 92, July 1945.)

### Reflective Optics

Criticism of current television receivers is that the image is too small and too dim. By using reflective optics, an efficient optical system capable of considerable light gathering and magnifying power and little distortion can be economically built. A readily produced spherical mirror, whose only drawback is uniformly distributed spherical aberration, and a molded plastic corrective lens whose function is to provide an equal and opposite spherical aberration for correction of the mirror as illustrated in Fig. 1, plus a flat translucent screen constitute the projection system. The corrective lens is so weak that it does not introduce other aberrations. (Production and application are described in *Reflective Optics in Projection Television*, *ELECTRONICS*, p. 98, December 1944.)

Cathode-ray tubes used for projection-viewing television receivers operate up to 30 kv. At the higher voltages, the tube produces x-rays which, although they are weak, should be stopped from radiating into the room where their presence over a long time might prove harm-

## PRODUCTION LINE FOR HIGH-FREQUENCY HEATING



These Megatherm units are built for controlled surface and spot heat treatment in the metal industry and have been used for dielectric heating in the plastics, textile, food and woodworking industries. The assembly-line technique is employed in the plant of the Industrial Electronics Products Division of Federal Tel & Radio Corp.



# Why **OHMITE** Rheostats GIVE SMOOTHER, CLOSER CONTROL

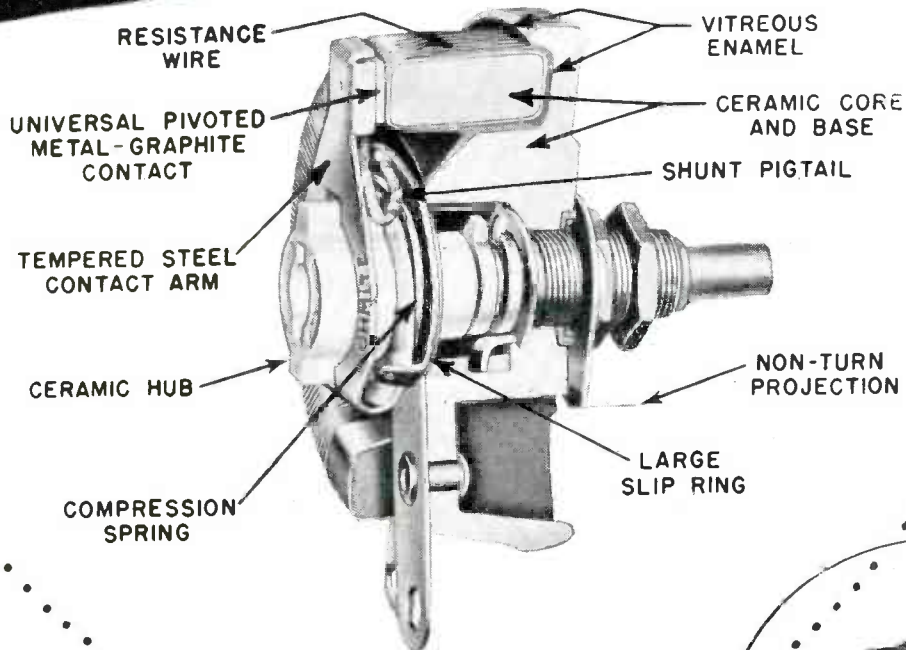

**DESIGNED AND BUILT TO WITHSTAND  
SHOCK • VIBRATION • HEAT • COLD • HUMIDITY**

In critical applications, engineers know they can rely on Ohmite design. Construction is compact . . . all ceramic and metal. The wire is wound on a solid ceramic core, locked in place and insulated by special Ohmite vitreous enamel. Each turn of wire is a separate resistance step. Self-lubricating metal-graphite contact brush rides on a large, flat surface . . . insures perfect contact, prevents wear on the wire. Tempered steel contact arm assures uniform pressure at all times. High strength ceramic hub insulates shaft and bushing. These are just some of the Ohmite rheostat features that provide permanently smoother, closer control.

**OHMITE MANUFACTURING COMPANY**  
4817 Flournoy Street • Chicago 44, U. S. A.

Ohmite Rheostats are extensively used in all types of applications . . . military and industrial. Widest range of types and sizes, in stock and special units, for every need . . . 10 models ranging from 25 to 1000 watts, from 1-9/16" to 12" diameter. Ohmite engineers are glad to assist you.

*Write on company letterhead for helpful Catalog and Engineering Manual No. 40.*

BUY MORE  
WAR BONDS

Be Right with **OHMITE**

RHEOSTATS • RESISTORS • TAP SWITCHES



# WILCO TUNGSTEN Contacts

To manufacturers of medium or high speed make-and-break mechanisms, Tungsten offers the highest melting point of any contact metal, plus high density, low vapor pressure at elevated temperatures, good hardness, strength, resistance to oxidation, and arc-resisting properties. The superfine quality of WILCO Tungsten Contacts assures maximum longevity in service. Other Wilco Powder Metal Contacts include Tungsten Alloys, also Silver Molybdenum, Silver Tungsten, Silver Cadmium Oxide and Silver Tungsten Carbide.

**CONSULT OUR ENGINEERING DEPARTMENT**—The precision performance of WILCO Electrical Contacts in planes, ships, tanks and instruments presage their widespread usefulness for postwar manufacturing customers. A representative of the WILCO Sales and Engineering Department will gladly help develop the proper application of WILCO materials to your products.

**SEND FOR WILCO BLUE BOOK**—Send for FREE copy of the WILCO Blue Book. It contains charts, formulae, and full descriptions of WILCO Electrical Contacts, and other WILCO products.

#### WILCO PRODUCTS INCLUDE:

##### CONTACTS—

Silver  
Platinum  
Tungsten  
Alloys  
Sintered Powder Metal

##### THERMOSTATIC BIMETAL—

High and Low Temperature  
with new high temperature  
deflection rates

##### PRECIOUS METAL COLLECTOR RINGS—

For rotating controls

##### SILVER CLAD STEEL

**JACKETED WIRE—**  
Silver on Steel, Copper,  
Invar or other combinations  
requested

##### ROLLED GOLD PLATE

**SPECIAL MATERIALS**

## THE H. A. WILSON COMPANY



105 Chestnut Street, Newark 5, N. J.

Branch Offices: Chicago • Detroit • Los Angeles

SPECIALISTS FOR 30 YEARS IN THE MANUFACTURE OF THERMOMETALS • ELECTRICAL CONTACTS • PRECIOUS METAL BIMETALLIC PRODUCTS

Belden CONNECT-A-CORD

Make Cord  
Replacements  
for a  
Vacuum Cleaner  
as easy as  
for an iron



and SAVE YOUR DEALERS  
COSTLY SERVICE CALLS

with the **Belden** *CONNECT-A-CORD*

what is the Belden  
CONNECT-A-CORD?

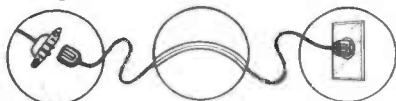

CONNECTOR + CONDUCTOR + PLUG

Users want this new advantage—

It's a new idea—still, as a result of a recent survey, over 33% of vacuum cleaner users were already found to be in favor of the advantages of the Belden Connect-A-cord.

This new Belden product is no "postwar dream." It is already engineered—and only offered after a thorough check which has shown conclusively that your customers want the Belden Connect-A-cord on their better electrical equipment.

There is something new in electrical cords! Belden Connect-A-cord eliminates costly service calls to repair cords and plugs. Makes replacement as easy and profitable for your dealers as iron cord replacement. The Belden Connect-A-cord

- 1 Provides a cord for every tool or appliance—detachable at the appliance end as well as the plug end.
- 2 Is available in various lengths and colors to fit any installation.
- 3 Simplifies line assembly operation. Simplifies packing and display.
- 4 Provides a NEW SALES FEATURE.

A worth-while sales feature—promoted by consistent national advertising. Get information on the new Corditis-free Connect-A-cord today.

Belden Manufacturing Company  
4625 W. Van Buren Street, Chicago 44, Ill.

**Belden**

*Corditis-free*

**CORDS**



Chicago, Ill.



Richmond, Ind.

# Specialists in Special Crystals

## SUPERSONIC CRYSTALS

Curved . . . spherical . . . or flat supersonic crystals for a full range of biological, chemical and materials testing purposes. Crystalab is specialist in them all. That's why leading manufacturers like Sperry Products Inc., whose renowned Reflectoscope employs our supersonic crystals, come to us with their problems.

If you have a problem or product involving the use of supersonic crystals, our engineers will be glad to have you consult them.

Write Dept. E.L. for comprehensive catalogue "Selectronic Crystals" and facilities booklet "Crystalab Solves a Problem".

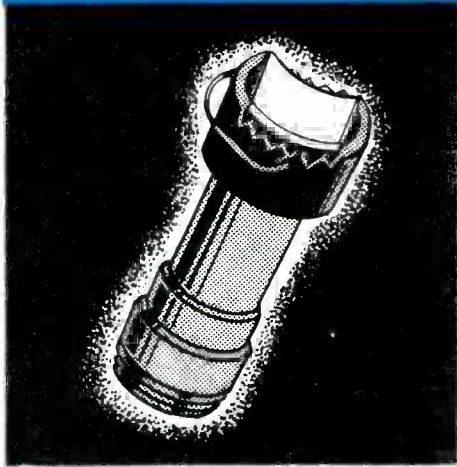

"Searching Unit" for Sperry Products' Reflectoscope



Yankee Ingenuity makes us

SPECIALISTS IN SPECIAL CRYSTALS



**CRYSTAL RESEARCH LABORATORIES INC.**  
HARTFORD, CONNECTICUT

ful to people; a thin metal sheet provides adequate shielding. The optical system should be in a dust-proof housing to prevent loss of efficiency from dirt fogging the mirror and lens surfaces.

### Refractive Optics

Because the cathode-ray tube provides so little light, the optical system must collect as much of that light as possible. This requirement necessitates a lens that will cover a large angular field, that is a lens of low  $f$  ( $f$  number of a lens is the ratio of its focal length to its diameter). It is feasible to produce lenses having an  $f$  of as low as unity (the smaller the  $f$ , the greater the light gather-

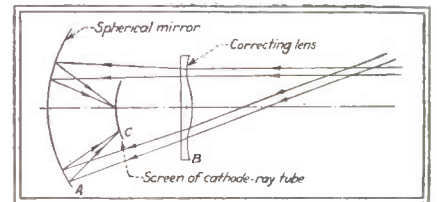

Fig. 1—Optical system of the Schmidt astronomical camera adapted by RCA for projection television

ing power of the lens), but because of production problems it is doubtful whether lenses of smaller  $f$  can be widely used. At present, television produces six ft candles on the viewing screen as compared to 15 ft candles on motion picture screens.

Large aperture lenses can be made that have, for example, a resolving power varying from 900 lines at the edge of the image to 3000 lines at the center at  $f/1.5$ . Thus the definition of the cathode-ray tube image is the limiting factor in such projection systems.

The translucent phosphorescent cathode-ray tube screen is inefficient in transmitting to its front surface the light generated by the electron stream on its back surface. This loss of light suggests the advisability of gathering the light from the back side of the tube screen. Rauland in Chicago and Baird in England have made tubes that do this; but because the electron beam must scan the screen at an oblique angle, and because the optical system must gather

## OPTICAL MIRRORS and REFLECTORS

FOR ELECTRONIC, OPTICAL AND SCIENTIFIC APPARATUS

WE specialize in the production of front or rear surface mirrors, made to your specifications. Closest optical and dimensional tolerances observed.

Because of their proven superiority, ZENITH mirrors are preferred by many leading manufacturers of precision equipment.

- EXCEPTIONAL REFLECTIVITY
- ALUMINUM, SILVER, GOLD, etc.
- OPAQUE OR SEMI-TRANSPARENT
- PERMANENT CHARACTERISTICS
- PROMPT SERVICE

We invite your inquiry. Samples and quotations will be submitted promptly.

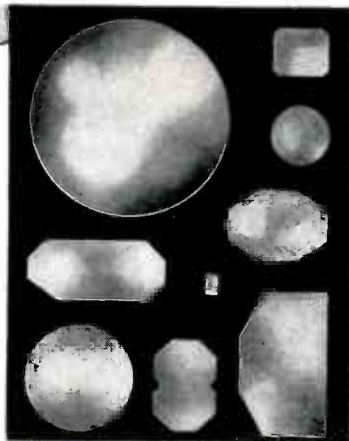

# ZENITH OPTICAL LABORATORY

SPECIALISTS IN VACUUM DEPOSITION



123 WEST 64th STREET  
NEW YORK 23, N. Y.

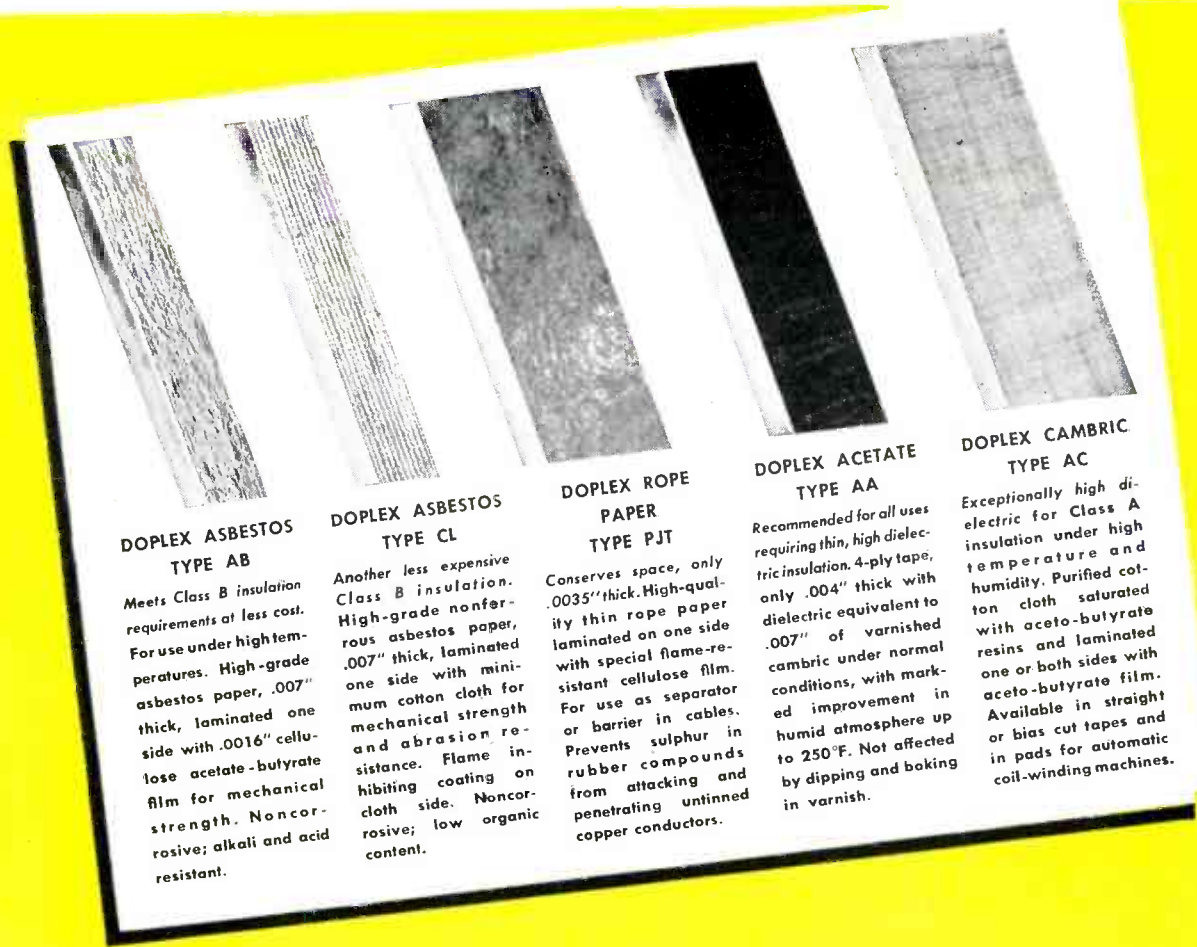

**DOPLEX ASBESTOS TYPE AB**

Meets Class B insulation requirements at less cost. For use under high temperatures. High-grade asbestos paper, .007" thick, laminated one side with .0016" cellulose acetate-butylate film for mechanical strength. Noncorrosive; alkali and acid resistant.

**DOPLEX ASBESTOS TYPE CL**

Another less expensive Class B insulation. High-grade nonferrous asbestos paper, .007" thick, laminated one side with minimum cotton cloth for mechanical strength and abrasion resistance. Flame inhibiting coating on cloth side. Noncorrosive; low organic content.

**DOPLEX ROPE PAPER TYPE PJT**

Conserves space, only .0035" thick. High-quality thin rope paper laminated on one side with special flame-resistant cellulose film. For use as separator or barrier in cables. Prevents sulphur in rubber compounds from attacking and penetrating untinned copper conductors.

**DOPLEX ACETATE TYPE AA**

Recommended for all uses requiring thin, high dielectric insulation. 4-ply tape, only .004" thick with dielectric equivalent to .007" of varnished cambric under normal conditions, with marked improvement in humid atmosphere up to 250°F. Not affected by dipping and baking in varnish.

**DOPLEX CAMBRIC TYPE AC**

Exceptionally high dielectric for Class A insulation under high temperature and humidity. Purified cotton cloth saturated with aceto-butylate resins and laminated one or both sides with aceto-butylate film. Available in straight or bias cut tapes and in pads for automatic coil-winding machines.

# VERSATILITY is a good Tape measure

DOPLEX tapes combine the electrical, mechanical and chemical properties of their basic materials to meet various insulating requirements, such as:

- Asbestos for resistance to high temperatures. (Types AB and CL)*
- Cellulose film for flame resistance and protection of untinned copper conductors. (Type PJT)*
- Aceto-butylate or cellulose acetate for acid resistance and high dielectric. (Types AB, AA, AC)*
- Purified cotton fibre for strength and abrasion resistance. (Types CL and AC)*

Widths are obtainable from one-eighth inch up, with a range of put-ups on universal cops and pads, for manual or mechanical application. Quick deliveries for priority orders.



THE **DOBECKMUN** C O .  
INDUSTRIAL PRODUCTS DIVISION • CLEVELAND 1, OHIO

Makers of "LEXEL" insulating tape and "DOBAR" laminated paper insulation

**WORDS CAN'T TELL THE STORY  
USE THE COUPON TO GET SAMPLES FOR YOUR OWN TESTS**

Please check samples desired and sign as indicated. Attach coupon to your letterhead and mail to The Dobeckmun Company, Cleveland 1, Ohio.

- Doplex asbestos: Type AB
- Doplex asbestos: Type CL
- Doplex rope paper: Type PJT
- Doplex acetate: Type AA
- Doplex cambric: Type AC

Name \_\_\_\_\_  
Title \_\_\_\_\_  
Company \_\_\_\_\_

# Jennings -RADIO-

VACUUM ELECTRONIC COMPONENTS



\* Y - PINENUT SERIES OF CAPACITORS  
PATENT APPLIED FOR



\* X - PEANUT SERIES OF CAPACITORS  
PATENT APPLIED FOR

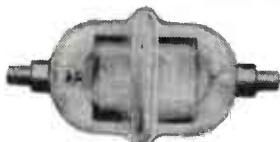

\* W - WALNUT SERIES OF CAPACITORS  
PATENT APPLIED FOR

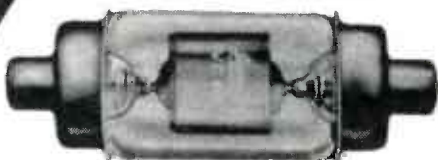

VC 50 - SERIES OF CAPACITORS

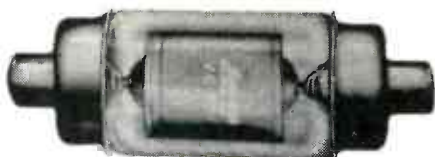

VC 250 - SERIES OF CAPACITORS



\* C - COCONUT CAPACITOR

Above sizes relatively in proportion

# Jennings -RADIO-

VACUUM ELECTRONIC COMPONENTS

**ANNOUNCES**

# 4\*

**NEW VACUUM  
CAPACITORS**

## THE CAPACITY RANGE AND SIZE OF JENNINGS HIGH VOLTAGE VACUUM CAPACITORS

COVER MANY NEEDS IN ADVANCED ELECTRONICS

FOR THE FIRST TIME VACUUM HIGH VOLTAGE CAPACITORS ARE AVAILABLE OVER A WIDE RANGE OF SIZES AND CAPACITIES

\* Y - PINENUT, 1-5 mmfd.,  
3500 Peak Volts, 7½ Amps.

\* X - PEANUT, 5-25 mmfd.,  
7500 Peak Volts, 20 Amps.

\* W - WALNUT, 6-50 mmfd.,  
20,000 Peak Volts, (Available up to  
32,000 Peak Volts), 20 Amps.

\* C - COCONUT, 50 mmfd  
50,000 Peak Volts, 60 Amps.

VC 50, 6-50 mmfd  
20,000 Peak Volts, (Available up to  
32,000 Peak Volts), 20 Amps.

VC 250, 50-250 mmfd  
20,000 Peak Volts, 60 Amps.

\* Four new units added to the wide range of sizes and capacities in Jennings vacuum Capacitors.

We welcome your inquiry and the opportunity to serve you.

WATCH JENNINGS FOR NEW DEVELOPMENTS IN THE FIELD OF SPECIALIZED VACUUM ELECTRONIC COMPONENTS.  
WRITE FOR BULLETIN E

JENNINGS RADIO MANUFACTURING COMPANY • 1098 E. WILLIAM ST. • SAN JOSE 12, CALIFORNIA

### "BO" POWER RELAY

The "BO" relay is an all-purpose double pole power relay. Like other Allied types it is ruggedly designed yet features compactness and minimum weight. This relay utilizes molded Bakelite insulation throughout. Contact rating is 15 amperes at 24 volts DC or 110 volts AC non-inductive. The "BO" relay can be furnished normally open, normally closed or double throw and is available for either AC or DC service. Weighs 4 ounces.

Height 1 7/8"; Length 1 3/4"  
Width 1 13/32"



### "DO" TYPES 3 and 4 POLE

The "DO" three and four pole relay is similar in function to the "BO" type described above. It supersedes the old three and four pole type and features such modifications as simplified terminal arrangements, adjustable contacts, and improved mechanical structure. By using molded Bakelite insulation throughout, greater electrical clearance is provided. Contacts are rated at 15 amperes at 24 volts DC or 110 volts AC non-inductive. Can be furnished normally open, normally closed, double throw and for AC or DC service as specified. Weight for three pole type 7 oz., four pole 7 1/2 oz.

Three pole Height 2 1/4"; Length 1 3/8"; Width 1 7/8"; Four pole Height 2 1/4"; Length 2 1/16"; Width 1 7/8".



## constant progress MARKS ALLIED RELAY DESIGN

Marking time or "resting on laurels" in no way reflects Allied's engineering and business philosophy. A specific control does a good job . . . but can it be improved? Allied engineers and field staff check its working performance . . . seek possibilities to better or broaden its usefulness.

Thus refinements, revisions and modifications in basic types of relays come about—as in the three and four pole "DO" and the all-purpose double pole "BO" types described herein. Keeping pace with the constant engineering progress of manufacturers whose products require electrical control . . . anticipating their requirements . . . epitomizes Allied's philosophy. Let your control problems become our engineering projects.



## ALLIED CONTROL COMPANY, INC.

GENERAL OFFICES: 2 East End Ave. (at 79th St.) New York 21, N. Y. Factories: New York City (2 East End Ave.)—Plantville, Conn. Chicago—4321 Knox Avenue, Chicago 41, Illinois. In California: Allied Control Co. of California, Inc. 163 J South Hope St., Los Angeles 15, Calif.

# PLUGS and JACKS

...for every known application!

Built in accordance with latest Signal Corps and Navy specifications, Amalgamated Plugs and Jacks are tropicalized to make them fungus resistant, waterproof and moistureproof when called for. Insulators of these components are designed to withstand extremes of temperatures for  $-67^{\circ}\text{F}$  to  $+167^{\circ}\text{F}$ , at humidities up to 100%. We also specialize in producing Plugs which will bear up under the high heat met in rubber molding cord sets.



**NOTE:** Amalgamated Engineers will gladly consult with you on the design and development of Plugs and Jacks for special applications — present or postwar.



## PLUG PL-55 and N.A.F. 1136-1

Long sleeve, two-conductor plug, mate to Jack JK-34-A. Withstands minimum of 60 cycles AC, potential of 500 volts effective, applied between any two terminals for not less than two seconds. Meets minimum insulation value of 2000 megohms between conductors at  $68^{\circ}\text{F}$  at humidities up to 100%.

## JACK JK-26, N.A.F. 215284-2

Two-conductor Jack, mate to PL-54. Tropicalized. Withstands 60 cycle AC potential of 500 volts effective, applied between any two terminals for not less than two seconds. Meets minimum insulation value of 2000 megohms between conductors at  $68^{\circ}\text{F}$ , at humidities up to 100%.



## PLUG, STYLE "A"

Two-conductor, special type plug for use with Neoprene or Buna S molded cords. Same specifications as PL-55.



## JACK JK-48

Light duty, two-conductor Jack, mate to Plug PL-291 and Plug 291-A.



## PLUG PL-204

Hand set. A special plug wherein both a modified plug, PL-55 and PL-68, are held in place by a phenolic case. Same specifications as PL-55 and PL-68.

## PLUG PL-54, PL-540, PL-354, N.A.F. 215285-2

Short sleeve, two-conductor plug, mate to Jack JK-26. Same specifications as PL-55.



## PLUG, STYLE "D"

Two-conductor, special type plug for use with Neoprene or Buna S molded cords. Same specifications as PL-55.

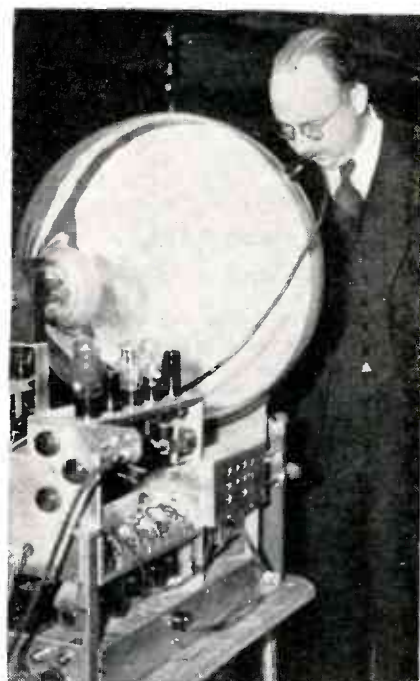

Fig. 2—Experimental large-screen cathode-ray tube and associated circuits for direct-viewing television receiver

pictures having greater than a 20-inch diagonal, direct viewing is impracticable. The following table compares present direct viewing with the projection systems.

Characteristic	Direct Viewing	Projection
Brightness (ft lamberts)	20	3.5
Contrast Viewing angle	35	17
angle	$\pm 80$	$\pm 15$
(degrees)		

Direct viewing provides sufficient brightness for viewing in a normally illuminated room. This fea-

AMALGAMATED RADIO TELEVISION CORP.

476 BROADWAY • NEW YORK 19, N. Y.



# Radio Out of a Hat!

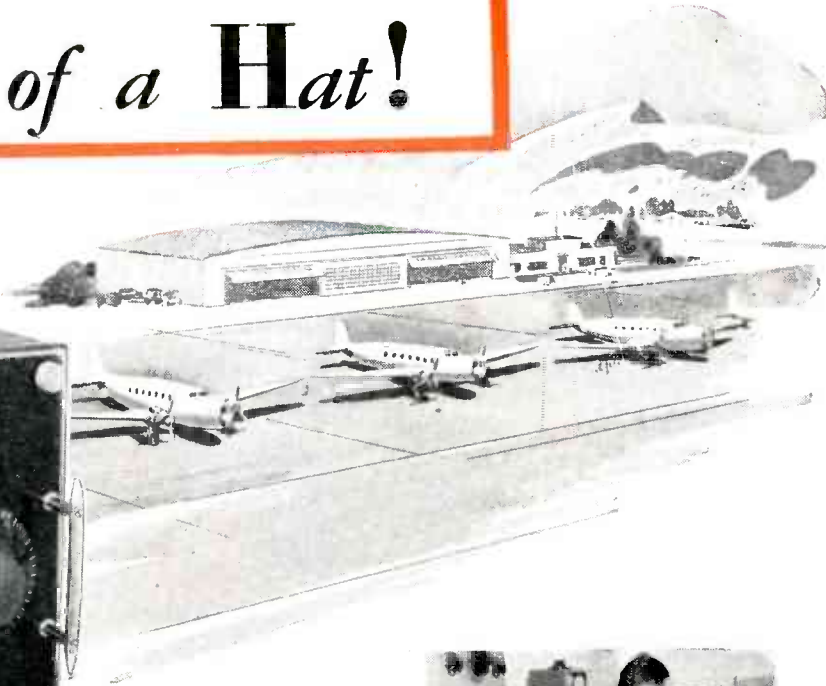

## 88 DAYS FROM DRAFTING BOARD TO FLIGHT LINE

Germany stunned the world in '39 with their *blitzkrieg*. At exactly the same time another *blitzkrieg* was quietly being made by the Canadians in this country. They needed airplanes and radio communication equipment—fast.

The airplanes they got...and the radios. There were less than 90 days left when Pacific Division got the go ahead for transmitters and interphone equipment that had not even been designed.

In 88 days Pacific Division designed—developed—and delivered a quantity of 100-watt master oscillator transmitters for low and high frequency...amplifiers for the interphone...and engineered and installed these and all other radio equipment in the Canadian airplanes.

We at Pacific Division would rather not accept any more orders that we have to pull out of a hat. But we are open for business, especially VHF Communication Systems in which we specialize, that demands experience, ability and resourcefulness. Your inquiries are invited.

© 1946, Bendix Aviation Corp.



VHF COMMUNICATION SYSTEMS



A new interpretation of simplified VHF, scheduled for early announcement, is the latest development of the company's radio engineering laboratory.



Quality in quantity is the keynote of all Pacific Division manufacturing processes.



Pacific Division's engineering ability is matched by its outstanding production facilities. Here future VHF equipment will be manufactured in volume.



PRODUCT OF Bendix AVIATION CORPORATION

OPERATING SIX VHF EXPERIMENTAL STATIONS

WOULD A

# 50% Assembly Savings

HELP YOUR PRODUCT BEAT POSTWAR COMPETITION?

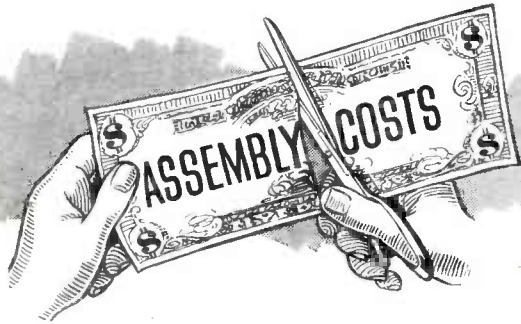

CUTTING ASSEMBLY COSTS IN HALF is nothing unusual for P-K Self-tapping Screws *the short cut fastening method!* Records of thousands of applications show frequent savings of 30 to 50%.

THERE'S NOTHING EXCEPTIONAL about such savings, either. In 7 out of every 10 jobs submitted for fastening survey, it was found that P-K Screws could eliminate tapping—speed assembly—lower costs—reduce spoilage—improve strength and rigidity.

WHY HANDICAP YOUR PRODUCT in the postwar market with needlessly high assembly costs? Change over now to the short cut fastening method—*before production starts!*

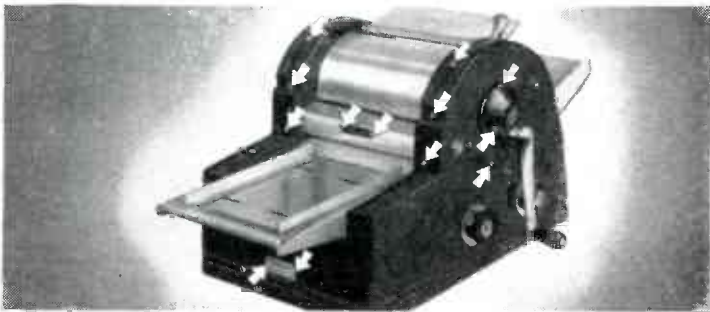

FASTENINGS TO HEAVY AND LIGHT STEEL, ZINC, ALUMINUM... WITH SAVINGS UP TO 40%

of time and labor... stronger assemblies... faster production. That is what Ditto, Inc., gained by using P-K Type "Z" and Type "U" Self-tapping screws for 52 fastenings on this duplicating machine. Now, their policy is "to use this short cut method wherever possible"... good advice for you!

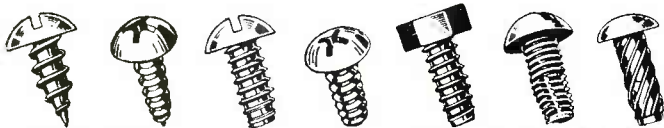

For Every Metal and Plastic Assembly

HERE'S HOW TO START ASSEMBLY SAVINGS WHEN YOU START PRODUCTION



**1.** QUESTION EVERY FASTENING in your plans. Ask—"Can it be done the simpler way—with P-K Self-tapping Screws?"—before you O.K. more complicated methods.



**2.** WITH THE "USERS' GUIDE" (free to assembly planners on request), find out how and where you can use P-K Self-tapping Screws to eliminate tapping, costly inserts in plastics, awkward bolting and other "slowdown" methods.



**3.** ASK A P-K ASSEMBLY ENGINEER to go over your plans with you—to make sure you don't miss any chance to save. You'll find his advice unbiased, because Parker-Kalon makes all types of Self-tapping Screws. Or, send assembly details for recommendations. Parker-Kalon Corporation, 208 Varick St., New York 14, New York.

**PARKER-KALON**  
Quality-Controlled  
**SELF-TAPPING SCREWS**



more efficient  
... in miniature



ACTUAL SIZE

When the wind blew hard, it was not unusual to put two husky men on the wheel of an old "wind-jammer." Yet today one man easily steers a vessel ten times the tonnage, in any weather, with a wheel about quarter the size. Modern engineering has made this possible.

So it is with miniature electronic tubes. They are not only smaller, but they offer many other advantages when used in high-frequency circuits. Moreover the shorter elements of miniatures are more rigid and are less prone to distortion as the result of vibration or shock.

Manufacturers of radio sets and other electronic

devices will find the use of miniatures of greatest aid in reducing the size and improving the function of their new equipment. TUNG-SOL engineers will consult with manufacturers in the designing of circuits and in the selection of tubes. Consultations are always held in strictest confidence.

**TUNG-SOL**  
*vibration-tested*  
**ELECTRONIC TUBES**



**TUNG-SOL LAMP WORKS INC., NEWARK 4, NEW JERSEY**  
*Also Manufacturers of Miniature Incandescent Lamps, All-Glass Sealed Beam Headlight Lamps and Current Intermittors*

# Meet...



## the **Conant** family of instrument rectifiers

It's a distinguished family, this Conant clan of instrument rectifiers. They have taken all the mystery out of the rectifier business.

Over ninety per cent of all rectifier requirements are served by 12 types—4 basic assemblies in 3 series. These 3 series are the three members of the Conant family shown above. Special types, however, can be developed as needed, and you'll find Conant ready to cooperate.

Conant rectifiers are available from stock for immediate delivery on priorities of AA5 or higher. MRO, CMP, V3 or MILITARY END USE classifications are recognized.

If you have no priority: File form WPB 547 for your stock requirements. You'll be glad to know this Conant family of rectifiers. They're doing a great wartime job.



*Instrument Rectifiers*

**ELECTRICAL LABORATORIES**

6500 O STREET, LINCOLN 5, NEBRASKA, U. S. A.

29 Vesey St., New York 7, New York  
85 E. Gay St., Columbus, Ohio  
600 S. Michigan Ave., Chicago 5, Ill.  
1215 Harmon Pl., Minneapolis 3, Minn.

2017 Grand Ave., Kansas City 8, Mo.  
1212 Camp St., Dallas 2, Texas  
378 Boulevard N. E., Atlanta, Ga.  
4018 Greer Ave., St. Louis, Mo.

1526 Ivy St., Denver, Colo.  
4214 Country Club Dr., Long Beach 7, Cal.  
Export Div., 89 Broad St., N. Y. 4, N. Y.  
50 Yarmouth Rd., Toronto, Canada

ture plus the wider viewing angle makes direct viewing preferable for the size images that can be obtained by this method, especially in the home. The limits used in determining the viewing angle were the angles from the normal at which 50 percent of the normal brightness was received.

The lower accelerating voltage of direct-viewing tubes simplifies tube manufacture, and increases tube life over the life of projection tubes by a factor of about two. Spot size is small enough for full resolution by the tube of the transmitted 525 lines (it was stated that this is not possible in the 5-inch projection tubes where great light intensity necessitates a proportionally larger spot).

Direct viewing has the advantage that all the focusing is done electrically, there is no optical alignment and focusing, and there is not the optical loss of light from surface reflection and dust absorption. The direct-viewing system is simpler and thus cheaper, although it has the disadvantage of a curved viewing screen.

### *Television Receivers*

From the customer's viewpoint, the choice between direct and projection viewing will depend on the bulk of the receiver, especially for comparable sized images. The large tube necessary for direct viewing can be mounted so as to be retractable. Possibly the large tube could be incorporated in a bulky piece of furniture but this has the drawback that the complete receiver is no longer a package unit. Projection requires a second piece of furniture—the screen, nevertheless the bulk size is less than with direct viewing and there is the possibility of using the room wall for the screen.

In forcing the brightness of television-tube images, white takes on a hue due to the difference in persistence of the several pigments used to obtain white light from the screen. This constitutes chromatic aberration in the cathode-ray tube, and is most likely to be encountered in tubes for projection systems.

The loss of highlight brightness

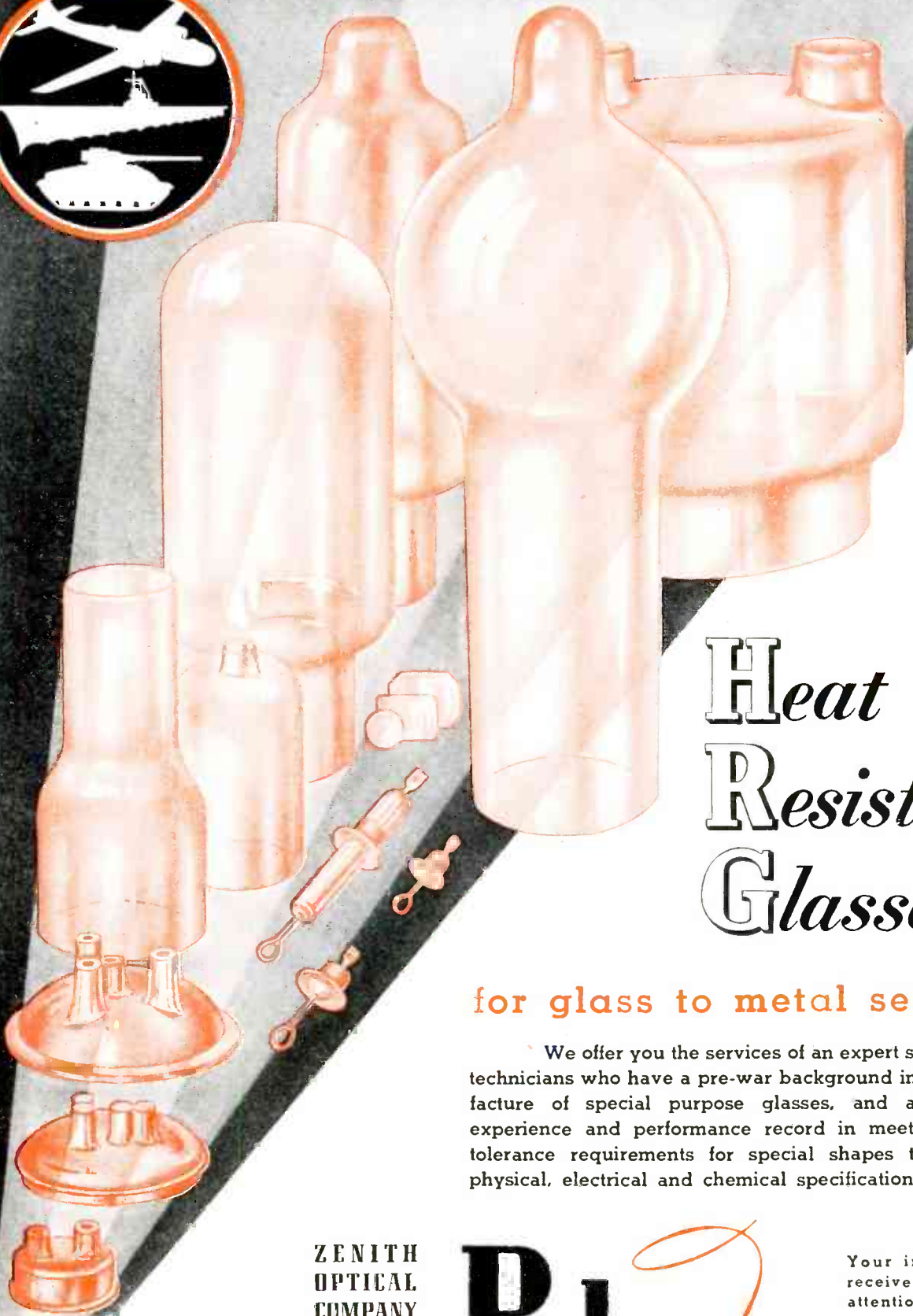

# Heat Resistant Glasses

for glass to metal sealing

We offer you the services of an expert staff of glass technicians who have a pre-war background in the manufacture of special purpose glasses, and a war-born experience and performance record in meeting critical tolerance requirements for special shapes to exacting physical, electrical and chemical specifications.

ZENITH  
OPTICAL  
COMPANY

*A unit of*

**Polan**  
*Industries*  
HUNTINGTON 19 • WEST VA.

Your inquiry will  
receive our prompt  
attention.



IS IT LATER THAN YOU

THINK?



Oiljak, like other American manufacturers, continues to devote all its facilities to the production of war material, to speed the approaching day of victory.

Yet, at the same time, we consider it no less our duty to plan for the future, to do our part in easing the change-over to a healthy industrial economy during the competitive peacetime years that lie ahead of American industry.

Oiljak offers you complete manufacturing facilities with up-to-date machines operated by men whose production record on war contracts compares favorably with normal peacetime costs; a record achieved by a minimum of rejections, a steady streamlined flow of work and materials through the plant, and a special assembly-line technique for which Oiljak is famous.

So before you set up the manufacturing procedure for *your* peacetime products, it may well be worth your while to get acquainted with all the facilities which Oiljak can offer you.



MACHINING · STAMPING · WELDING · PLATING · FINISHING · ASSEMBLING

M E T A L M A N U F A C T U R E R S

**THE OILJAK MANUFACTURING Co., INC.**

MONTCLAIR, NEW JERSEY

THE JOB COMPLETE FROM BLUEPRINT TO FINISHED PRODUCT

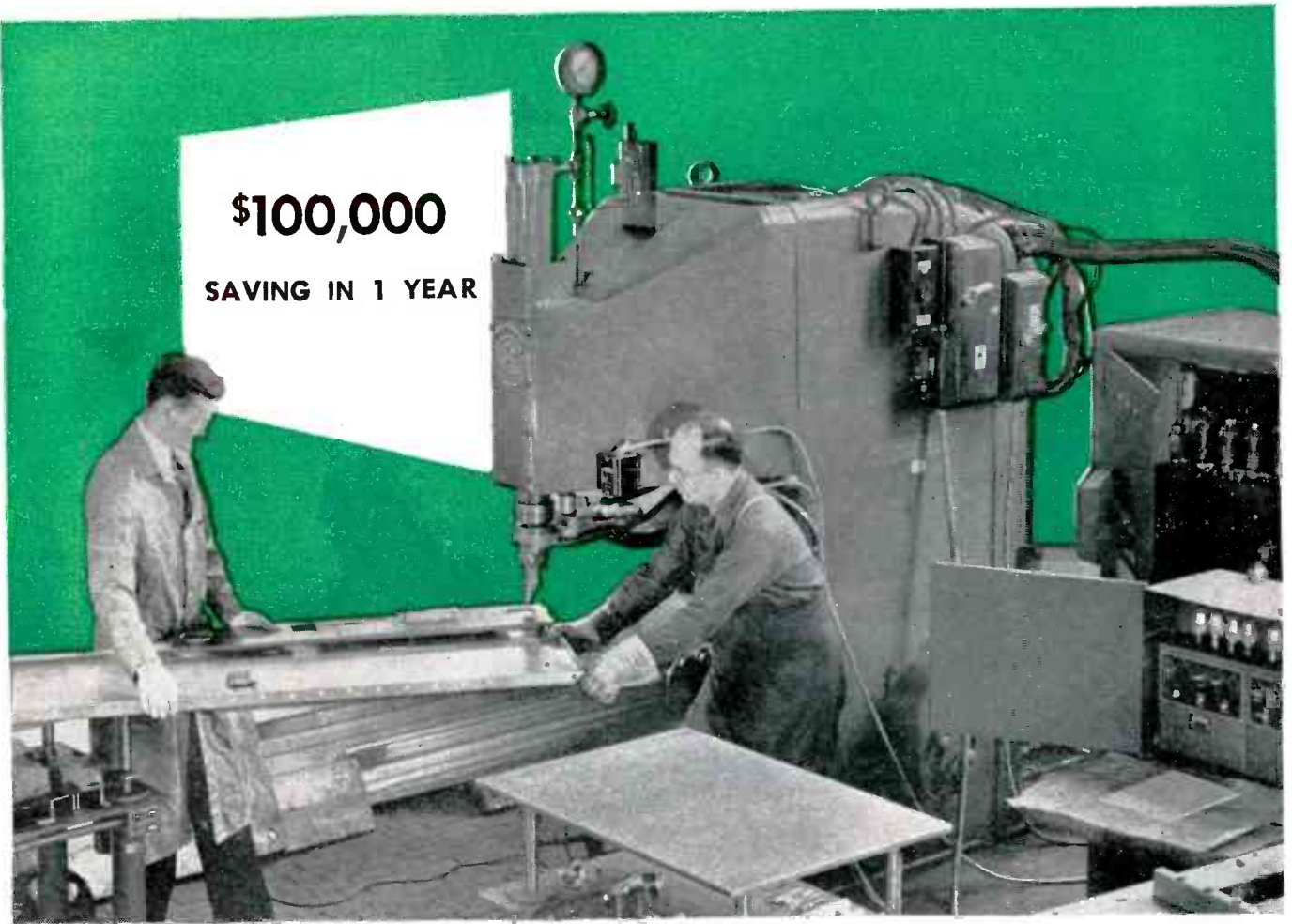

***here's what came out . . .  
when electronics went in***

A manufacturer of metal cabinets recently installed resistance welding with electronic control—to replace other forms of fabrication.

Here's what came *out* of his fabrication costs in one year: *600 tons of steel, 10,000 man-hours of labor, 3,000 pounds of welding rod.* The total saving amounted to \$100,000.

The reasons? Resistance welding with precision electronic control permitted use of lighter gauge stock in the whole structure—with strength and

tolerances maintained. This, in turn, permitted better-planned shearing that greatly reduced scrap losses.

Resistance welding control is but one of the many ways electronics is serving industry as a production tool—speeding fabrication, cutting costs, improving products.

For full information on electronic applications for your industry, consult your nearest Westinghouse office. Or write Westinghouse Electric Corporation, P. O. Box 868, Pittsburgh 30, Pa. J-91080



**ELECTRONIC CONTROL** for resistance welding equipment provides accurate control of weld time, heat and timing sequence. Through the precision of electronic tubes, accurately controlled electric current may be sent stabbing through metal as many as 1,800 times per minute.

TUNE IN JOHN CHARLES THOMAS, SUNDAY—2:30 EWT, NBC.



**Westinghouse**  
PLANTS IN 25 CITIES . . . OFFICES EVERYWHERE

*Electronics at Work*

ELECTRONIC EQUIPMENT FOR INDUSTRY AND HOME • ELECTRONIC TUBES • RADIO AND TELEVISION

in projection systems was said to be a definite drawback, giving reduced contrast. The production of a larger image by projection than can be obtained directly was thought undesirable because the lack of contrast gives the impression of poor definition.

#### Television Reception

Transmission problems at the higher frequencies used for television necessitate placing antennas where the radiation is available. Possible means of increasing coverage and improving reception are the use of repeaters, directional arrays rotating in direction toward the station automatically as that station is tuned in at the receiver, and—for apartment houses—a multiple array receiving antenna feeding a booster amplifier from which r-f energy from all stations is piped along coaxial lines to receivers.

#### Color Television

The use of absorption color disks appears to be the most satisfactory color system. At present, rotating color disks synchronized at the receiver with corresponding disks at the transmitter are used, but the system can be made completely electronic. Using a 10 mc-bandwidth, 525 line, three-color transmission giving 25 percent better horizontal definition than the present black and white television is feasible. Disks now rotate silently.

The loss of light by color filtering may be compensated by using a black translucent screen. The three-color system gives, if not perfect color rendition, at least a pleasing effect. Use of the black screen constitutes the addition of the black plate used in four color printing. The black screen also makes viewing in an illuminated room possible, the screen being black in the absence of video illumination even if it is illuminated by room light. A direct-viewing, seven-inch, flat-faced tube with a plastic magnifying lens to give an apparent ten-inch image has been used. Either of the two previously described projection systems can be used.

During the question period, inquiry was made concerning the use

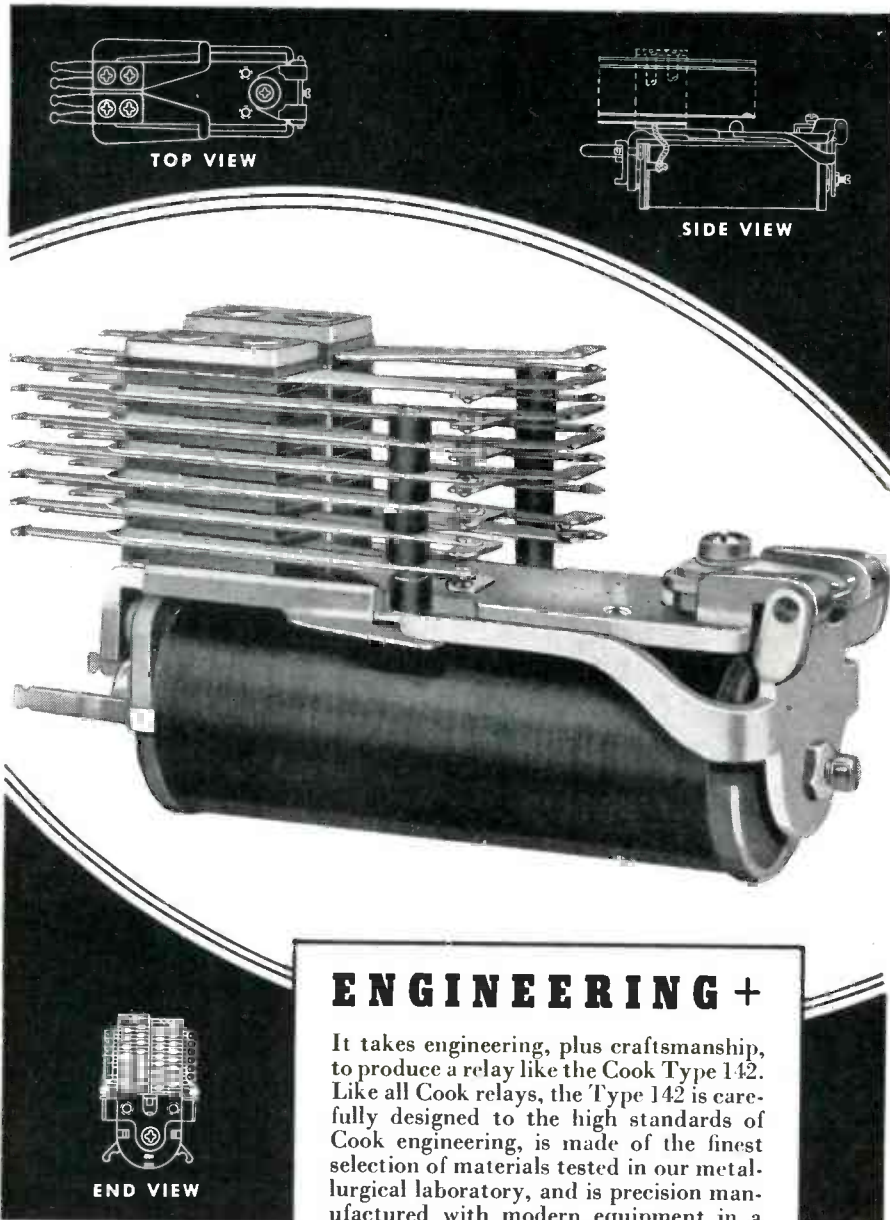

## ENGINEERING +

It takes engineering, plus craftsmanship, to produce a relay like the Cook Type 142. Like all Cook relays, the Type 142 is carefully designed to the high standards of Cook engineering, is made of the finest selection of materials tested in our metallurgical laboratory, and is precision manufactured with modern equipment in a model plant. However, it is a relay like this, representing almost the maximum number of spring pile-ups, wherein the qualities of Cook craftsmanship are so predominantly apparent. It is the careful assembly, adjusting of springs, and inspection and testing that produces the unseen qualities of Cook relays.

The Type 142 is a standard type relay operating at 48 Volts, D.C. Armature is of Armco magnetic iron, springs of nickel silver, with bakelite insulators baked at 150 degrees for 100 hours, and phosphor bronze bearing pin. The contacts are palladium and contact combination consists of 11 Forms "A", and one each of Forms "B", "C" and "D".

*A Product of the Electro-Magnetics Division of*

2700 SOUTHPORT  
AVENUE

CHICAGO  
14, ILLINOIS

**COOK ELECTRIC**



*Company*



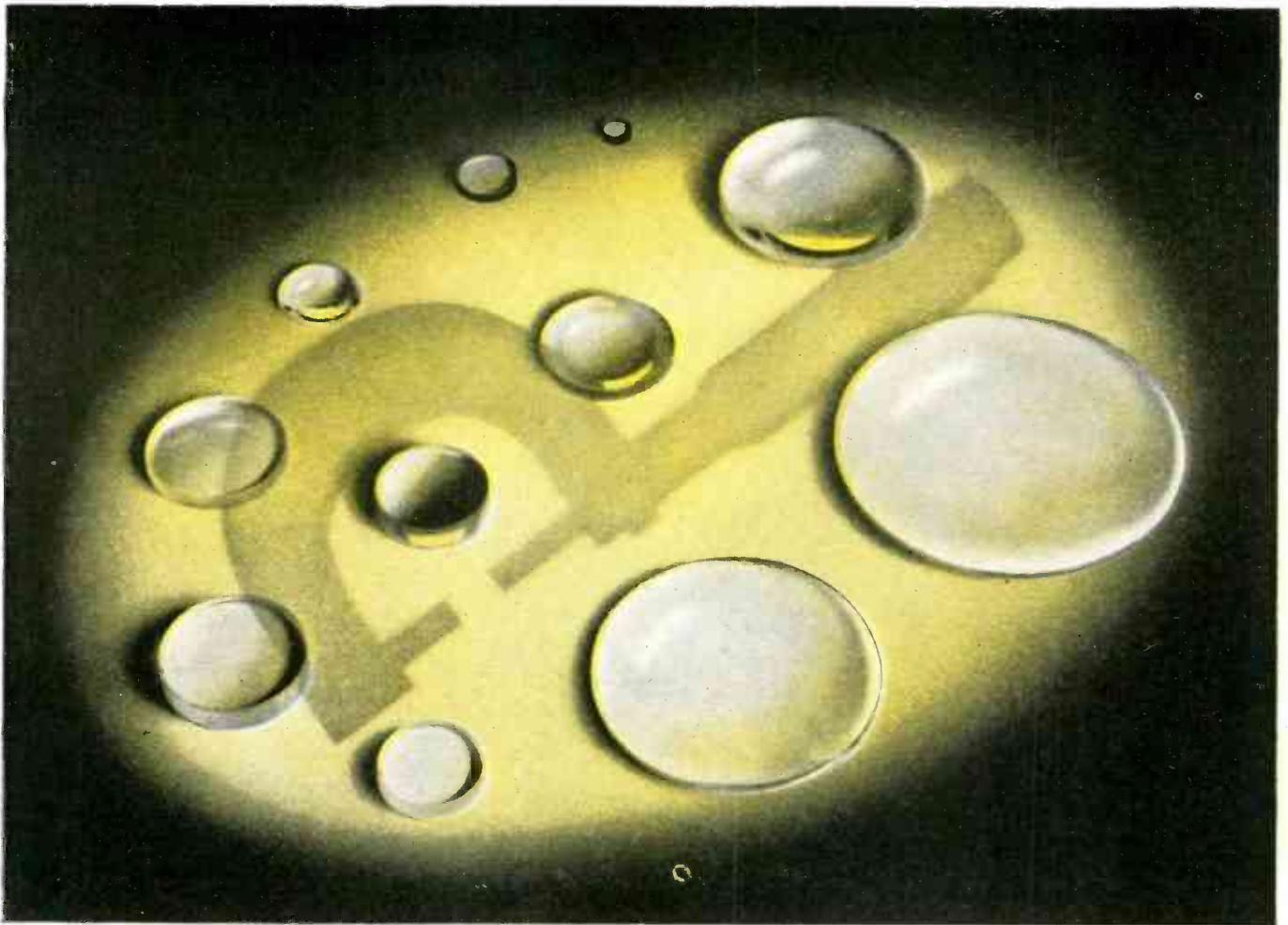

## How precise should a lens be?

Close tolerances are an old story to our compact group of optical technicians. All through the war program they have been producing optics to the severest precision standards for such exacting customers as the Ordnance Department of the United States Army and the Bureau of Ordnance of the United States Navy.

As reconversion progresses many needs arise for optics which do not require such close tolerances. These, too, can be supplied by us at economical prices. For we have built up a volume production line in which

newly-designed machines cut costs. Every job that goes through our plant is done to order for specific requirements. This means that you get the precise degree of accuracy you need at the best possible price.

Your work receives primary consideration in our plant. We make no complete products of our own but specialize in supplying custom-built optics to other manufacturers.

Our technicians will be glad to help you with the design and development of optical systems.

*for precision OPTICS come to*

**AMERICAN LENS COMPANY, INC.**

45 Lispenard Street, New York 13, N. Y.



LENSES • • • PRISMS • • • FLATS • • • REFLECTORS

# Simplify Your Access Panel and Door Assemblies...

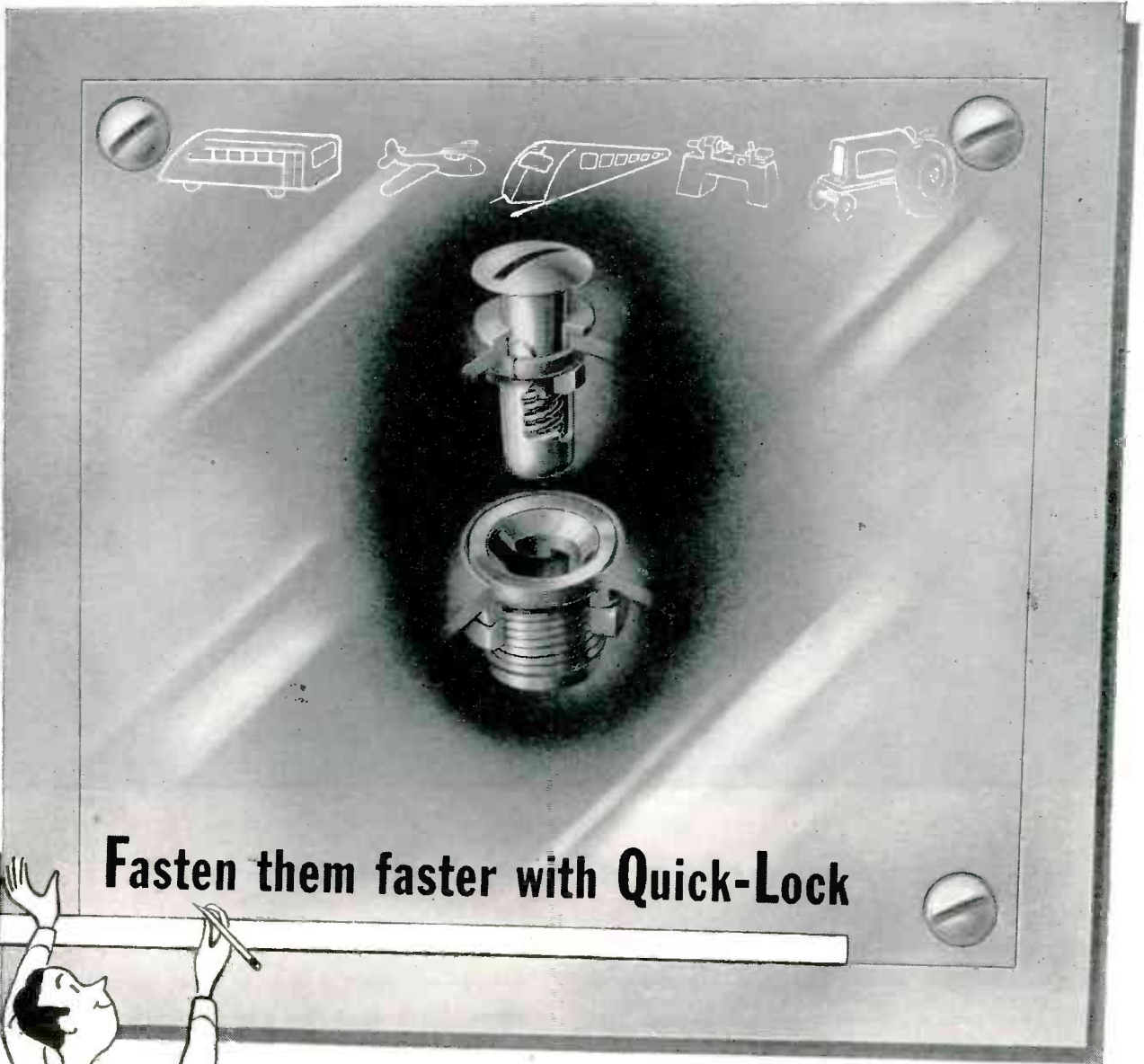

Fasten them faster with Quick-Lock

Fastening removable access doors and panels need not be a laborious and costly production or assembly operation—not if they're fastened with QUICK-LOCK.

Designed for simple installation, QUICK-LOCK requires no special tools. It speeds up mounting and demounting detachable panels with only a 90° turn required to lock and unlock it *in a jiffy*.

The flexible mounting and tapered stud makes QUICK-LOCK ideal for assembling curved sheets and insures a tight fit when locked. Stud is self-ejecting when unlocked. Minimum deflection is assured—only initial loads are carried by the helical spring. Solid supports take up increased loads.

Industrial and agricultural equipment manufacturers would do well to analyze the cost-saving features of QUICK-LOCK's simple design. A good way would be to call in a Simmons Engineer and discuss the economy of a QUICK-LOCK installation as compared to your present fastening method. Why not send for him today?

## SIMMONS FASTENERS

SIMMONS FASTENER CORPORATION • 1750 NORTH BROADWAY, ALBANY 1, N. Y.



## UNEXCELLED FOR ALL VIBRATOR INSTALLATIONS

Long experience in designing and manufacturing vibrators has given us the knowledge to build vibrators that are unexcelled for every purpose.

Our engineers, both before and during the war, have had wide experience in developing vibrators to meet rigid specifications. Their knowledge and experience have led them to completely engineer each vibrator—not just make an adaptation from some other type.

The high quality and long life of RADIART VIBRATORS have been demonstrated in millions of installations.

Why not let our engineers help you by designing RADIART VIBRATORS AND VIPOWERS for your specific requirements?

Manufactured by the makers of the famous RADIART Rust Proof Aerials and Radiart V i p o w e r Units.

Write for information on these two products.



# Radiart Corporation

3571 W. 62nd STREET

Export Division  
25 Warren St., New York 7, N.Y.

CLEVELAND 2, OHIO

Canadian Office  
455 Craig St., W., Montreal, Canada



60 DEGREE

Horizontal

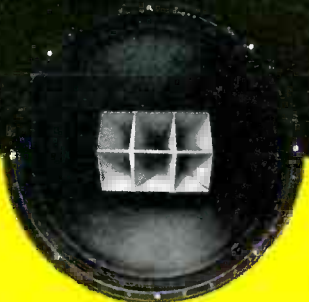

## AREA OF DISTRIBUTION

The new amazing Altec Lansing multi-cellular Duplex Speaker provides up to 1200% increased area of quality sound distribution in the horizontal plane. Horizontally the Duplex delivers a sixty degree angle of distribution, or twelve times the area distribution at high frequencies as compared to single unit speakers of comparable size. Another reason why the DUPLEX is the SPEAKER that REVOLUTIONIZES the methods of sound REPRODUCTION.

SEND FOR BULLETINS

# ALTEC

LANSING CORPORATION

1210 TAFT BLDG., HOLLYWOOD 28, CALIF.  
250 WEST 57 STREET, NEW YORK 19, N. Y.  
IN CANADA: NORTHERN ELECTRIC CO.

of light valves. It was stated that work on such systems was being done elsewhere, but that definition and contrast did not compare to that obtainable from cathode-ray tubes. The light source can be as bright as needed. (see Projection Systems for Theater Television, ELECTRONICS, p 218, May 1945.)

• • •

## Anti-Fade Antenna System

A DESCRIPTION of an anti-fade antenna system used for reception of a station at Droitwich, England before the war is included in a paper by P. Adorjan, of Rediffusion Ltd., appearing in the *Journal of the British Institution of Radio Engineers* (9 Bedford Square, London, W.C. 1) for Jan-Feb, 1945. Although the paper discusses some of the engineering aspects of audio-frequency wire broadcasting it incorporates the subject of antennas in describing the equipment used at remote receiving stations that demodulate an r-f signal from a central main station (such as Droitwich) and supply local subscribers over an a-f line. Such wire broadcasting has been developed in Great Britain during the past 15 years and by 1943 was subscribed to by about half a million license holders.

For reception of Droitwich, two antennas were placed in a line pointing in the direction of Droitwich, a half-wavelength (750 meters) apart. Halfway between these two, a middle antenna was installed, and the output of the two outer antennas combined through mixer amplifiers.

Phases and amplitudes are so adjusted that the direct ray received on the two outer antennas cancels at the junction point of the two outer antenna mixer units. The output of such a mixer unit will contain, therefore, a signal due to indirect ray only. This output is then mixed with the output of the middle antenna unit. Amplitudes and phases are so adjusted that the final output contains the signal due to direct ray from the middle antenna only.

The use of this system results in a satisfactory signal being obtained

## WIRE, RIBBON and other METAL PRODUCTS

- Smaller than Commercial Sizes
- Closer than Commercial Tolerances

### PLATINUM • RHODIUM • IRIIDIUM PALLADIUM • RUTHENIUM and ALLOYS

Commercial Purity and High Purity  
WIRE, SHEET, FOIL, TUBING

Wire for Resistance Thermometers

Rhodium Electroplating Solutions

Platinum for Electronic Tubes

Rhodium First Surface Mirrors

Alloys for Contact Points

Wires for Detonator Fuses

Dental Metals and Alloys

Wires for Thermocouples

Tubing for Ink Devices

Wire for Pirani Gauges

Spark Plug Electrodes

Wollaston Wire

Duro Palladium

### BASE METALS • RARE METALS PRECIOUS METALS and ALLOYS

Galvanometer Suspension Strips

Platinum Covered Grid Wire

Gold Covered Silver Wire

Gold Cyanide for Plating

Special Melts and Alloys

Gold Covered Grid Wire

Small Spring Ribbon

Electroplated Wires

Ribbon, All Metals

Molybdenum Ribbon

Tungsten Ribbon

Filament Ribbon

Filament Wire

Fuse Wire

Grid Wire

Write for List of Products and Data

## SIGMUND COHN & CO.



44 GOLD STREET NEW YORK 7



**No Brass Hats  
Here --  
JUST BRASS TACKS!**



**O**URS is a moderate-sized, compact organization in which everyone from the chief executives to the kid who runs the blue print machine is dedicated to just one purpose. That purpose—to design and build efficient, dependable Radio Transmitting Equipment—our exclusive specialty.

We have been at it successfully since 1922—long enough to gain genuine, practical

know-how in every phase of the business. That experience, plus engineering ability and precision workmanship, add up to the kind of Equipment which appeals to Engineers and Station Managers alike.

Let us tell you more about GATES Transmitting Equipment—and about the GATES Priority System for Prompt Post-War Delivery! Write today!

**GATES RADIO CO. • QUINCY, ILLINOIS**

## **GATES ONE KILOWATT BROADCAST TRANSMITTER**

This new Transmitter, utilizing many wartime developments, will meet the exacting demands of peacetime broadcasting. Its proven dependability—plus its modern, streamlined appearance—fit it perfectly into tomorrow's Radio Station. Accurately engineered, with all parts conveniently accessible. The pressure-type cabinet keeps out dust and helps assure cool operation. High fidelity performance. Detailed bulletin on the GATES 1 KW Transmitter will soon be available.

### **PROGRESS REPORT**

Wartime limitations prohibit the sale of new broadcasting equipment without priority. Hence the above equipment is presented only to familiarize you with another new GATES development.



**GATES RADIO CO. QUINCY, ILLINOIS**

**EXCLUSIVE MANUFACTURERS OF RADIO TRANSMITTING EQUIPMENT SINCE 1922**

**LOW**

**FREQUENCIES**

*Actual Size*

**ACCURACY TO 1/1,000th of 1%**

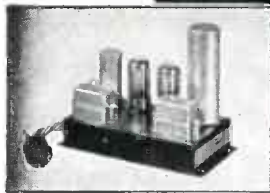

**TOP**  
**FREQUENCY STANDARD**  
*(60 cycle) for use with external power supply*

**CENTER**  
**CHRONOGRAPH**  
*Records time intervals with resolution to .001 second*

**BOTTOM**  
**FREQUENCY STANDARD**  
*(120 cycles) with self-contained power supply*

These tuning forks which include new engineering principles, provide frequencies from 120 to 1,000 cycles directly with an unqualified guarantee of accuracy to 1 part in 100,000 over a wide temperature range. (Better than 1 second in 24 hours). Closer tolerances are obtainable on special order.

These tuning fork assemblies are available only in single or multi-frequency instruments of our own manufacture which are de-

signed to test, measure or control other precision equipment by mechanical, electrical, acoustical or optical means.

The dependability of these frequency standards is being demonstrated for myriad purposes in all climates and under all working conditions.

If you have need for low frequency standards of exceptional accuracy, your inquiries are invited.

**American Time Products, Inc.**

**580 Fifth Ave.**

**New York, N. Y.**

*Dist. of Western Electric &*



*Watch-rate Recorders*

# Good connections

**- AND LOTS OF 'EM!**

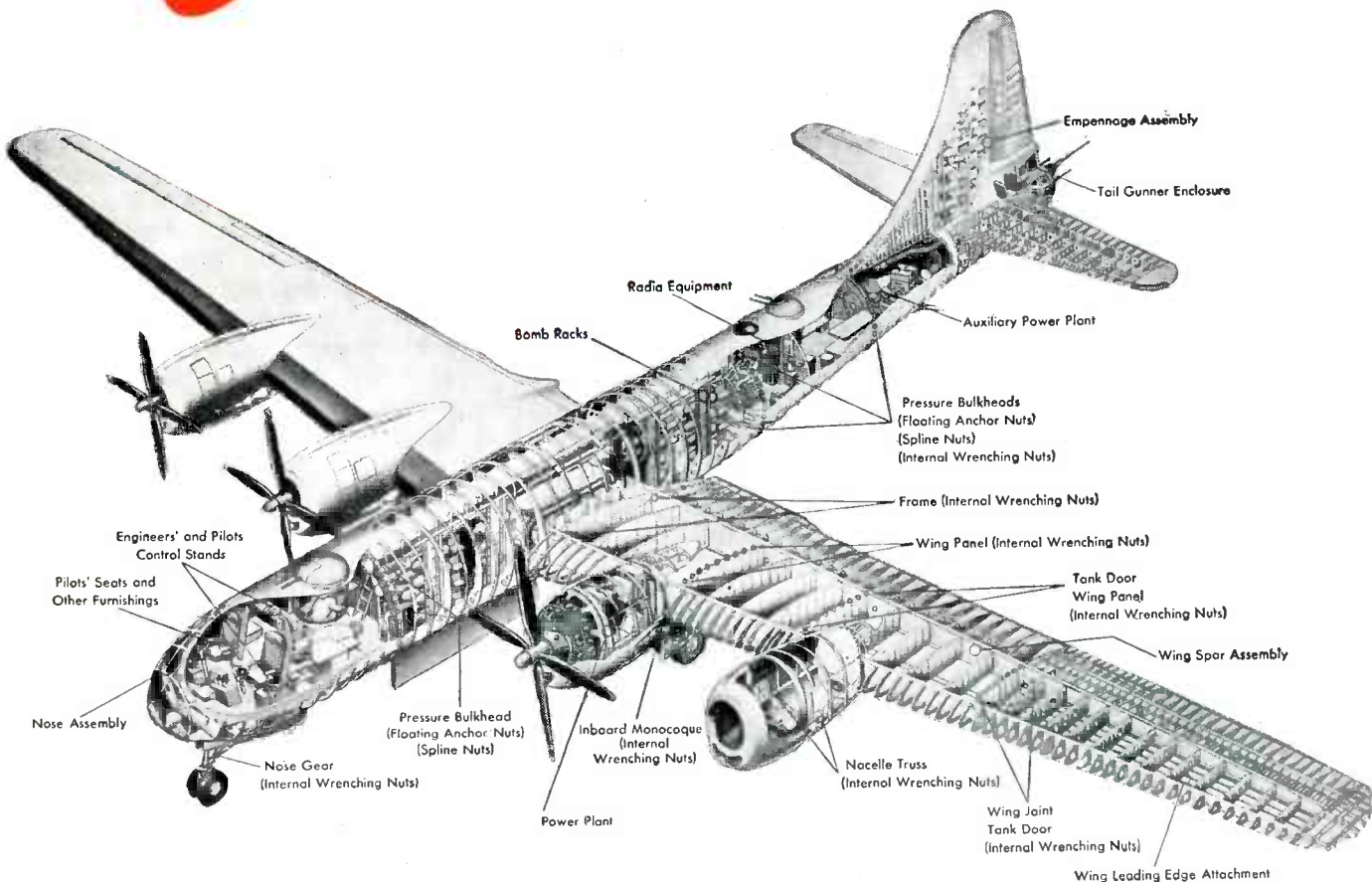

## ELASTIC STOP NUTS ON THE B-29

WITH more than 200 separate electric motors, elaborate radio and other communications and detecting equipment, landing lights, other lighting installations and other related equipment, it's no wonder that the giant Superfortress, the great Boeing B-29, is widely known as the "all-electric" plane.

And it is highly significant that many of the 75,000 Elastic Self-Locking Stop Nuts in a single B-29 are used to guarantee tight, trouble-free connections throughout the various electrical and electronic installations.

No frying noises, no spotty reception, no broken transmission, no light failures, no door-jamming, no fatal defects in critical

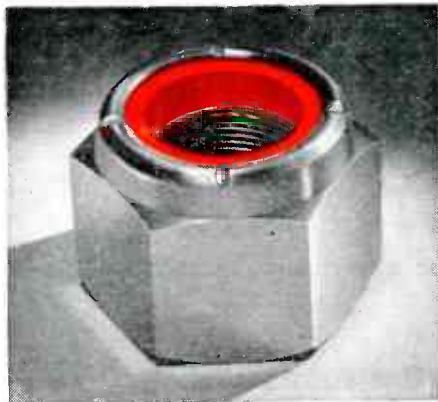

detecting apparatus—not from loose nuts, when the famous red-collar nuts are used as they are on the Superfortress.

Better performance from better products can be certified when "red-collar control" is given both products and production machinery, because Elastic Stop Nuts positively will not shake loose!

They hold their place. Yet they are easy to remove, and can be used over and over again.

For firm, hold-tight connections in electrical and electronic equipment, specify the nut with the red collar, the Elastic Self-Locking Stop Nut.

**LOOK FOR THE RED COLLAR  
THE SYMBOL OF SECURITY**

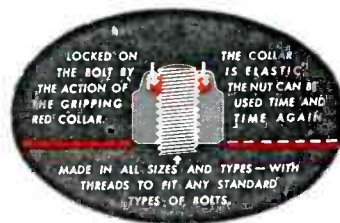

**ESNA**  
TRADE MARK

**ELASTIC STOP NUT CORPORATION OF AMERICA**

Plants at: Union, New Jersey and Lincoln, Nebraska

Sales Office: 1060 Broad Street, Newark 2, New Jersey

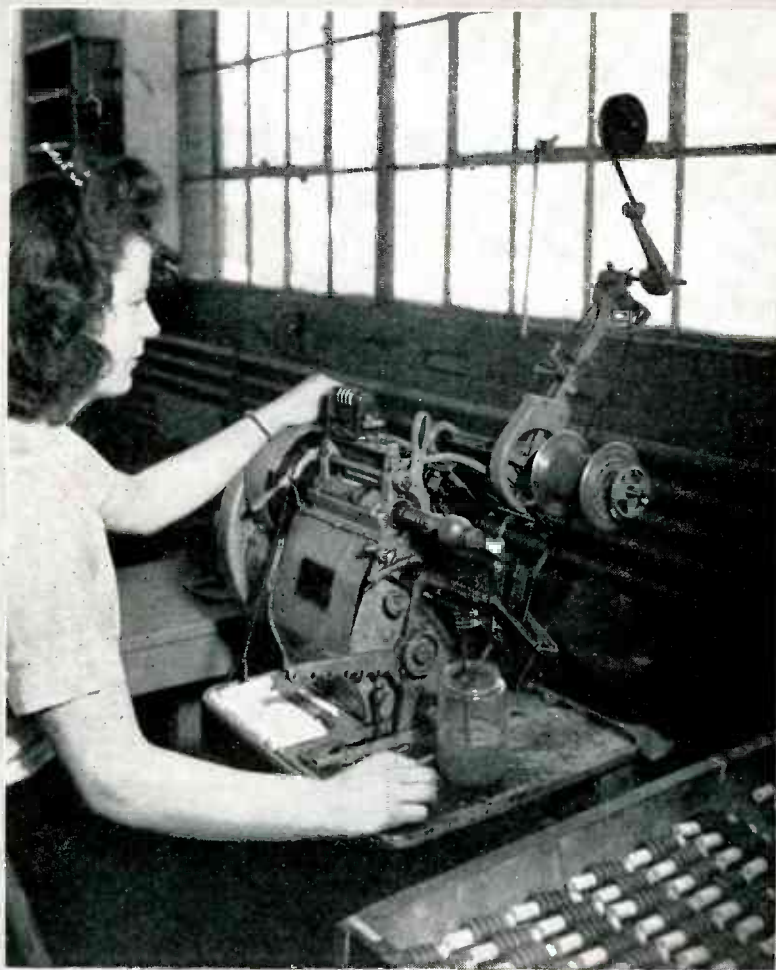
No. 4 of  $\alpha$  Series

## MODERN COIL WINDINGS

The "Honeycomb" or Universal Lattice Coil is still a popular winding in radio frequency circuits or as R. F. Chokes.

We can furnish this type of winding on tubes, dowels, resistor forms and iron slugs to close inductance tolerances and conductor sizes from #18 to #40.

### COTO-COIL CO., INC.

COIL SPECIALISTS SINCE 1917

65 PAVILION AVE.

PROVIDENCE 5, R. I.

almost free from distortion due to fading, where ordinary radio reception gives almost unbearable distortion. The system has applications where the direct and indirect rays arrive at comparable strength, which was the case with Droitwich before the war in many districts. The system has its limitations, inasmuch that it will only eliminate indirect rays arriving at one angle. Small variations in signal strength of the output of the anti-fade presumably were due to some secondary reflections, but in practice it was found that in the particular places where such apparatus was used the effect of these secondary reflections was negligible. Practically no AVC is required with a receiver following an anti-fade antenna system.

• • •

### Electron-microphotography of Atoms

THREE-DIMENSIONAL electron micrographic technique, besides giving a more realistic appearance to the surface being studied through an electron microscope, extends the lower limit of visibility. Before a joint meeting of the Sigma Xi societies of Case School of Applied Science and Western Reserve University and the Cleveland Physics Society, Robley C. Williams and Ralph W. G. Wyckoff of the University of Michigan publicly explained the technique and showed micrographs that they had obtained by it.

Simply passing electrons through the sample to be studied results in a silhouette picture the densities of which are proportional to the thickness of the sample. Shallow surface contours and minute objects can not readily be observed by this method because of the limitation in contrast of the resulting picture, nor does this method take full advantage of the resolving power of the electron microscope.

Electrically vaporized metals, usually gold, are deposited in a vacuum chamber on the sample—if it is non-metallic, or on a plastic replica made from an impression—if it is metallic. The metal vapor is sprayed on the sample from an oblique angle with the result that



DESIGNED AND ENGINEERED AT NO. 1 PLASTICS AVENUE

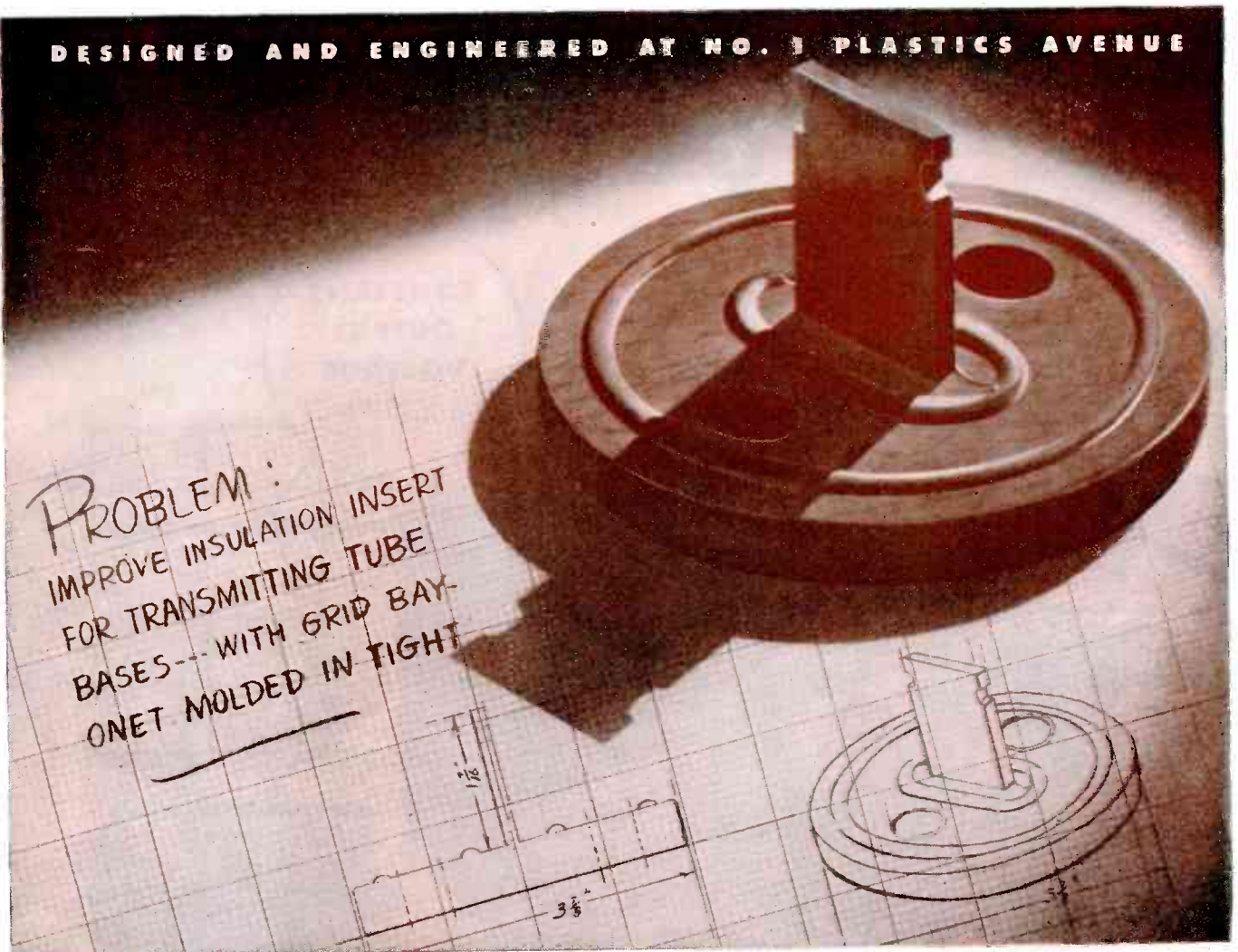

## G-E MYCALEX—BASIC FOR HIGH FREQUENCY INSULATION

● This is an insulation insert for bases of high frequency radio transmitting tubes.

It is molded by G.E.'s complete plastics service from G-E mycalex . . . compound of glass and powdered mica with a unique combination of properties.

G-E mycalex was specified for its excellent mechanical strength, high frequency insulation characteristics, and because the grid bayonet could be molded in tight.

To improve *your* electrical components, thoroughly investigate the possibility of utilizing G-E mycalex.

G-E mycalex . . . in standard sheets and rods or molded to your design . . . is available to all manufacturers. For information, write to Section S-91, Plastics Division, General Electric Co., 1 Plastics Avenue, Pittsfield, Mass.

Hear the General Electric radio programs: "The G-E All-Girl Orchestra" Sunday 10 P.M. EWT, NBC. "The World Today" news every weekday 6:45 P.M. EWT, CBS. "G-E House Party" every weekday 4:00 P.M. EWT, CBS.



### G-E MYCALEX

#### A Unique Combination of Properties

1. High dielectric strength
2. Low power factor
3. Prolonged resistance to electrical arcs
4. Chemical stability—no deterioration with age
5. Dimensional stability—freedom from warpage and shrinkage
6. Imperviousness to water, oil, and gas
7. Resistance to sudden temperature changes
8. Low coefficient of thermal expansion
9. High heat resistance

Samples Supplied on Request

GENERAL  ELECTRIC

CD46-M1

BUY WAR BONDS

# RAYTHEON VOLTAGE STABILIZERS REGULATE

TO

VARYING  
INPUT  
VOLTAGE

CONSTANT  
OUTPUT  
VOLTAGE  
 $\pm \frac{1}{2}$  OF 1%

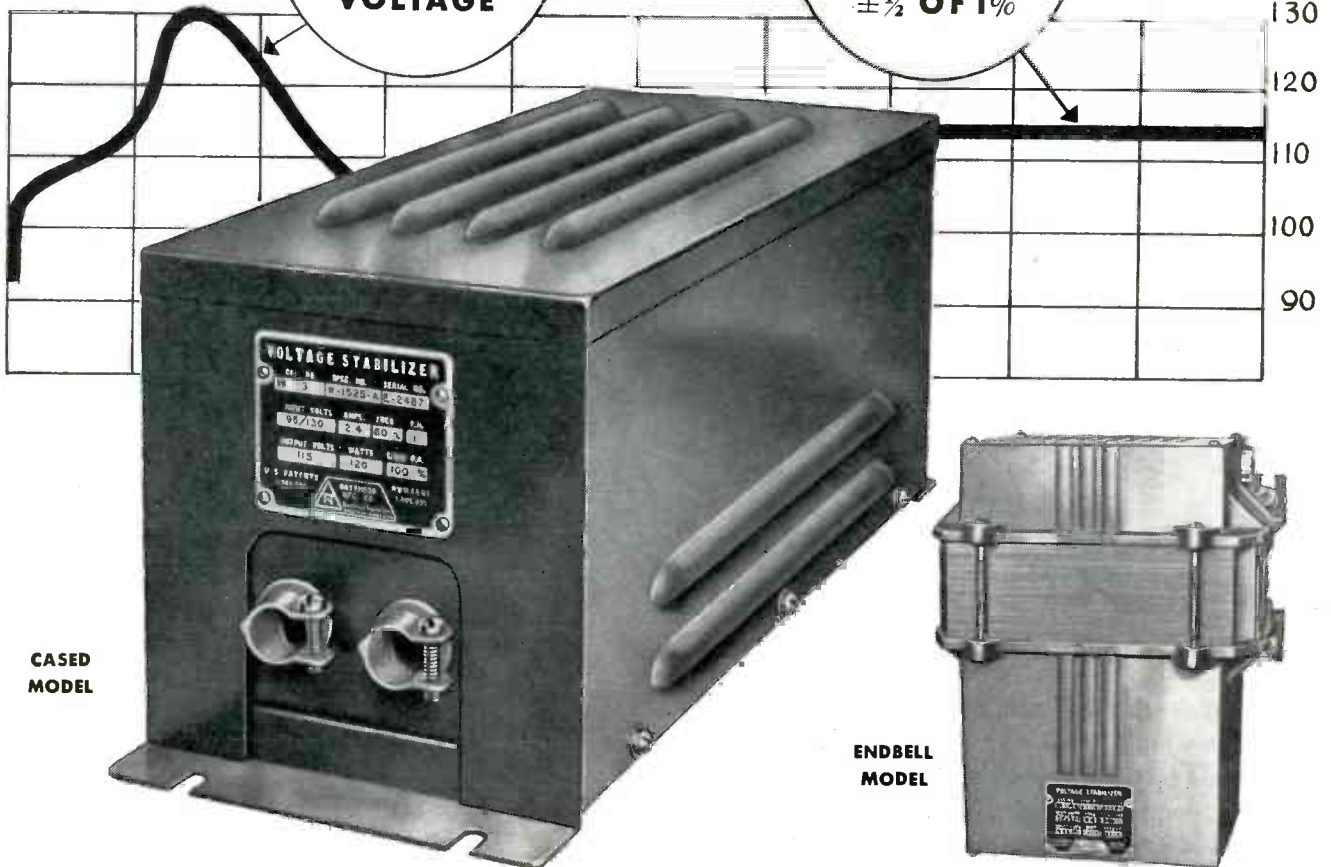

CASED  
MODEL

ENDBELL  
MODEL

Built into new products or installed into equipment already in use, Raytheon Voltage Stabilizers assure more accurate operation of all types of electrical equipment. Note these Raytheon performance features—stabilizes output voltage to  $\pm \frac{1}{2}$  of 1% . . . stabilizes the varying input voltage within 2 cycles . . . stabilizes input voltages from 95 to 130 volts or 190 to 260 volts.

Raytheon Voltage Stabilizers are entirely automatic in operation. They have no moving parts . . . nothing to wear out. Available in three styles, cased, uncased and endbell, to meet most application requirements. Write for bulletin DL 48-537. It gives performance curves, technical data and complete information.

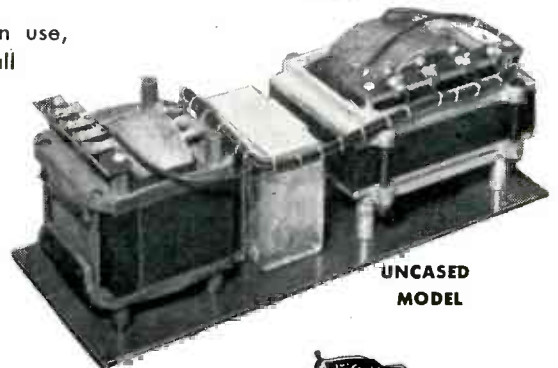

UNCASED  
MODEL

Tune in the Raytheon radio program: "MEET YOUR NAVY," every Saturday night on the Blue Network. Consult your local newspaper  for time and station



## RAYTHEON

MANUFACTURING COMPANY

Electrical Equipment Division

190 WILLOW STREET, WALTHAM, MASS.

Devoted to research and manufacture of complete electronic equipment; receiving, transmitting and hearing aid tubes; transformers; and voltage stabilizers.

The coveted Army-Navy "E," for Excellence in the manufacture of war equipment and tubes, flies over all four Raytheon Plants where over 16,000 men and women are producing for VICTORY.

# NOW...It can be told...

## **RADACOR** **IRON CORES**

The *LARGEST* ever built  
helped the B-29's  
accomplish their tasks

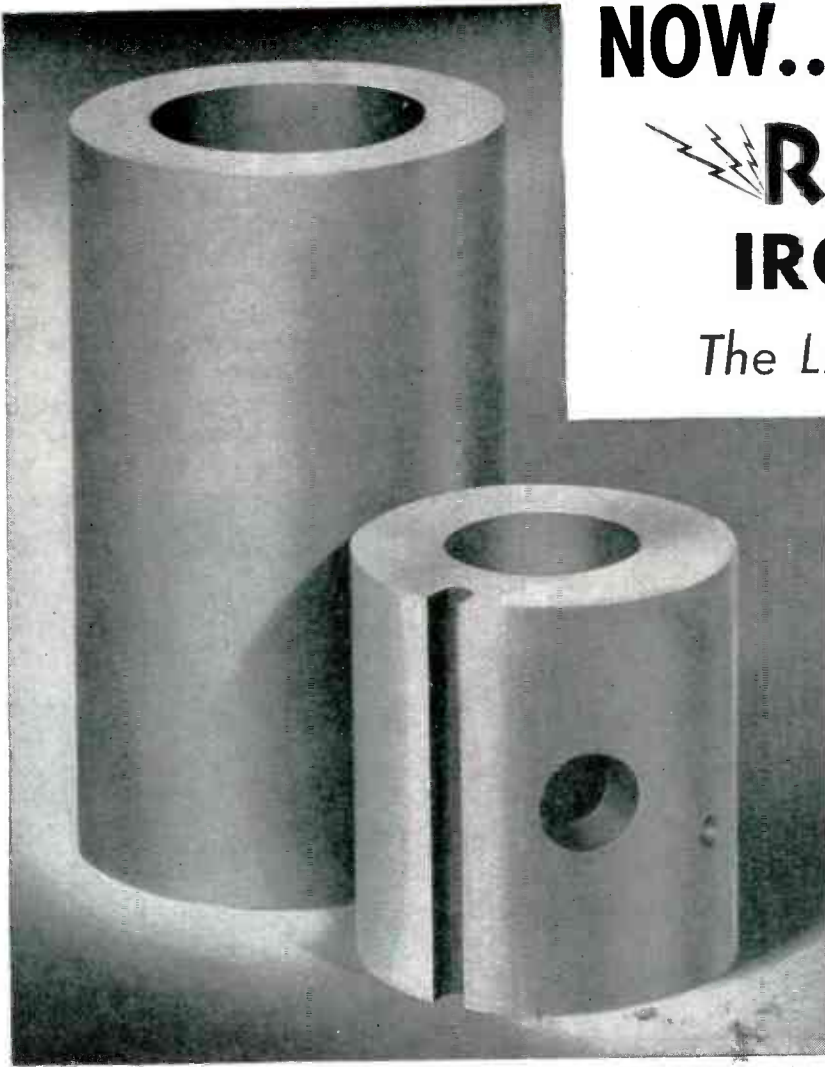

RADACOR Iron Cores—actual size

### **FOR YOUR POSTWAR NEEDS**

High "Q", high permeability (appr. 30) Iron Cores  
for use from 400 KC to 2000 KC. Write us your  
postwar requirements today.

**MICRO-FERROCART**  
**PRODUCTS DIVISION**  
**MAGUIRE INDUSTRIES, INC.**

375 FAIRFIELD AVENUE, STAMFORD, CONN.

Sales Representatives:

Stamford, Conn., Earl S. Patch, Powder Metallurgy Division  
New York, N. Y., 347 Madison Ave.

E. J. Frederick, Railway Sales Division  
Chicago, Ill., 840 No. Michigan Ave.

Ray E. Berg, E. C. Winkenwerder, H. W. KaDell  
Indianapolis, Ind., 108 E. 9th St.

Queisser Bros., Lee Hinds  
Jenkintown, Pa., P. O. Box 246  
D. M. Hilliard

Kansas City, Mo., Broadway at 34th St.  
E. W. McGrade, J. O. Schmitz

Canada, 1041 Des Marchais Blvd., Verdun, Quebec  
W. T. Hawes

RADACOR is the result of exacting wartime demands. When an exceptionally large core with precision milling and extreme electrical and physical tolerances was required for equipment built into B-29's, only RADACOR fulfilled the needs, accomplishing results *never achieved before or since!* GENERAL ELECTRIC COMPANY built the antenna loading units, and orders followed from Stewart-Warner Corporation, Hammarlund Manufacturing Company, Inc., and Sentinel Radio Corporation. We received the largest orders ever placed for one type of Iron Core within a period of a few weeks, totaling almost a half-million dollars.

Such acceptance should merit your consideration when planning the use of Iron Cores as a component of your radio equipment. Our engineering staff of core specialists and our laboratory facilities are available for your specific requirements.

RADACOR Iron Cores are now available in a wide variety of sizes, shapes and ranges, in addition to our complete line of electronic cores.

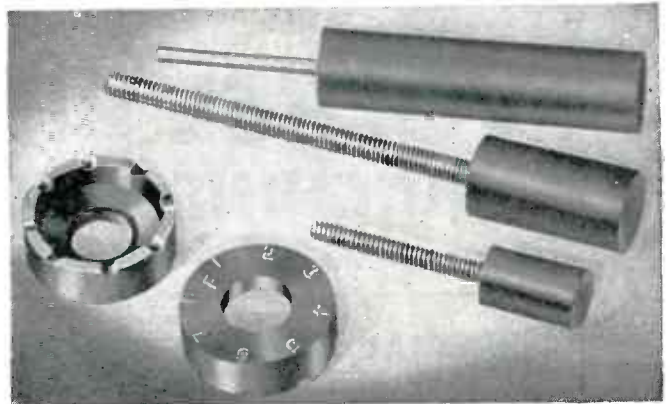

# NEW ANGLE CORRECTION CRYSTAL EDGING MACHINE

CORRECTS "X" AXIS IN MINUTES OF A  
DEGREE TO MEET SIGNAL CORPS SPECIFICATIONS

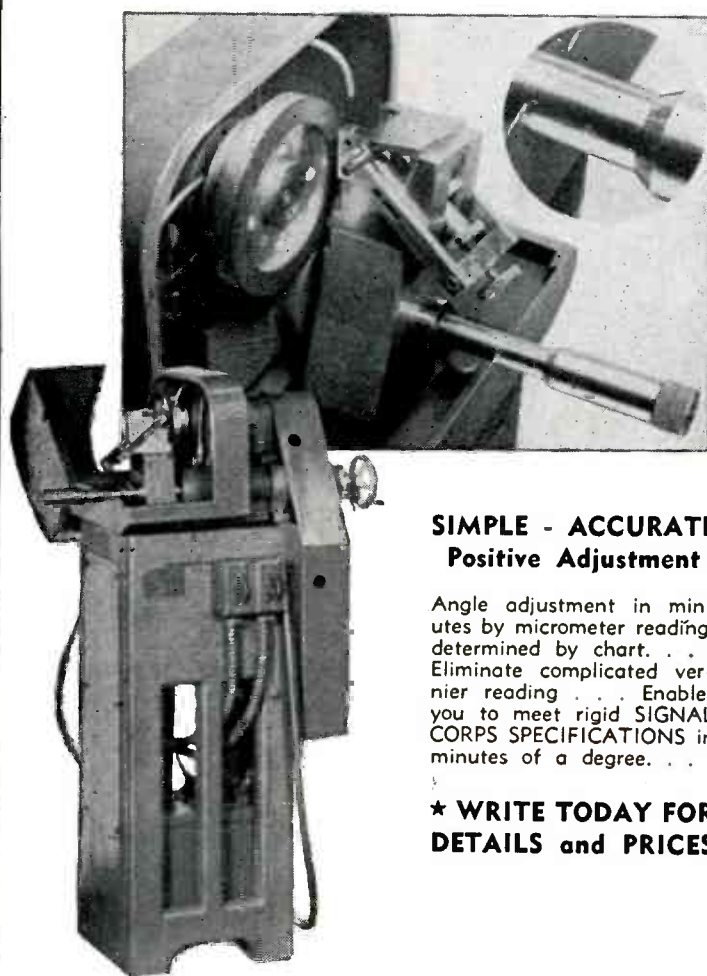

## SIMPLE - ACCURATE Positive Adjustment

Angle adjustment in minutes by micrometer reading, determined by chart. . . . Eliminate complicated vernier reading . . . Enables you to meet rigid SIGNAL CORPS SPECIFICATIONS in minutes of a degree. . . .

★ WRITE TODAY FOR  
DETAILS and PRICES

## VOLKEL BROS. MACHINE WORKS

1943 West Manchester - Los Angeles 44, Calif.

*Designers and Manufacturers of*  
**SPECIAL DEVICES & EQUIPMENT**

ELECTRON MICRO-PHOTOGRAPHY (continued)

the thickness of the deposit varies with the inclination of the surface. Faces of ridges or hollows turned toward the direction from which the metal is sprayed receive the thickest metallic deposit (on the average, about three atoms thick), while faces hidden from the spray point are left uncoated. When the sample is photographed in the electron microscope, the density of the electron beam passed through the sample, and hence the density of



The shadow-cast of a replica of the inner surface of a bearing race shows effects of wear. Scale line represents fifty millionths of an inch

the resulting picture, is determined—in addition to the varying thickness of the sample—by the thickness of the metal deposited on the surface. Because this metallic surface deposit varies in thickness just as the reflected brightness from the same surface illuminated at an oblique angle would vary, the picture gives the appearance of an illuminated three dimensional surface. It is easier to visualize the appearance of the object so photographed, and calculations based on shadow length give an accurate determination of the heights and depths of surface marks as can be seen from the accompanying illustration. Dr. Williams, who developed the technique, calls it "shadow-casting."

A bio-physicist, Dr. Williams has photographed some of the larger organic molecules such as hemocyanin, the oxygen bearer of blood in lower animals, influenza virus, and tobacco mosaic. The latter photograph showed that the mosaic

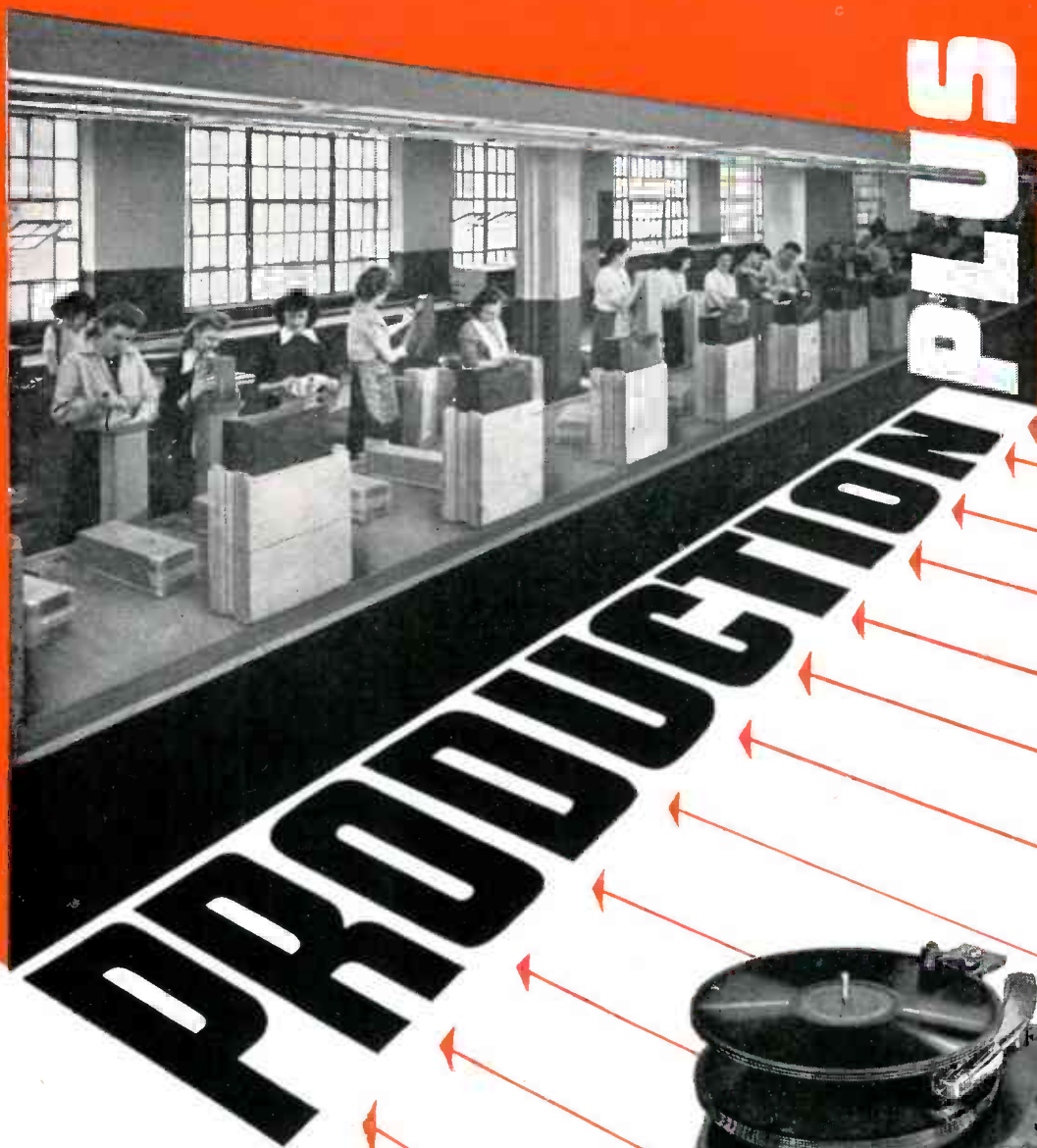

**A**t Detrola Radio, the pouring forth of hundreds of thousands of salable units when the starting gun booms will not be enough. The radio receivers, automatic record changers and other fine-featured products from our plants must blend service and beauty . . . express ingenuity even in details such as engineered packaging for safer transit . . . all to serve America's foremost merchants.

*The distinguished Detrola record changer, better than ever, will be made for selected radio manufacturers and jobbers.*

**DIVISION OF INTERNATIONAL DETROLA CORPORATION • Detroit 9, Michigan**

*Detrola Radio*

# "Sure, My Brakes Can See In The Fog"



\*AFTER VICTORY

FINE PRECISION manufacturing will make possible tomorrow's plans for automobiles equipped with a sound-receiving and projecting device that will control brakes and accelerator. That device will stop a car at a pre-determined distance before it collides with any object ahead.

Precision is our business—has been for 34 years. With the techniques acquired in that period and intensified by war's demands, we have been pre-

cision manufacturing on a low-cost, mass-production basis. V-E Day hasn't slowed us a minute. We're still going full speed ahead for an earlier V-J Day. If you have a wartime or a postwar precision problem, you might find it helpful to discuss it with us.

(Below) Some of the many thousands of our precision parts that help "Keep 'em flying and fighting."



Let's all back the attack—buy EXTRA War Bonds.

## ERICSSON

SCREW MACHINE PRODUCTS CO., INC.

25 LAFAYETTE STREET, BROOKLYN 1, N. Y.

CHASSIS • CABINETS • PANELS • RACKS

*Skill in* **METAL**

PAR-METAL . . . a specialized manufacturing plant employing modern high-speed methods. Nevertheless, Par-Metal products have a definite quality of Craftsmanship—a "handmade" quality born of genuine skill and long experience. Write for Catalogue.



Serving the  
Electronics  
Field  
Exclusively

**PAR-METAL PRODUCTS CORPORATION**

32-62—49th STREET . . . LONG ISLAND CITY, N. Y.

Export Dept.  
10C Varick St., N. Y. C.

# American Beauty

## ELECTRIC SOLDERING IRONS

are sturdily built for the hard usage of industrial service. Have plug type tips and are constructed on the unit system with each vital part, such as heating element, easily removable and replaceable. In 5 sizes, from 50 watts to 550 watts.



### TEMPERATURE REGULATING STAND

This is a thermostatically controlled device for the regulation of the temperature of an electric soldering iron. When placed on and connected to this stand, iron may be maintained at working temperature or through adjustment on bottom of stand at low or warm temperatures.



For further information or descriptive literature, write



107-1

**AMERICAN ELECTRICAL HEATER COMPANY**

**DETROIT 2, MICH., U. S. A.**



*Buy Bonds*  
SPEED VICTORY!

## SNIP IT, SEAL IT, SHIP IT!

*in Traco "All-Size" Bags*

**Tubular Form—1000 Foot Reels**



Make quickly in your own plant TITE-SEAL Cellophane Bags of any size that seal out dust, air, water and moisture-vapor. They protect military supplies from damage in transport or storage.

Acceptable for Methods I and IA, type III packaging . . . available in 3, 4, 6 and 8 inch widths under proper priority . . . 1000 feet to the reel. Saves stocking large quantities of special-sized bags. (Stock Bags also available in above widths.)

"All-Size" Containers and custom made bags can be furnished plain or printed in any widths or lengths desired on special orders of sufficient quantity.

Heavy foil-lined laminated bags or tubes meet every requirement of Methods I, IA and II Military Packaging. LOXTITE Partitions give crash protection to fuses, rations, and delicate or fragile items.

Reasonably prompt shipment can be made on government orders bearing end use. A card will place our technicians at your command.

T. M. Reg. & Patent applied for

# TRAVER CORPORATION

Dept. ET85 • 358-368 West Ontario Street • Chicago 10, Illinois



BOX PARTITION DIVISION  
404 N. Sacramento Blvd., Chicago 12



**BX  
SERIES**

The urgent demand, in peacetime days, by the aircraft and radio industries for a compact, efficient D.C. motor was the challenge that led Pioneer to develop the Pincor BX series. Today Pincor BX motors flow from our plant in a steady stream to the producers of aircraft and radio equipment for the armed services.

Pincor BX motors, in their classification, meet the varied requirements of aircraft and radio manufacturers that demand light weight, compact motors for efficient and dependable application. Pincor BX motors are direct drive, ball bearing, high speed units wound for continuous or intermittent duty. Shunt, series or split series windings are for operation on 12 to 24 volt battery systems currently used and may be easily modified to meet your product demand.

Depend on these rugged Pincor quality-proven motors in the BX series. Send your problem to Pioneer engineers and let them put their years of experience to work for you. Consultation with these men will not obligate you in the least.

DYNAMOTORS • CONVERTERS  
GENERATORS  
POWER PLANTS • GEN-E-MOTORS



**PIONEER GEN-E-MOTOR  
CORPORATION**

5841-49 DICKENS AVENUE CHICAGO 39, ILLINOIS

**BUY MORE BONDS!**

Export Office, 25 Warren Street, New York 7, U.S.A.  
Cable Address: Simontrice, N. Y.

lines are segmented as is bamboo instead of unbroken as heretofore believed.

The development work carried on at the Physics Department of the University of Michigan has been supported by the Evaporated Metal Films Corporation of Ithaca, New York.

• • •

### Three-phase Power From Single-phase Source

By ROBERT W. WOODS

Academic Dean, Union College  
Lincoln, Nebraska

PRODUCTION OF THREE-PHASE power from a single phase source can be accomplished by using a 120-degree lead-phase shifter, a 120-degree lag-phase shifter, and the original unshifted source connected in the circuit shown in Fig. 1.

#### Design Curves and Tables

The shifters can be designed so that there is no attenuation of voltage; or in the notation of the

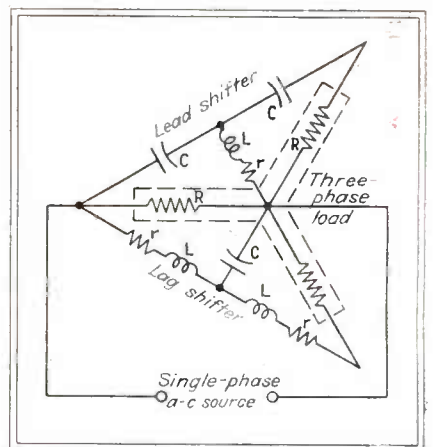

Fig. 1—Connection of lead and lag shifters to obtain power for a three-phase load from a single-phase source

analytic treatment of power phase shifters which appeared in the April 1945 ELECTRONICS

$$\theta = 120^\circ$$

$$\tan \theta = - (3)^{1/2}$$

$$F = 1$$

Because in that notation  $\omega^2 LC = a$ ,  $\omega CR = b$ , and  $\omega Cr = c$ , it follows that equations for the shifters are

The 120-degree curve for the lead shifter

$$a = \left\{ \left[ \frac{\sqrt{b^2 + 1}}{2 + b\sqrt{3}} \right]^2 \right.$$





# LUMARITH\* "WALLS OUT" THE BLACK HAND OF CORROSION

• ELECTRICAL COILS, from the smallest size to the largest, can be effectively protected against electro-chemical corrosion by the use of Lumarith CA (cellulose acetate) insulation. The advantages of this synthetic material in the electrical field are outstanding. Lumarith is resistant to organic decomposition even in the presence of moisture, one of the inherent hazards of many insulation materials. Lumarith CA films and foils have high dielectric strength (2800-3300 volts/mil.) and high softening point. Films and foils are furnished plain or with a special mat finish that aids visibility and prevents slippage. Lumarith is also available in sheets, rods, tubes and molding materials. We will be glad to send you the new reference booklet, "Celanese Synthetics for the Electrical Industry." Write Celanese Plastics Corporation, a division of Celanese Corporation of America, 180 Madison Ave., New York 16, N.Y.

*A Celanese<sup>®</sup>  
Plastic*  
\*Reg. U. S. Pat. Off.

GOSH! THAT PLANT IS ALMOST AS WONDERFUL AS THE NEW *Gothard* PLANT WITH ITS ENLARGED ENGINEERING FACILITIES!

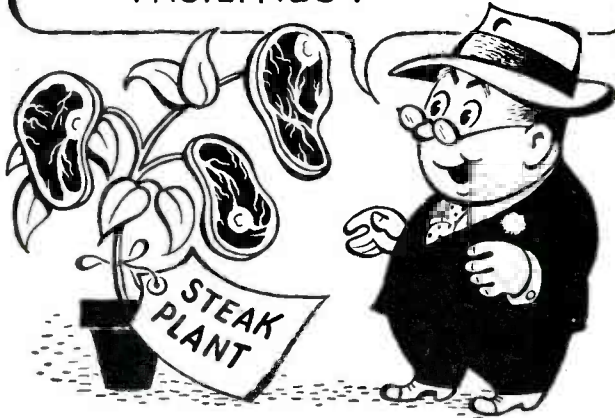

You'll think the Gothard Plant pretty wonderful too—when you want dependable, precision Pilot Light Assemblies quick. Here the finest equipment and talent will answer your needs. Ask for the Gothard Catalog.

**Gothard**  
MANUFACTURING COMPANY  
2114 CLEAR LAKE AVENUE, SPRINGFIELD, ILLINOIS

EXPORT DIVISION: 25 WARREN STREET • NEW-YORK 7, N.Y.

Model No. 1142  
for Neon Lamp  
NE51 and Mazda  
44, 313 and 1815



## SPECIAL DOUBLE FAN UNIT FOR ELECTRONIC APPLICATION

*We make or will design any type YOU need!*

New, ever-changing developments in the field of electronics—particularly for war-time use—have presented an unusual challenge to the genius and skill of ILG engineers. The double fan unit shown, for example, was specially engineered to meet the demands of a manufacturer supplying the U. S. Signal Corps . . . and is typical of the many “made-to-order” jobs produced by ILG. If you need a special fan or one of the many standard ILG fans for cooling and ventilating application, write us for detailed information or call nearby ILG Branch Office (consult classified directory).



ILG ELECTRIC VENTILATING CO., CHICAGO 41, ILL.  
2882 N. Crawford Ave. • Offices in 40 Principal Cities



**VITALIZED VENTILATION**  
AND AIR CONDITIONING

*Make Plans Now...  
for the coming . . .*

## PLASTIC ERA

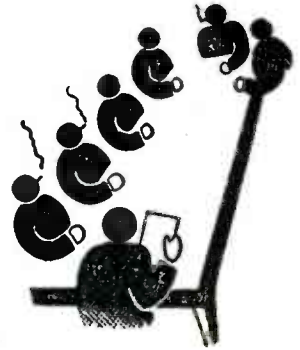

*Consult . . .*  
**ROGAN**

• Here at Rogan, seasoned engineers are ready and willing to assist you in determining your post-war *Plastic* requirements.

Whether your peacetime products are to include electronic equipment, electrical appliances, stoves or what have you, the Rogan Organization will gladly provide cost-free advice on all phases of plastic production.

*Send us  
Your Specifications Today!*

## ROGAN BROTHERS

*Compression Molders and Branders  
of Plastics*

2003 So. Michigan Avenue  
Chicago, Illinois

*Speed up, simplify*

**YOUR SMALL ASSEMBLIES**



Your difficult small assembly jobs can be done quickly and easily. Use Cherry Blind Rivets—the new one-man, easy-to-handle blind fastener. Manufacturers and repairmen everywhere are switching to this improved fastening technique—are making Cherry Blind Rivets standard on their small assembly jobs.

These rivets are upset with a smooth, easy pulling action exerted by small, easy-to-handle Cherry Rivet guns. They can be used on fragile structures,

in soft or brittle materials, in all sheet metals, in crowded or cramped locations. Cherry Rivets are installed by one man from one side of any location, blind or not, without bucking. Though they form a strong, tight fastener, they can be easily and quickly removed with trimmers or a drill.

There are several types, sizes and alloys of Cherry Rivets. Installed rivets are strong and neat. The installed cost of Cherry Rivets is low.

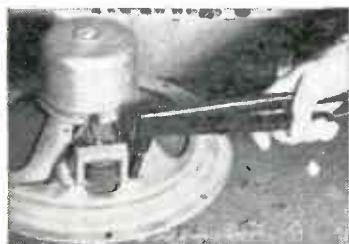

Cherry Riveting transformer to loudspeaker.



Time saved in fastening arm on record changer.

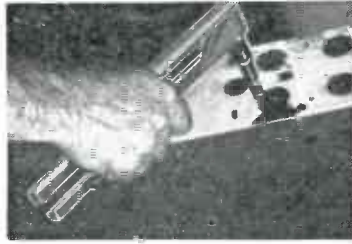

Tube sockets are easily installed; firmly held.

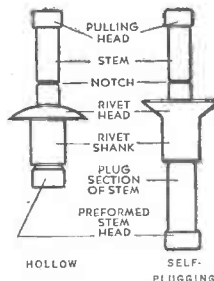

For a quick glance at the many types and uses of Cherry Rivets, write now for illustrated Manual D-45, Department A-120, Cherry Rivet Company, 231 Winston St., Los Angeles 13, California.



CHERRY RIVETS, THEIR MANUFACTURE & APPLICATION ARE COVERED BY U.S. PATENTS ISSUED & PENDING

**Cherry Rivet**  
*Company*  
 LOS ANGELES 13, CALIFORNIA

# A Typical Challenge to ADC

# Engineering!



## Multi-Channel NARROW BANDPASS FILTER UNITS

● Like many of the problems brought to the Audio Development Company, this one involved a definite performance improvement with reductions in size and weight.

From an originally specified maximum weight of 40 oz. for potted one-channel interstage filters, the weight of this ADC five-channel unit was reduced to less than 10 oz. per section, hermetically sealed. Volume was reduced by over 50%.

Electrical performance was improved to provide a midband gain of  $14 \pm 1\frac{1}{2}$  db when the original specifications permitted a loss from 0 to 6 db. In addition, attenuation characteristics were improved to provide approximately 25 db discrimination at  $1/3$  octave with bandpass  $\pm 1\frac{1}{2}$  db over  $\pm 3\%$  of mid-frequency.

These filters are available in single or multi-channel units for frequencies from 200 cps to supersonic and carrier range. Frequencies lower than 200 cps are available with some size increase. Units can also be supplied in combination with high or low pass filters to permit tone channeling on voice circuits, thus allowing several remote control functions to be superimposed on a single voice circuit without interfering in any way with regular service.

We are ready to help with your filter and transformer requirements. Why not consult with us on your specific problem?



**Audio Development Co.**

2833 13th Ave. S., Minneapolis 7, Minn.

THREE-PHASE POWER

(continued)

$$\left[ c + \frac{b - \sqrt{3}}{2(2 + b\sqrt{3})} \right]^2 \Bigg|^{1/2} + \frac{1 + b\sqrt{3}}{2(2 + b\sqrt{3})}$$

The  $F = 1$  curve for the lead shifter

$$a = \left\{ \left[ \frac{b\sqrt{b^2 + 1}}{4} \right]^2 - \left[ c + \frac{1}{2} \right]^2 \right\}^{1/2} + \frac{b^2 + 2}{4}$$

The 120-degree curve for the lag shifter

$$a = [2 + (b + 2c)\sqrt{3} + \sqrt{(4 + 3b)^2 + 16c(b + c)}] / 2$$

The  $F = 1$  curve for the lag shifter

$$a^4 - 4a^3 + a^2(2c^2 + 2bc + b^2 + 4) + a(4c^2 + 4bc + 2b^2) - [c^4 + 2bc^3 + c^2(b^2 + 4) + 4bc]$$

For each value of  $b$ , the first two equations determine a design point for the shifter on an  $a$ - $c$  plane. The

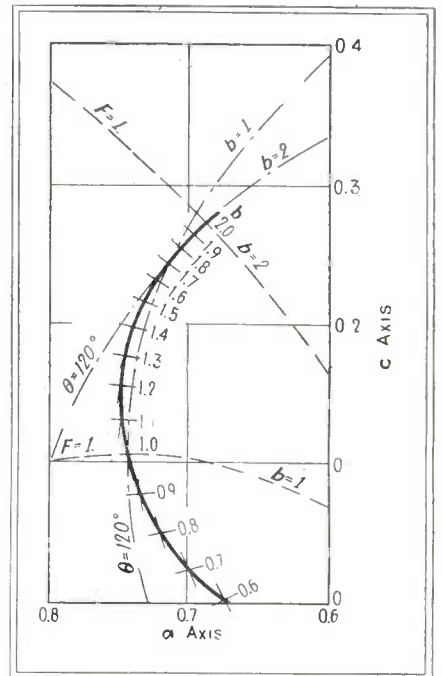

Fig. 2—Design curve for 120-degree lead shifter

locus of these design points gives the design curve of Fig. 2 for the 120-degree, no-attenuation lead shifter. Similarly from the second two equations the design curve of Fig. 3 is obtained.

Because  $a/c = \omega L/r$ ,  $c/b = r/R$ , and  $a/b = \omega L/R$  each design point has associated with it definite values of the above ratios; therefore, if the frequency and load resistance

# MODERNIZE YOUR PRODUCT

## *at Low Cost*

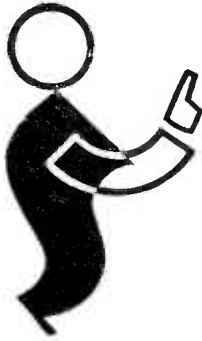

### WITH THESE INEXPENSIVE, HIGHLY ADAPTABLE SWITCHES

#### OTHER STACKPOLE PRODUCTS

Brushes and Contacts  
Carbon Regulator Discs  
Bearings—Pipe  
Anodes and Electrodes  
Packing, Piston and  
Seal Rings  
Welding Carbons, etc.

Up-to-the-minute switches add efficiency to the electrical product, that means greater sales appeal to the ultimate consumer. Stackpole line, slide, and rotary-action switches are highly adaptable to the individual needs of a wide variety of electrical equipment and cost but

little. Eighteen standard units include 3-position types and 1-, 2-, 3-, and 4-pole switches with or without spring return, detent, covers and other optional features. Each can be adapted mechanically or electrically to meet a wide variety of specific requirements.

#### WRITE FOR ELECTRONIC COMPONENTS CATALOG

... for complete details on Stackpole Switches, also Fixed and Variable Resistors, and molded iron cores.

**STACKPOLE CARBON COMPANY, St. Marys, Pa.**

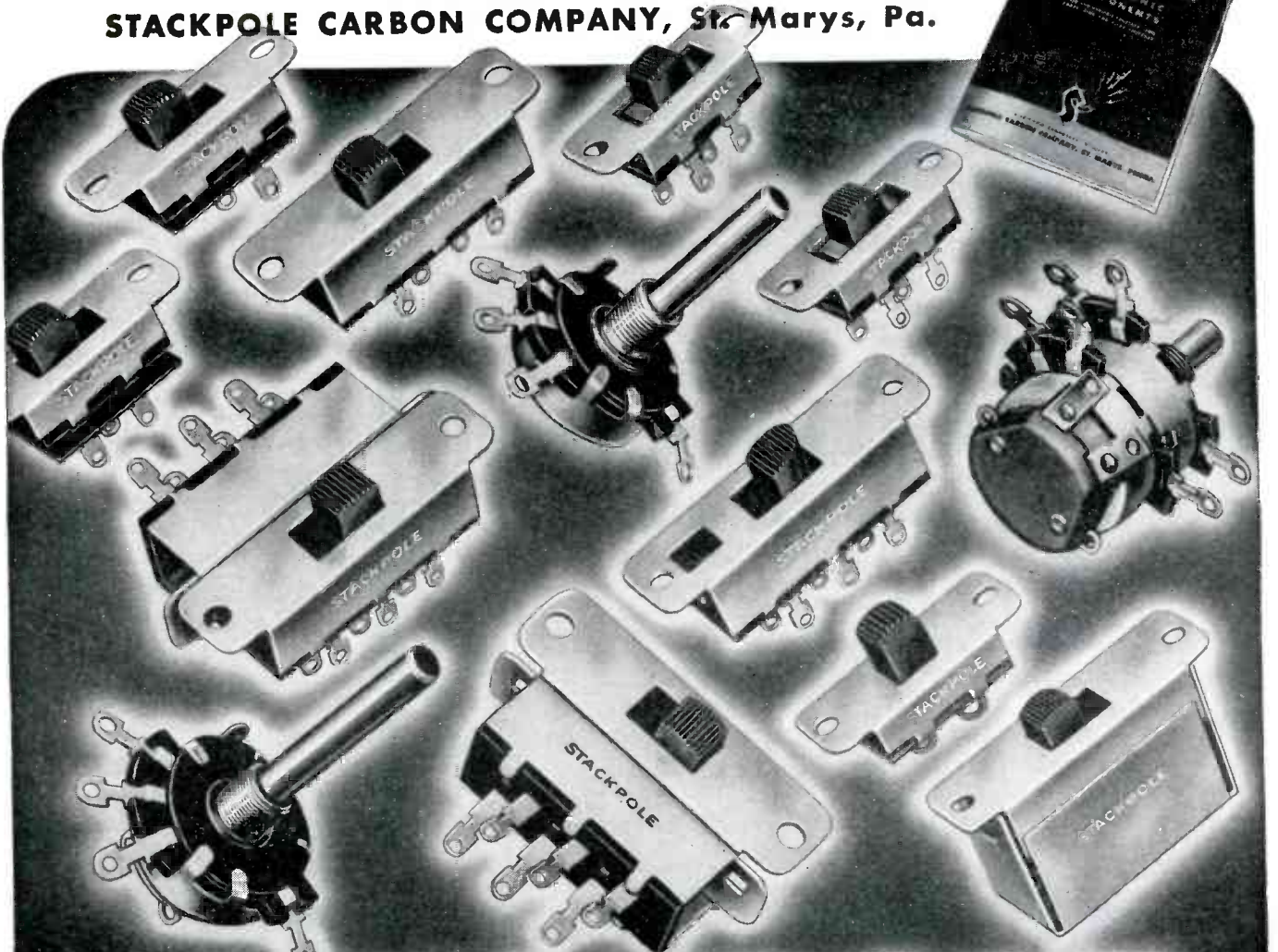

# STACKPOLE

# AGASTAT

ELECTRO-PNEUMATIC RELAY

TIME DELAY

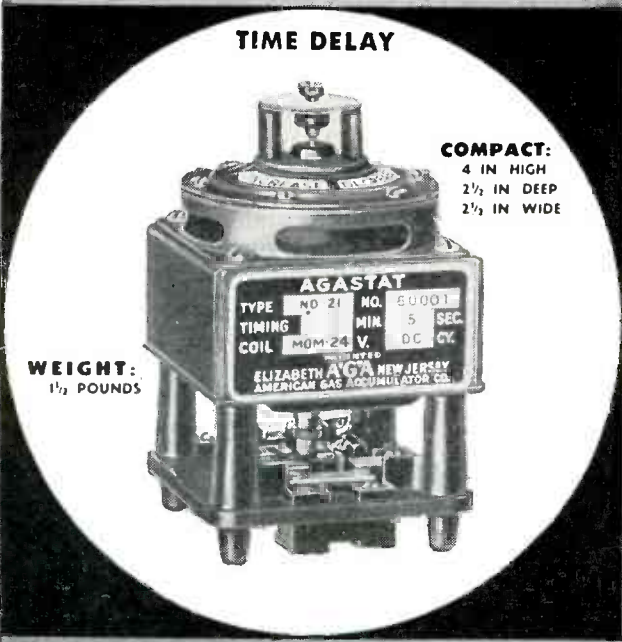

ELIZABETH A'G'A NEW JERSEY  
AMERICAN GAS ACCUMULATOR COMPANY

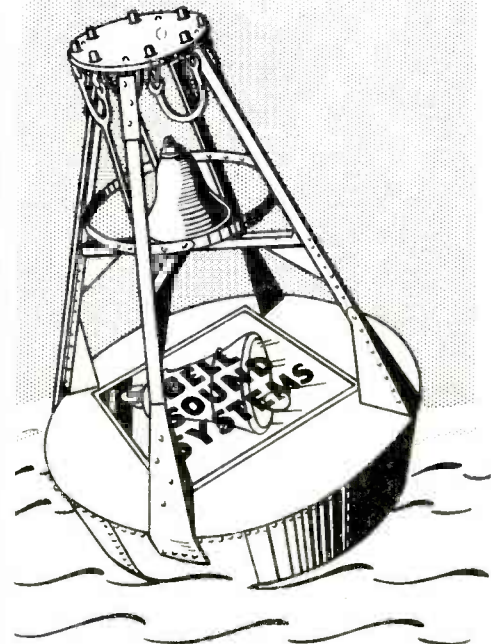

**BUOY UP**  
your post-war  
production with  
**BELL** electronic  
controls or  
assemblies!

# "ALNICO"

## PERMANENT MAGNETS

Specializing in the production of highest quality Alnico Magnets in all grades including new triple strength No. 5.

Production material checked to assure highest uniform quality of product.

Castings made to customer's special order on the basis of sketches or blueprints furnished.

Information and suggestions furnished on request.

# GENERAL MAGNETIC

C O R P O R A T I O N

MANUFACTURERS OF HIGH COERCIVE MAGNETIC ALLOYS

2126 E. Fort Street

Detroit 7, Michigan

A BELL solution to your electronic control or assembly needs may bring you smoother sailing in the post-war picture. Our complete facilities and wide experience warrant your inquiry — and we'll welcome the chance to discuss our capabilities in terms of your specific needs.

BELL PRODUCTS INCLUDE:  
Electronic Sound Devices . . .  
Intercommunicating Systems . . .  
Industrial Voice-Paging and  
Broadcasting Equipment . . . Per-  
manent and Portable Amplifying  
Systems . . . Recording and Disc  
Playing Units . . . Electronic Con-  
trols . . . Operating Sequence Re-  
corders . . . Other Special  
Devices.

**BELL**



**SOUND SYSTEMS, INC.**

1189 Essex Ave., Columbus 3, Ohio

Export Office:

4900 Euclid Ave., Cleveland 3, Ohio

# FF-55!

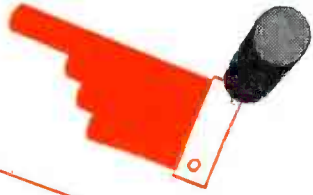

**THE SIGNAL TO REMEMBER**



**K**EEP that designation in mind—FF-55. You will need it when you redesign a lot of your electrical apparatus for genuine postwar efficiency.

It represents the newest and best in laminated electrical insulation—a new product produced with a new fibre base—Glass Cloth—and a recently perfected synthetic resin—Melamine.

While retaining the easy machinability and workability that makes rapid production possible, it offers in combination many qualities that previously could be had separately only in much less adaptable insulating materials.

It has very high strength—tensile, compressive and flexural. It stands up to 440 degrees Fahrenheit for short periods, more heat than any previous laminated grade. It also stands arcing for longer periods.

As there is no cellulose in its composition, it resists fungus growth in the tropics. And moisture absorption is so low, and has so little effect on it, that its stability of dimensions and electrical characteristics is equally unusual.

Other materials with glass fibre bases, and new and useful characteristics are also now available.

You will certainly find use for it. Remember the name, Formica FF-55!

Engineering test data is yours for the asking.

**THE FORMICA INSULATING COMPANY, 4661 SPRING GROVE AVENUE, CINCINNATI 32, OHIO**



Type H-1600

## HERMETICALLY SEALED

**H**ERMETICALLY SEALED Advance Relays maintain their original efficiency under conditions that soon ruin or dangerously impair other types of relays. Dust, moisture, oil or fungus can't reach the precisely adjusted parts. The low atmospheric pressure of high altitudes can't cause failure through arcing or condensation. That these relays are tamper-proof is another advantage. And basically, like all Advance Relays, they have the stamina to resist the severe shock and vibration of battle, as has been so abundantly proved on all war fronts.

### TYPE H-1600

Double pole, single throw. (May be had in single pole, double throw.) Full-floating armature suspension minimizes friction between frame and armature. Pure silver contacts are standard, with palladium or platinum alloys on special order. Wiping contacts insure clean contact surfaces. All steel parts cadmium plated to withstand the 200-hour Salt Spray Test. All brass and bronze parts nickel plated. All laminated phenolic parts moisture-and-fungus-proofed. Coil is wound with highest grade enamel wire and insulated with 100% cellulose acetate with a final vacuum varnish impregnation. Dimensions are: height of case only, 2"; diameter 1-5/8". Mounting screws and solder lug terminals project 5/16" below case.

Any Advance Relay can be furnished in hermetically sealed containers on special order. When you select Advance, you will have relays exactly as you want them. Our engineers are at your service. Write today for full information.



**ADVANCE ELECTRIC & RELAY CO.**  
1260-1262 W. Second Street, Los Angeles 26, Calif.

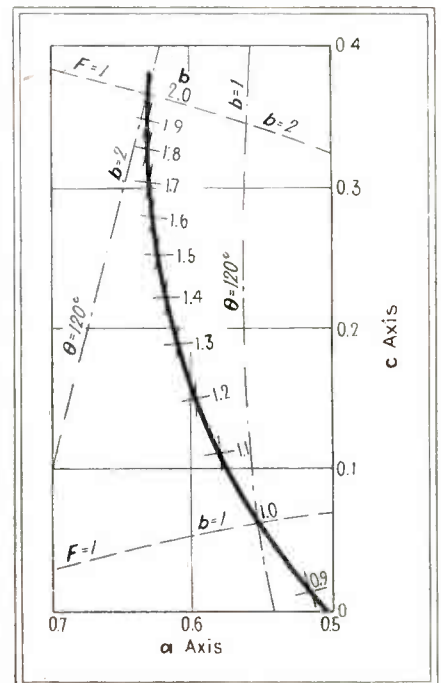

Fig. 3—Design curve for 120-degree lag shifter

*R* be given, the values of *L*, *C*, and *r* can be computed for any selected design point. The transmission efficiency is also fixed at each design point. It may be shown that, for the lead shifter

$$\text{Eff}_{\text{lead}} = 1 / \left[ 1 + bc \frac{c(b^2 + 2) + ab^2 + [(2a - 1) - bc + b^2(a - 1)]^2 + [b(a - 1) - 2c]^2}{(2a - 1) + bc} \right]$$

and for the lag shifter

$$\text{Eff}_{\text{lag}} = 1 / \left\{ 1 + \frac{c}{b} \left[ 1 + b^2 \times \frac{[(b + 2c)(a - 1)^2 + a(2 - a)(b + c) + c(b + c)]^2 + [(b + 2c)(1 - a)]^2}{[a(2 - a)(1 - a) - (b + c)^2(1 - a)]^2} \right] \right\}$$

To show the corresponding values of these various quantities, Table I and Table II have been prepared.

As an application of these tables, let us design a set of shifters for

Table I—Parameters and efficiency of the lead shifter

b	a	c	a/b	a/c	c/b	Eff.
0.6	0.674	0.002	1.122	270.50	0.0042	0.998
0.7	0.702	0.023	1.103	30.50	0.0329	0.980
0.8	0.722	0.049	0.903	14.75	0.0613	0.939
0.9	0.736	0.077	0.819	9.56	0.0856	0.890
1.0	0.745	0.105	0.745	7.10	0.1050	0.828
1.1	0.750	0.130	0.682	5.77	0.1181	0.765
1.2	0.751	0.155	0.626	4.84	0.1291	0.690
1.3	0.748	0.175	0.575	4.27	0.1347	0.620
1.4	0.742	0.197	0.530	3.77	0.1406	0.552
1.5	0.735	0.215	0.490	3.42	0.1434	0.488
1.6	0.725	0.230	0.453	3.15	0.1438	0.433
1.7	0.717	0.242	0.421	2.96	0.1422	0.385
1.8	0.709	0.254	0.394	2.79	0.1410	0.340
1.9	0.700	0.263	0.368	2.66	0.1383	0.301
2.0	0.690	0.272	0.345	2.54	0.1355	0.269





LABORATORY INSTRUMENTS FOR SPEED AND ACCURACY

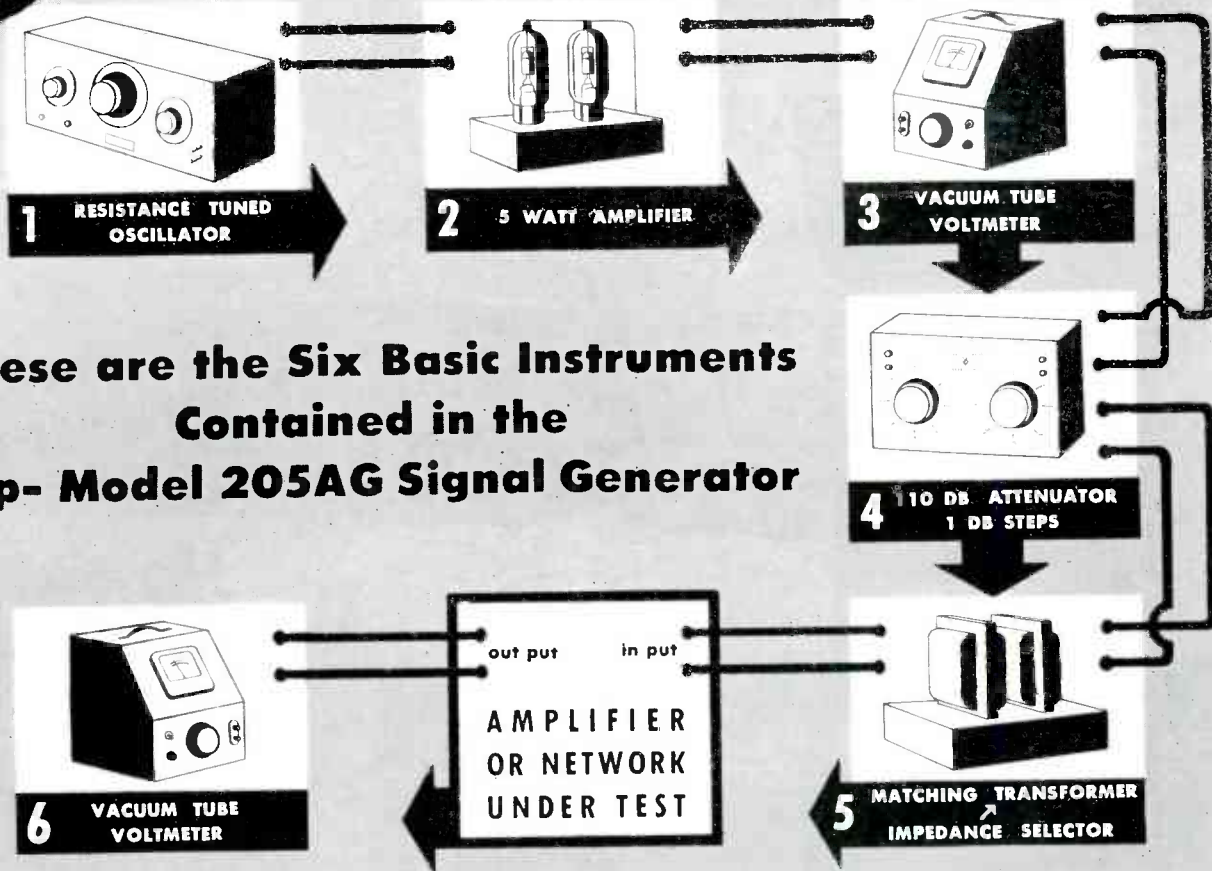

**These are the Six Basic Instruments  
Contained in the  
-hp- Model 205AG Signal Generator**

In order to reduce the task of making gain measurements to the most simple routine possible, *-hp-* engineers assemble all the necessary instruments into a single compact unit. To make amplifier gain measurements, it is necessary only that the operator connect input and output leads to the binding posts provided.

Any desired frequency within the range of 20 to 20,000 cps is made available by the resistance-tuned audio oscillator. Such frequencies are developed at any desired voltage between 150 volts and 50 micro-volts.

There are two vacuum tube voltmeters provided, one to measure input and the second to measure output. The input meter has a range of minus 5 db to plus 49 db, with an input impedance of 5000 ohms.

The output impedance can be instantly changed to the commonly used impedances of 50, 200, 500 and 5000 ohms which is very convenient for matching various types of networks. Furthermore, these impedances are balanced to ground and center tapped. The Model 205AG will supply 5 watts output with less than 1% distortion.

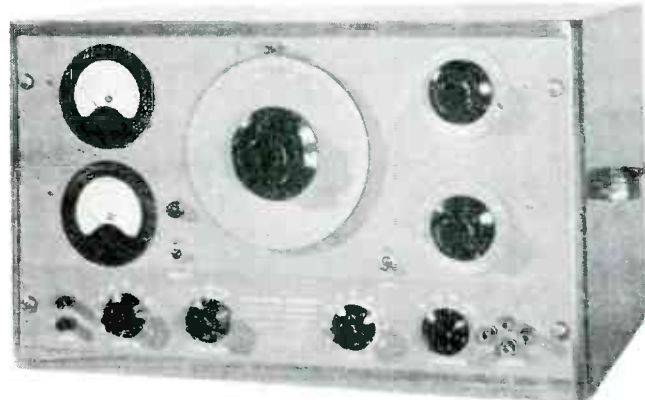

The *-hp-* Model 205AG, providing as it does the six basic instruments in a convenient unit, saves much valuable time in making audio frequency measurements. Its accuracy and versatility, coupled with the extreme ease with which measurements can be accomplished, make it an asset to any electronic laboratory or production line. Ask for more complete information. No obligation, of course.

**HEWLETT-PACKARD COMPANY**

BOX 1046A · STATION A · PALO ALTO, CALIFORNIA



Square Wave Generators  
Attenuators

Audio Frequency Oscillators  
Noise and Distortion Analyzers

Signal Generators  
Wave Analyzers

Vacuum Tube Voltmeters  
Frequency Meters

Electronic Tachometers  
Frequency Standards

**LET US QUOTE ON YOUR**

**SMALL STAMPINGS**

**SPECIAL TERMINALS**

**SOLDERING LUGS**

**PRECISION WASHERS** up to  $\frac{5}{8}$ " O. D.

*Manufactured to Your Specifications*

Large Tool Room Facilities plus 20 Years Experience insure

**HIGH GRADE STAMPINGS**

**QUICK DELIVERIES**

on Medium and Large Quantities

*Let Us Quote on Your Requirements*

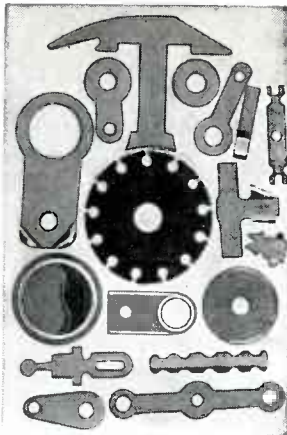

**DIEBEL DIE & MFG. CO.**

3658 N. Lincoln Ave., Chicago 13, Ill. Phone WELLington 4202



**James Knights  
Crystals  
are Made with  
"Bombsight"  
Precision!**

**Let Us Help You with Your Post-War Crystal Problems**

Since 1932, the men of The James Knights Company have consistently developed and improved quartz crystals by finding the one best way of carrying out every production operation. This determination to make every JK Crystal as perfect as possible is your assurance of the utmost in quality and dependable performance.

Our extensive experience with Crystals for every conceivable purpose is available in helping you work out the most effective crystal control applications. Let us know what your problem is and we will get to work on it.

**The JAMES KNIGHTS Co.**

SANDWICH, ILLINOIS

Sixty Miles Southwest of Chicago



*Crystals for the Critical*

**Greater  
Efficiency  
With**

**Electrical  
Papers**

**Made to  
Specifications**

The wide range of functions and requirements of papers for electrical manufacturing purposes call for highly diversified treatments for chemical and physical properties if maximum efficiency in operation and longevity is to be assured. Let our laboratories analyse your requirements.

**FREE BOOK**

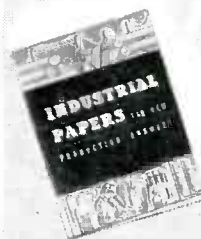

The amazing possibilities of papers in the electrical field, as well as other types of manufacture is told in the book, "Industrial Paper — The New Production Answer." Send for free copy.



REG. U. S. PAT. OFF.

**CENTRAL PAPER COMPANY  
INCORPORATED**

2442 LAKESHORE DRIVE, MUSKEGON, MICH.

*If she can feel it shake...*

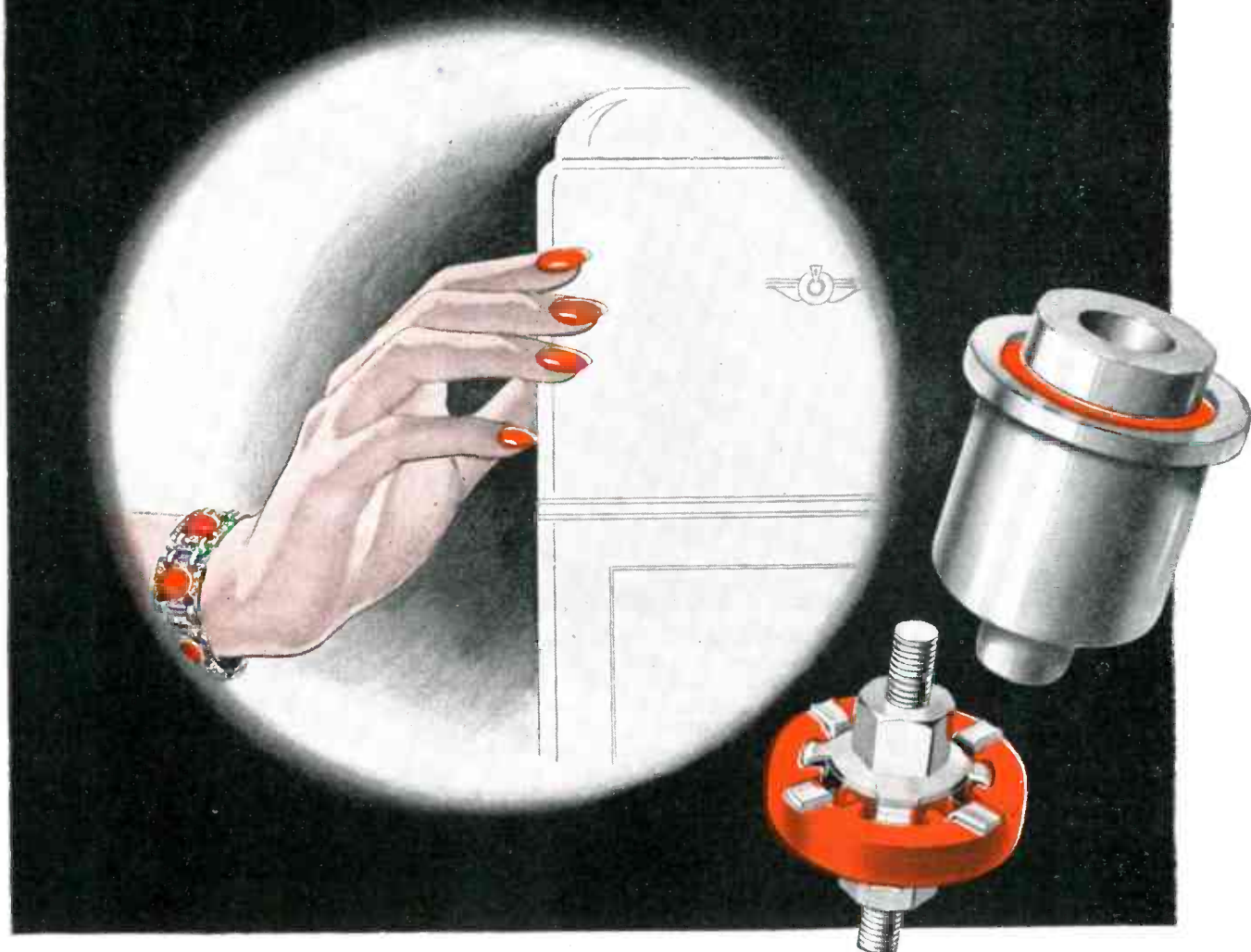

*... you need Silentbloc to damp vibration*

**H**OME equipment should not start and stop with a shudder. Industrial machines must not send nerve-tensing tremors through factory floors. Such vibration impairs smooth operation and invites wear.

In your new products, you can control vibration with engineered precision by using General Silentbloc Rubber Mountings. Patented Silentbloc construction permits almost infinite variation in performance to solve any problem of vibration, noise and shock load. General

engineers will design a Silentbloc mounting to fit your specific need for axial, radial and conical deflections; to vary with operating cycles; to meet any service conditions.

Silentbloc Mountings are made of any metal and any rubber, in sizes to carry loads of ounces to tons. They are simple to incorporate in designs and to install.

Silentbloc Mountings belong in your new-model blueprints. Write for informative booklet. The General Tire & Rubber Co., Dept. 192, Wabash, Ind.

Patented Silentbloc principle of elongating and confining rubber between metal members produces a virtually indestructible adhesion and uniform stress, resulting in precise performance and long life.



*Mechanical Goods Division, Wabash, Ind.*

**THE GENERAL TIRE & RUBBER CO.**

*Makers of America's Top-Quality Tire*

# PORTABLE POWER PROBLEMS

THIS MONTH—BROWN-DUVEL MOISTURE METER

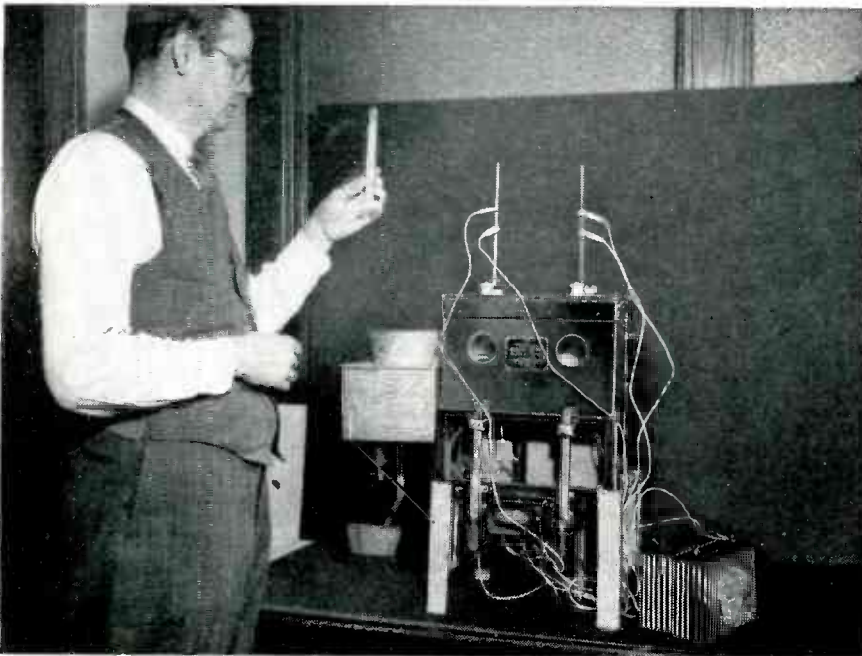

**BURGESS INDUSTRIAL BATTERIES** power the Brown-Duvel Moisture Tester, made by Seed-buro Equipment Co., for the determination of moisture content in grain. And in thousands of similar industrial applications Burgess Batteries are providing the power for electronic test equipment. Purchasing agents and maintenance engineers know they can get a Burgess Battery for every need from their local Burgess distributor. For information on the *complete line* of dry batteries for all test and control instruments, write for the name and address of your nearest Burgess distributor.

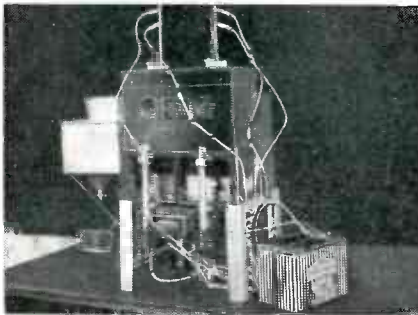

**ELECTRONIC ENGINEERS VOTED** Burgess Industrial Batteries first choice in a recent nationwide survey of dry battery preferences! If you need a special battery for a new instrument or a new application let Burgess engineers solve your problem with the correct battery type. *Burgess Battery Company, Freeport, Illinois*

THE JOB AHEAD—JAPAN!

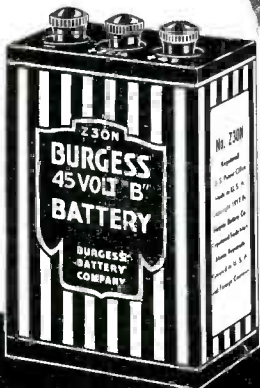

## BURGESS BATTERIES

VOTED FIRST BY ENGINEERS  
IN NATION-WIDE INDUSTRIAL BATTERY SURVEY

Recognized as the MOST COMPLETE LINE of dry batteries

THREE-PHASE POWER

(continued)

60 cycles assuming that  $R = 200$  ohms. There are available three coils: (1)  $L = 0.4$  henry,  $r$ , at 60 cycles, = 20 ohms; (2) and (3)  $L = 0.29$  henry,  $r$ , at 60 cycles, = 13 ohms each. Using the first coil in the lead shifters, we find that

$$\frac{a}{b} = \frac{\omega L}{R} = \frac{377 \times 0.4}{200} = 0.754$$

Interpolating in Table I we obtain the corresponding values

$$\begin{aligned} a &= 0.744 \\ b &= 0.987 \\ c &= 0.101 \end{aligned}$$

whence

$$C = \frac{b}{\omega R} = \frac{0.987}{377 \times 200} = 13.1 \mu f$$

and

$$r = \frac{cR}{b} = \frac{0.101 \times 200}{0.987} = 20.5 \Omega$$

The addition of 0.5 ohms in series with the 20 ohms of the coil satisfies this calculated value of  $r$ .

The second and third coils are to be used for the lag shifter.

$$\frac{a}{b} = \frac{\omega L}{R} = \frac{377 \times 0.295}{200} = 0.5465$$

Table II—Parameters and efficiency of the lag shifter

$b$	$a$	$c$	$a/b$	$a/c$	$c/b$	Eff.
0.9	0.518	0.014	0.575	37.00	0.0156	0.965
1.0	0.556	0.060	0.556	9.38	0.0600	0.878
1.1	0.581	0.110	0.528	5.28	0.1000	0.800
1.2	0.600	0.148	0.500	4.05	0.1241	0.735
1.3	0.611	0.188	0.470	3.25	0.1445	0.680
1.4	0.619	0.220	0.441	2.81	0.1571	0.631
1.5	0.625	0.250	0.416	2.50	0.1666	0.588
1.6	0.629	0.277	0.393	2.27	0.1731	0.548
1.7	0.630	0.301	0.371	2.09	0.1770	0.512
1.8	0.631	0.324	0.351	1.95	0.1800	0.485
1.9	0.631	0.345	0.332	1.83	0.1815	0.462
2.0	0.631	0.365	0.315	1.73	0.1825	0.443

Interpolating in Table II we obtain the corresponding values

$$\begin{aligned} a &= 0.564 \\ b &= 1.033 \\ c &= 0.076 \end{aligned}$$

whence

$$C = \frac{b}{\omega R} = \frac{1.033}{377 \times 200} = 13.72 \mu f$$

and

$$r = \frac{cR}{b} = \frac{0.076 \times 200}{1.033} = 14.7 \Omega$$

The addition of 1.7 ohms in series with the 13 ohms of the coil satisfies this last value.

Without going into details as outlined in the previous article, it may be noted that the voltage rating of the capacitor should be at least 450 volts.

Referring again to the tables we see that the  $\text{Eff}_{\text{lead}} = 0.837$  and



# "The Time Has Come"...

**THE WALRUS SAID**

"to talk of many things"... Of where those essential radio components are coming from — especially those parts you *must* count on, if you are to fill all those postwar orders for home radio sets!

Well, we are ready not only to "talk" but to *act*. Here at G. I. the stage is set. Only a quick shifting of scenes will be required when conversion day comes. Preparations now in progress — to which our major participation in the war effort has contributed in a large way — will find our entire plant expanded and with stepped-up facilities for production, ready to launch into wide scale manufacture of radio components for civilian use.

Yes, we will be ready. So, if you have a problem in radio components, it's high time to discuss it — to look at samples — to make decisions and place commitments. The surest way to beat postwar bottlenecks is to take direct action now, *as we already have*.

• VARIABLE CONDENSERS • ACTUATORS  
• TUNING MECHANISMS • RECORD CHANGERS  
• AND NOW — SPEAKERS

**GENERAL INSTRUMENT CORPORATION**

© 1945, GENERAL INSTRUMENT CORP.



829 NEWARK AVENUE • ELIZABETH 3, N. J.

# ELECTRICITY

FOR ANY JOB  
—ANYWHERE

★ ONAN ELECTRIC GENERATING PLANTS supply reliable, economical electric service for electronics applications as well as for scores of general uses.

Driven by Onan-built, 4-cycle gasoline engines, these power units are of single-unit, compact design and sturdy construction. Suitable for mobile, stationary or emergency service.

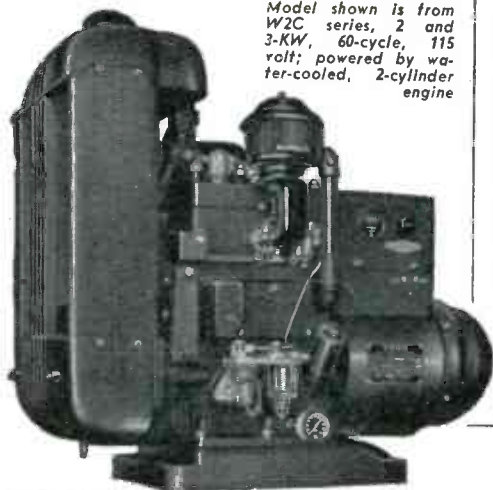

Model shown is from W2C series, 2 and 3-KW, 60-cycle, 115 volt; powered by water-cooled, 2-cylinder engine



"Models range from 350 to 35,000 watts. A.C. types from 115 to 660 volts; 50, 60, 180 cycles, single or three-phase; 400, 500, and 800 cycle, single phase; also special frequencies.

D. C. types range from 6 to 4000 volts.

Dual voltage types available. Write for engineering assistance or detailed literature".

**D. W. ONAN & SONS** -

3267 Royalston Ave.  
Minneapolis 5, Minn.

NUMBER THREE OF A SERIES



DC means SC... Selenium Conversion for magnetic chucks. In a typical case, a Selenium rectifier, assembled on 3 days notice and operating directly from a 3 phase line without transformers, supplied 220 volts DC to magnetic chuck. Less space, lower cost, higher efficiency, better operation proved DC means SC...Selenium Conversion. If you use DC, get the facts on SC!

**SEND FOR  
BULLETIN**

**SELENIUM CORPORATION  
of AMERICA**



1719 WEST PICO BOULEVARD  
LOS ANGELES 15, CALIFORNIA

EXPORT DIVISION: FRAZAR & HANSEN  
301 CLAY STREET, SAN FRANCISCO, CALIFORNIA

IN CANADA: BURLIC LTD., TORONTO 13, ONTARIO, CANADA

LONG LIFE

**The Extra Value  
is in the Extra Life**

Yes, PERMOPIVOTS last lots longer. They multiply the accurate life of precision instruments! It's the precious metals (osmium alloy) tip that does it.

PERMOPIVOTS, wear resistant... non-abrasive... non-corrosive... non-magnetic. PERMOPIVOTS: perfect!

*Write for Literature*

**PERMO INCORPORATED**  
*Manufacturing Metallurgists*  
6427 Ravenswood Ave., Chicago 26

For  
Precision  
Instruments

# 3 REASONS why mica-filled RESINOX 7934

comes through under  
severest operating conditions



## Low Water Absorption

—only 0.030% by weight  
after 24 hours' immersion



## Low Dielectric Constant and Power Factor

Dielectric constant at 1 K.C.  
—4.35 to 4.50

Dielectric constant at 1 M.C.  
—4.20 to 4.50

Power factor at 1 K.C.  
—0.015 to 0.017

Power factor at 1 M.C.  
—0.0080 to 0.0085



## Heat Resistance

Relatively high heat resistance—important where leads are assembled to molded parts by a hot soldering iron.

That rare 3-way combination of Resinox 7934 properties gives *unfailing insulation* to vital medium and high frequency apparatus under the severest operating conditions, especially extreme humidity.

Mica-filled Resinox 7934, based on a recently developed Monsanto phenol formaldehyde resin is available now for molders of all types of war essentialities. Molders have found that Resinox 7934 offers ease and economy in molding, far superior to ordinary mica-filled phenolics... also that it is suitable for both transfer and compression molding.

For complete information and technical counsel on the use of this product, write, wire or phone: MONSANTO CHEMICAL COMPANY, Plastics Division, Springfield 2, Massachusetts.

The broad and versatile family of Monsanto Plastics includes: Lustron\* polystyrenes • Cerex\* heat resistant thermoplastics • Vinyl acetals • Nitron\* cellulose nitrates • Fibestos\* cellulose acetates • Resinox\* phenolics • Thalid\* for impression molding • Resimene\* melamines • Forms in which they are supplied include: Sheets • Rods • Tubes • Molding Compounds • Industrial Resins • Coating Compounds Vupak\* rigid, transparent packaging materials.  
\* Reg. U. S. Pat. Off.



# SMALL But Stand-outs!



Manross tops the field in sensitive springs for instruments, gauges, relays, etc. Materials to suit your conditions of use—processed to give accurate, long-lived service. Sound design—carefully controlled production in any quantity.

## MANROSS *hair springs*

**F. N. MANROSS & SONS**  
 DIVISION OF ASSOCIATED SPRING CORPORATION  
 BRISTOL, CONNECTICUT

$\text{Eff}_{\text{lag}} = 0.852$ . The overall efficiency of power conversion from single phase to three phase can be shown to be

$$\text{Eff}_{\text{total}} = \frac{3}{1 + (1/\text{Eff}_{\text{total}}) + (1/\text{Eff}_{\text{lag}})}$$

which in this case gives  $\text{Eff}_{\text{total}} = 89$  percent.

The required current-carrying capacity of the coils can be calculated from these efficiencies. In this case the coils would carry approximately 0.75 amperes.

It should be recalled that this analysis assumes a resistive, linear load. Possibly the most frequent application of three phase at 60 cycles is to motors where the load has a reactive component. For optimum design in this application, it is necessary to compensate each of the field windings for its inductive component at full load. The effect of the shifter on the pull-in and pull-out torques as compared with operation directly from a three-phase line awaits experimentation. That there is some effect is to be expected because the starting load differs from the running load in both effective resistance and reactance.

This method of producing three-phase power from a single-phase source can be used at frequencies other than 60 cycles; it is stable in operation under line-voltage variations or amplitude modulation of the input voltage.



### FILAMENT STRESS



Stresses that occur in the turns of a filament are removed by applying a gas flame to the filament while being rotated in this machine at the Dobbs Ferry plant of North American Philips



# KYLE TRANSFORMERS



Engineered to take advantage of latest trends in radio design

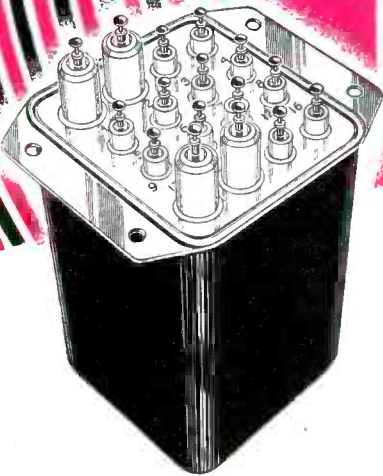

New products, new ways of doing things will require transformers engineered to take advantage of the latest trends in electronic equipment design and manufacture . . . Kyle Transformers built to meet exact specifications. ¶ Kyle engineers have constantly met and solved ever changing problems involving application of transformers to the wartime fields of radio communication, radar detection and electronic controls. ¶ Kyle Transformers are hermetically sealed to function perfectly under conditions they are designed to meet . . . whether for use in cold, temperate, or tropical climates. ¶ This alert, young-thinking organization is at your service. It is backed up by long experience in the manufacture of electric power distribution equipment. Kyle engineering, manufacturing, and plant facilities are top notch. It will pay you to send your transformer specifications to Kyle.

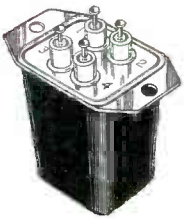

KYLE



CORPORATION

SOUTH MILWAUKEE, WISCONSIN

BACK THE INVASION — BUY MORE BONDS NOW!

from "Midget" to **"GIANT"**...  
 ... the extensive line of  
**DIALCO PILOT LIGHT ASSEMBLIES**  
 cover all physical and electrical requirements

From space-saving midget Pilot Lights to giant Marine Panel Assemblies, Dialco units offer unlimited variations in size, shape, functional design, and electrical characteristics. Fixed or variable intensity of light; smooth, faceted, or torpedo-type jewels; wide choice of colors and platings; Mazda or Neon Lamps—countless combinations of these factors are readily available for the production of Pilot Lights for Aircraft, Marine, Electrical, Electronic, Radio, and Industrial Apparatus. Samples from our standard line are available upon request. If your problem is unusual, our Engineering Dept. stands ready to design a Pilot Light to meet your particular requirements. For immediate assistance, write us about your needs today.

**PLUS LAMPS:**  
 To help speed production, we offer Pilot Lights complete with the required General Electric or Westinghouse Lamps

WRITE FOR CATALOGUE

**DIAL LIGHT CO.** of America, Inc.  
 900 BROADWAY • NEW YORK 3, N. Y.  
 Telephone: ALgonquin 4-5180-1-2-3

BACK THE INVASION — BUY MORE BONDS NOW!

for **BATTLE** or

**COMPETITION**

**Y**ou can always depend on Winco Rotary Electrical Equipment to do its job in a way that will help build and maintain your record for outstanding service and dependability. Our engineers are at your service. Consult them when you need—

- ★ Built-in and Shell Type Motors
- ★ Adjustable Speed Motors
- ★ Synchronous Motors
- ★ Rotary Electrical Equipment for Aviation
- ★ Dynamotors and Inverters
- ★ Motor Generator Sets
- ★ Railroad Car Lighting Generators

**WINCO ROTARY**  
**ELECTRICAL EQUIPMENT**  
 WINCHARGER CORPORATION      IOWA CITY, IOWA

VITREOUS ENAMEL PRECISION WOUND **RESISTORS**  
**TELEPHONE SWITCH KEYS & JACKS**

TELEPHONE COMMUNICATIONS and CABLE ASSEMBLIES  
 Weather-and-Fungus-Proofed

Backed by 20 years of winding experience. 75 Winding Machines

**PRESTO**  
 Electronic Components

**PRESTO ELECTRIC COMPANY**  
 Manufacturers of Signaling Devices  
 UNION CITY, NEW JERSEY



## **PIONEER MANUFACTURER of FM BROADCASTING EQUIPMENT LEADS AGAIN!!**

REL announces it is prepared to furnish to the FM broadcast stations now on the air, power converting devices applicable to transmitters of any manufacture, which will furnish one or three kilowatts output power at any frequency in the new band (88 - 106 megacycles). This device enables the station to transmit simultaneously, in addition to its old frequency, the new frequency during the important interim period of operation.

This device requires no additional monitoring of the audio program as one monitor controlling point takes care of both frequencies.

This device furnishes you with a relatively inexpensive method of operation during the transition period.

Consult us immediately for prompt delivery of your order, pending lifting of present restrictions.

PIONEER MANUFACTURERS OF FM TRANSMITTERS EMPLOYING ARMSTRONG PHASE SHIFT MODULATION

**RADIO ENGINEERING LABS., INC.**  
*Long Island City, N.Y.*

# NEWS OF THE INDUSTRY

**Broadcast prosperity; JETEC personnel; survey notes on servicemen; fundamental research; railroad radio; meeting scheduled; Washington, FCC, business news**

## FCC Places F-M in 88-106 Megacycle Band

ON JUNE 27, 1945 the Federal Communications Commission issued report 83095 announcing their adoption of alternative No. 3, with certain modifications, for the much-discussed band between 42 and 108 megacycles. The unexpectedly early decision was made because of the WPB announcement that the manufacture of a-m, f-m, and television transmitters and receivers might commence at an earlier date than was originally indicated. The channel allocations are as follows:

Freq. Band	Final Proposed Allocation
42—44 mc	Nongovernment fixed and mobile
44—50 mc	Television—Channel No. 1
50—54 mc	Amateur
54—60 mc	Television—Channel No. 2
60—66 mc	Television—Channel No. 3
66—72 mc	Television—Channel No. 4
72—76 mc	Nongovernment fixed and mobile
76—82 mc	Television—Channel No. 5
82—88 mc	Television—Channel No. 6
88—92 mc	Noncommercial educational f-m
92—106 mc	F-m
106—108 mc	Facsimile

This allocation is essentially the allocation proposed as alternative No. 3 of the earlier report, except that the nongovernment fixed and mobile services have been moved from 104-108 mc to 72-76 mc, and f-m and television have been adjusted accordingly. The advantage of this change is that it makes possible immediately the use of all 13 television channels below 300 mc. Under alternative No. 3, as originally proposed, the entire 6-mc television channel between 72 and 78 mc could not be used until the aviation markers centering on 75 mc were moved.

The nongovernment fixed and mobile services are not under the same disability. They can use the entire band between 72 and 76 mc at once with the exception of approximately 0.5 mc in the vicinity of 75 mc to protect the aviation markers. This shift of the nongovernment fixed and mobile services from 104-108 mc to 72-76 mc also results in a possible increase in the number of channels available to these services, since a 40-kc channel is adequate in

the 72-76 mc portion of the spectrum, whereas a 50-kc channel was proposed in the 104-108 mc region.

The FCC will move with all possible speed to revise present regulations and standards of good engineering practice for the operation of f-m, television and facsimile broadcasting in the new allocations. As soon as these revised rules and standards are adopted by the Commission, the industry will have all the information it needs from a regulatory standpoint to proceed with the planning and design of new receiving sets and transmitters.

When manpower and materials again become available and conditions permit the resumption of normal licensing practices, the Commission will make an appropriate announcement and will provide a period of not less than 60 days for the filing and processing of new applications prior to taking any action on the 420 f-m and 119 television applications now in its pending files. In the meantime, the Commission's staff will go through these ap-

plications and call for whatever further information may be required due to the change in bands. In the majority of cases there will be no material difference in the distances to the 50 microvolt per meter contour in either band.

Chairman Paul A. Porter recommended that f-m receiver manufacturers build sets to cover the entire band from 88 to 108 mc. This will make possible the expansion of f-m in the event facsimile is ultimately located in the 400-mc region and vacates the band 106-108 mc. Also, he took the opportunity to point out if the public is to enjoy the full capabilities of f-m, manufacturers must build receivers which will reject undesired signals and noise up to one half the strength of the desired program.

### Alternatives

The other two alternatives for the disputed 44-108 mc region, along with a tabulation of all remaining allocations for that region of the radio spectrum above 25 mc, are given in the July 1945 issue of *ELECTRONICS*.

In the FCC hearings there was unanimity that alternative No. 2 (68-86 mc for f-m) was completely unfeasible.

The primary objection to alternative No. 1 was the amount of sky-wave interference which will result among f-m stations if f-m is placed in the 50-68 mc region. For



Building fund activities of IRE bring together in meeting these familiar figures of the industry—around the table, in rotation: Keith Henney, *ELECTRONICS*; Melville Eastham, General Radio; T. M. Odarenko, Federal Telephone & Radio; R. R. Batcher, Caldwell-Clements; Roger Wise, Sylvania; D. E. Noble, Galvin; W. R. G. Baker, GE; L. C. F. Horle, consultant; Ben Gross, Gross Distributors; Walter C. Evans, Westinghouse; Haraden Pratt, Mackay; L. G. Pacent, Pacent Engineering; (and against the wall) E. W. Ritter, Corning Glass; J. C. Trostle and A. L. Aderton, building fund campaign directors; H. C. Forbes, Colonial Radio; D. J. Phelps, General Instrument; L. F. Miles, Maxon; E. J. Staubitz, Blaw-Knox; and David Kahn, Radio & Television



### UHF HARMONIC FREQUENCY GENERATOR

PROVIDES output voltages which are multiples of 10 or 40 megacycles with CRYSTAL-CONTROLLED accuracy.

RECOMMENDED FOR: the calibration of receivers, wavemeters, or using internal beat detector for calibration of oscillators and signal generators.

WRITE FOR FULL DETAILS



*Lavoie Laboratories*  
RADIO ENGINEERS AND MANUFACTURERS  
MORGANVILLE, N. J.

## An Open Letter on your War or Post-War UHF Problems . . .

This letter is your invitation to consult with us on your present or reconversion problems in the UHF field.

Your immediate plans may consist simply of ideas on which you require technical advice - or you may need help in re-design or ways and means to lower production costs.

Regardless of your particular requirements, our specialized knowledge of UHF, plus a plant especially equipped for UHF production, should be invaluable in accomplishing your objective quickly, accurately and economically.

There is no cost or obligation involved in talking it over. Your inquiries will have our prompt and careful attention.

Very truly yours,

LAVOIE LABORATORIES

### UHF PRECISION FREQUENCY METER

Completely portable Accuracy 0.1%  
Battery or AC-Operated

Models available from 100 to 1500 megacycles with 2 to 1 frequency coverage on each model. Available only on high priority.



# OHIO

## MOTORS for ELECTRONIC APPLICATIONS

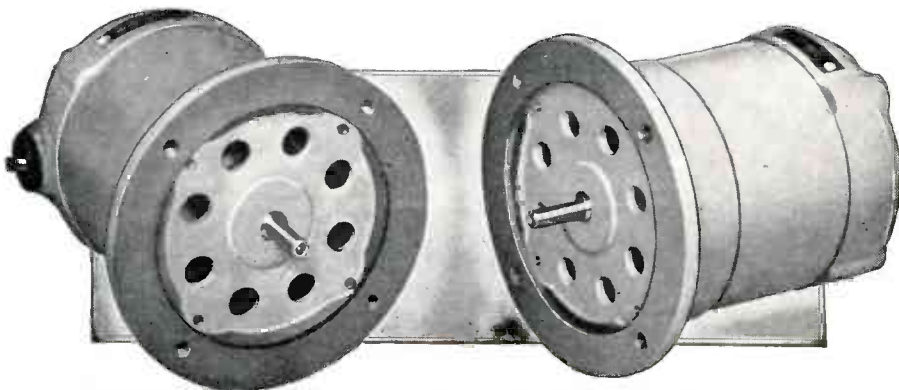

1/30 HP—115 V.—60 Cy.—A. C.—1 Ph. 1725 RPM. C. C. Flange Mounting. Ball Bearing.

Cut shows one of many types and sizes of Ohio Motors designed for driving Electronic Devices.

### RANGE

1/100 to 2 HP.—A.C.

1/100 to 1 HP.—D.C.

1/100 to 1/4 HP.—A.C. Synchronous.

1 to 100 oz. ft. A.C. Torque.

Shell type motors for built-in applications to 4 HP.—D.C. and to 7 1/2 HP.—A.C.

All usual voltages and cycles.

*What is your problem?*

## THE OHIO ELECTRIC MANUFACTURING CO.

5908 Maurice Avenue Cleveland 4, Ohio

example, interference among 50-kw f-m stations at 58 mc from sporadic E transmissions alone, assuming a 10:1 ratio of desired to undesired signal and full occupancy of the channel, might be expected for 140 to 480 hours per year at the 50-microvolt contour from stations 900 and 1000 miles distant, respectively. At 84 mc, in contrast, interference under these conditions would be anticipated for only 6.5 to 25.5 hours per year. It should be noted that the 140-480 hours per year of anticipated interference would not be spread out evenly throughout the entire year, but would be concentrated in two or three summer months.

In addition, interference from  $F_2$  transmission at 53 mc may be anticipated for as many as 470 hours per sunspot cycle, concentrated in a period of three years in the case of a sunspot cycle the same as the last one, or interference may exist for as much as 2,650 hours per sunspot cycle if the next sunspot cycle is as severe as the highest on record. These figures assume only two stations on a channel; more than two would double or treble the number of hours during which  $F_2$  interference would be expected at 53 mc.

### *Practical Conditions*

These interference figures mean, for example, that a listener tuned to a station which is carrying the program of his choice may suddenly find either that the program to which he has been listening is being interfered with by a station hundreds or even thousands of miles away, or else that control of his receiver has been seized altogether by a distant station, completely obliterating the desired programs despite anything he does to the tuning controls.

It has been argued that the bulk of the interference anticipated will be found in outlying rural areas which rely upon low-intensity signals for their radio reception and that if these areas be excluded, f-m service will be more than 99-percent perfect. The Commission, however, is under a statutory duty to make available to *all* the people of the United States an efficient nationwide radio service. The Commission's duty is not fulfilled if its

Would you settle for

32 years service

from a portable testing instrument?

Typical Portable Instrument of the NP Line with sturdy walnut case.

Steel Six Line, another group of portable testing instruments slightly smaller in size with a sturdy steel case... also available.



A 1912 Roller-Smith instrument returned for repairs after 32 years of service in Sioux City, Iowa.

Sounds fantastic, but it's more than possible. The excellent features of today's Roller-Smith portable testing instruments make it possible to expect better performance than the 1912 Roller-Smith instrument that has seen continuous service for 32 years.

Features of today's NP line of portable testing instruments include: Thoroughly aged beryllium-copper springs, polished sapphire bearings, pre-aged permanent magnets, complete magnetic shielding, dust and moisture

proof enclosure, sturdy walnut case. These are assurance of long life and accurate performance of NP portable instruments for general testing purposes. The Roller-Smith NP line is available in direct current—milliammeters, ammeters and voltmeters; in alternating current—ammeters, voltmeters, wattmeters, power factor meters and frequency meters.

For full information on Roller-Smith instruments, write for Catalog 4340 to Dept. EL-2.



Sales Representatives  
In all Principal Cities

**ROLLER-SMITH** BETHLEHEM, PENNA.

Canadian Plant: ROLLER-SMITH MARSLAND, LTD., Kitchener, Ontario

STANDARD AND PRECISION ELECTRICAL INSTRUMENTS • AIRCRAFT INSTRUMENTS • SWITCHGEAR • AIR AND OIL CIRCUIT BREAKERS • ROTARY SWITCHES • RELAYS • PRECISION BALANCES

# BUS-BAR

Formed in  
2 PLANES to  
.001" ACCURACY

WITH  
**DI-ACRO**

**BENDER**  
No. 2



ONE-HALF  
ACTUAL  
SIZE

A heavy Copper Bus-Bar for panel board and terminal assemblies is illustrated, accurately duplicated in two planes with angles formed both flat and edgewise, across the material horizontally and vertically.

DI-ACRO Bender No. 2 has a forming radius up to 6" and capacity of 1/2" cold rolled solid steel bar or equivalent

Send for Catalog  
"DIE-LESS  
DUPLICATING"

showing all models of DI-ACRO Benders, Shears and Brakes, and many examples of parts formed by

"DIE-LESS DUPLICATING"



← Pronounced "DIE-ACK-RO"



**O'NEIL-IRWIN MFG. CO.**

321 Eighth Ave. So.,  
Minneapolis 15, Minn.

For your present and  
post war electronic  
instrumentation.

Actual

Size



— SERIES VW —

A new 15 ma., 1.5 volt sub-miniature vacuum tube with —peak inverse potential up to several thousand volts— Grid current less than 10-14 amperes — grid resistance approximately 10<sup>16</sup> ohms.

Available as . . .

Electrometers  
Pentodes  
Tetrodes  
Triodes  
Diodes

. . . or to your  
specifications.

. . . and hand in hand with this tube development a new Victoreen Hi-Meg vacuum sealed resistor. Values from 1 megohm to 1,000,000 megohms.

1,000,000 Megohms

Actual size

Meeting the needs of fine instrumentation with unusual stability.

Write for our technical brochure on tubes and resistors.

**THE VICTOREEN INSTRUMENT CO.**  
5806 HOUGH AVENUE  
CLEVELAND 3, OHIO

## D.C. to A.C. CONVERTERS

An Inverted Rotary Converter is a rotating electrical machine for converting direct to alternating current.

Janette was one of the first manufacturers to design, build and develop rotary converters for use with numerous A.C. devices; especially those using electronic tubes. Since their inception they have established a world wide record for reliable, efficient, quiet, trouble-free operation under the most adverse conditions. Two types are built: one for standard and special commercial uses; the other for marine service.

Ask for Bulletin 13-25 for COMMERCIAL Type Converters  
or Bulletin 13-27 for the MARINE Type

**Janette**

Janette Manufacturing Co. 556 W. Monroe St. Chicago 6, Ill.

UP  
TO 3.2  
K.V.A.

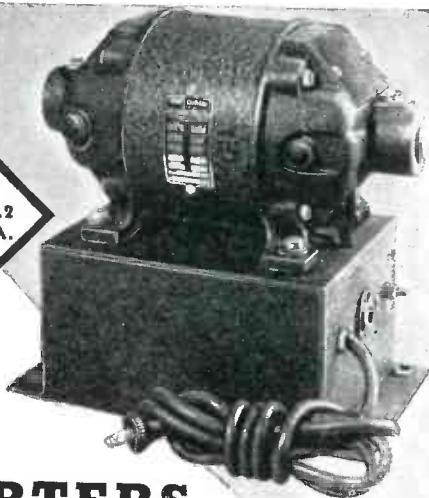



# LOOK to BEST

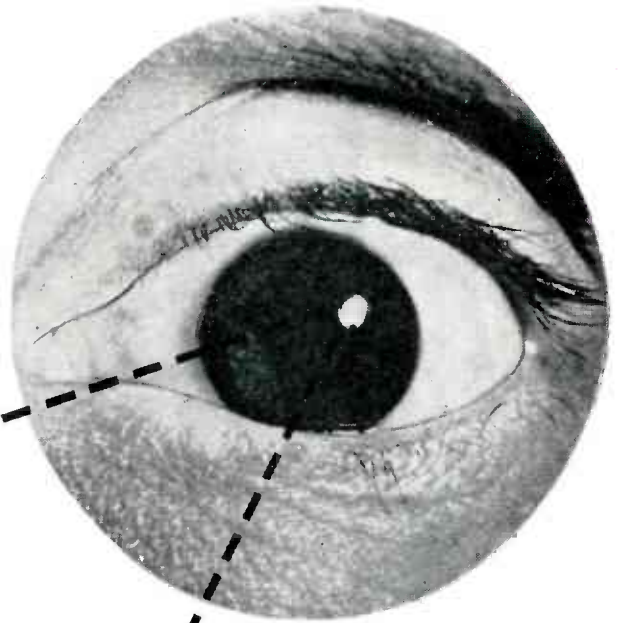

Thirty new BEST speakers, incorporating every advance in speaker design, achieve higher efficiency at lower cost through the use of ALNICO 5 permanent magnets.

## for quantity deliveries of "controlled performance" LOUD SPEAKERS

A dependable source of supply for quality loud speakers need not be a problem. We at BEST are aware of the continuing urgency of keeping your production lines rolling. Our facilities are complete for the manufacture of precision coils, transformers and loud speakers, which have flowed from this plant in increasing quantity for almost a quarter of a century. Whether your problem be one of design or quantity production, rely on BEST to deliver the goods on time!

*We invite your inquiry*



SINCE 1922

**BEST MANUFACTURING CO., INC.**

*Electronic and Sound Reproducing Equipment*

1200 GROVE STREET • IRVINGTON 11, N. J.

Export Division: 25 Warren St., New York 17, N. Y. Cable Address: Simonrice, N. Y. All Codes

# "FRAHM" Frequency Meters

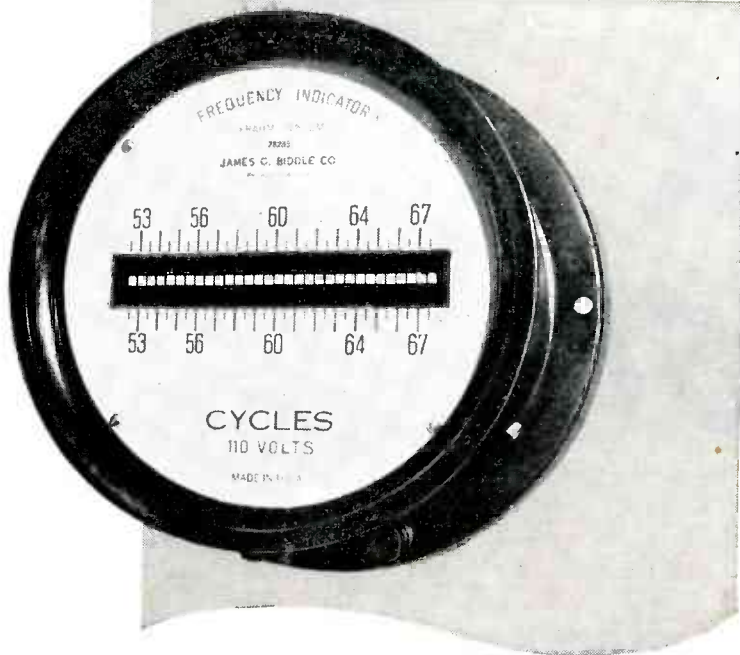

What are your Frequency Measuring Requirements  
...25...60...100...400.....1400 cps?

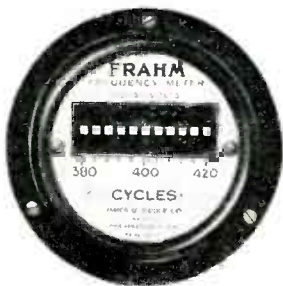

Frahm Frequency Meters in switchboard, miniature and portable types are regularly available for ranges between 15 and 500 cycles per second.

To meet special requirements, our laboratory has designed and built instruments for measuring frequencies as high as 1400 cycles. Such, we find, is possible by means of the same simple and direct resonant reed principle, usually requiring less than 0.1 volt-ampere power input, and without recourse to intermediate frequency conversion equipment. We believe that even higher frequencies are possible.

We invite correspondence regarding any frequency measurement problem in the audio and sub-audio range. For its solution we proffer our instruments, our services and facilities. In our 30 years of association with the resonant reed principle as applied to the measurement of frequency, we have been instrumental in the solution of a surprising variety of problems.

*Write for Bulletin 1770-E now in preparation.*

*This instrument was developed for direct indication of frequencies in the lower audio range and for simultaneous direct indication of harmonic components. Called a Harmonic Analyzer, it has unusual electrical characteristics and a wide range, with a total of 288 reeds.*

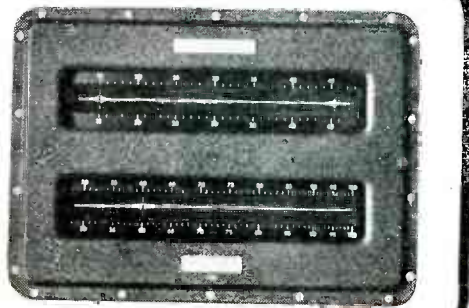

**JAMES G. BIDDLE CO.** 1211-13 ARCH STREET  
PHILADELPHIA 7, PA.

provision for f-m service is such as to make it impossible for rural areas to enjoy satisfactory service.

Various objections to assigning the higher frequencies to f-m have been raised. For example, it has been alleged that tropospheric interference may be worse in the vicinity of 100 mc than in the 50-mc region. The Commission in its report of May 25, 1945, specifically pointed out that there would be some difference in tropospheric propagation, but this difference would be only slight and that tropospheric interference at the higher frequencies could be eliminated by slightly increasing the geographical separation between stations.

## Cost

The point has also been made that equipment for use in the vicinity of 100 mc will cost more than equipment for use in the vicinity of 50 mc. This will no doubt be true at least temporarily, but competition should reduce the differential substantially, and the Commission believes the benefit to the public resulting from an interference-free service will more than outweigh the slight increase in initial cost for service in the 100-mc region.

Much emphasis was placed at one time on the presumed hardship which would result to the approximately 400,000 persons who had purchased f-m receivers before the war. Most of these receivers are combination a-m/f-m and the a-m part of the receiver will continue to be used. There is now substantial



At the right a photographer takes directly from the cathode-ray screen a record of the characteristic curve of an electron tube being tested at the left. Equipment, developed by engineers of Sylvania Electric Products Inc., speeds to designers in a matter of minutes vital information which would require many man-hours if done by conventional methods

# Quality, Economy and Durability are Assured

*with Capacitors  
by Magnavox*

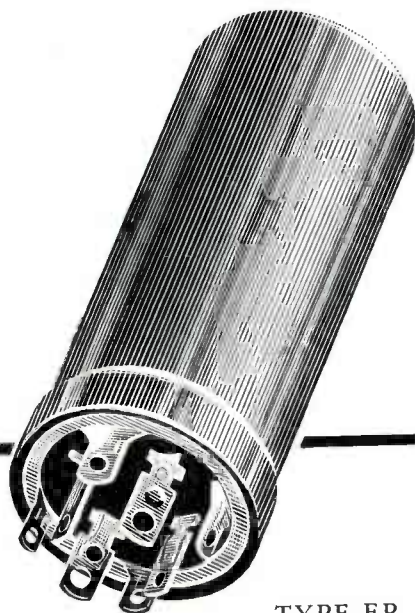

TYPE FP

*Improved processing technique insures fine performance, long life, economy, speedy delivery*

**F**OR 34 years Magnavox has served the radio industry—supplying the finest quality components and perfecting advanced engineering techniques.

★★ Engaged now in supplying demands of the armed services, Magnavox will again serve the radio industry in the traditional manner after conversion.

★★ Specializing in FP (fabricated plate) Electrolytic Capacitors, Magnavox is able to effect a full standardization program with all the advantages that it provides. Our technical department is available for individual consultation regarding capacitors for special applications.

★★ Thirty-four years experience, plus the additional advantages of new Magnavox developments and the superb equipment in our modern six-acre plant, is your guarantee of the best in quality components now and in reconverted civilian production.

The MAGNAVOX Company, Components Division



★ ★ ★ ★ Fort Wayne 4, Indiana

# Magnavox

THE OLDEST NAME IN RADIO

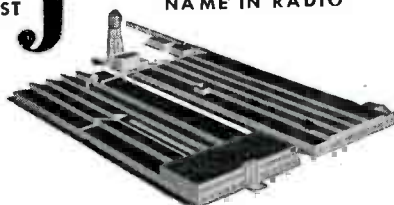

SPEAKERS · CAPACITORS · SOLENOIDS · ELECTRONIC EQUIPMENT

**SENDING**

**FAXOGRAM**  
*World's Fastest  
 and most accurate  
 Communications System*

After V-J Day you will, with Finch equipment, be able to send completely accurate facsimiles of any written or printed message, including drawings and photographs, as far as radio will reach — at a speed of about 48 square inches (up to 1500 words) per minute. Over 80 Finch patents protect and are developing this "Instant Courier" for your service.

**RECEIVING**

Finch Telecommunications, Inc., Passaic, N. J. • N. Y. Office: 10 E. 40th St.

Self-Synchronizing **finch facsimile**

**DINION**

**PIONEERS  
 IN OIL-FILLED  
 TRANSFORMERS  
 For RADIO and RADAR**

**DINION COIL COMPANY, Inc.**  
 CALEDONIA, N. Y.



**VERSATILITY . . .  
 special parts  
 in any metal**

The most efficient functioning of a special part in your product often depends upon the metal used. Our engineers will be glad to help you at no obligation on your part. We are equipped to cold-forged special parts in any metal, and in a wide variety of finishes. And costs for cold-forged parts are usually less.



*This Decimal Equivalents wall chart is accurate to four places and signalled in three colors. Yours at no cost or obligation. Just send us your name, title and address.*

See our Catalog in Sweet's File for Product Designers

**JOHN HASSALL  
 INC.**

*Specialists in Cold-Forging  
 Since 1850*

**150 Clay Street  
 Brooklyn 22, N. Y.**





## Yes...the "Lab" work is *Complete!*

OUR post-war plans, policies and perfected line of Eastern sound equipment have long ago passed the stage of draft-board design and laboratory tests! We're "in the groove"—ready to go! Based on our many years of experience, the new Eastern equipment incorporates the many

wartime techniques which we have been building into *quality* units for Uncle Sam.

For details and information please fill out and mail the Coupon today. Eastern Amplifier Corporation, 794 East 140th Street, New York 54, New York.

# EASTERN AMPLIFIERS

*This is Your Ticket*

for complete information on our post-war line and the details of our proposition.

EASTERN AMPLIFIER CORPORATION, Dept. 8-F  
794 East 140th St., New York 54, N. Y.

We are  JOBBERS,  DEALERS,  A SERVICE ORGANIZATION,  SOUND SPECIALISTS. We're definitely interested in your post-war line, your policy, your proposition. Mail us complete information, without obligation.

COMPANY NAME .....

ADDRESS .....

CITY .....ZONE.....STATE.....

INDIVIDUAL .....TITLE.....

## THE NEW **BRUSH** DEVELOPMENT

TO CHECK  
SURFACE ROUGHNESS  
of 100 to 3000 Microinches

# Announcing

## THE NEW BRUSH ROUGH-FINISH MEASURING PICKUP AND DRIVE HEAD

A perfect complement for the Brush Surface Analyzer is the new Rough-Finish Measuring Head. Developed to meet the growing need for the checking of rougher surface finishes and waviness, it accurately measures irregularities from 100 to 3,000 microinches, peak to valley.

This new Pickup (Model BL-101) and Drive Head (Model BL-102), when used with the Brush Surface Analyzer, extend its usefulness and range of measurement from 1 to 3,000 microinches.

*Write today for descriptive literature.*



**THE BRUSH DEVELOPMENT COMPANY**

3423 PERKINS AVENUE

CLEVELAND 14, OHIO

agreement that the 42-50 mc band for which these receivers were made is wholly inadequate and unsuited to f-m reception. Accordingly, no one today argues that postwar f-m should be degraded to the point necessary to accommodate these receivers. However, interim operation in the present band from 42 to 44 mc is being provided until such time as equipment for the higher frequencies is freely available to the public and until owners of existing receivers have had equal opportunity to adapt or convert them to the new band. In this connection, a converter was demonstrated to the Commission which would make existing f-m receivers capable of tuning to the higher frequencies and which should retail for approximately \$10.00.

### **Bretton Woods & Good Business**

HEADED BY Ralph E. Flanders of Jones and Lamson Machine Co., a so-called Business and Industry Committee for Bretton Woods is supporting those agreements as a basis for postwar prosperity through international trade. One of a special series of reports issued by the committee deals with the effect of Bretton Woods on the electronics industry. Copies can be obtained from the committee headquarters in the Roosevelt Hotel, New York 17, N. Y.

### **Electronics in a Saxophone Factory**

VACUUM TUBE APPLICATIONS involving a number of different factory operations at the plant of C. G. Conn Ltd. were recently described by director of engineering research E. L. Kent at a Cedar Rapids, Iowa, section meeting of IRE.

Summarized, the uses included: a smoke alarm control system which used a phototube to reduce the bias on a blocking oscillator and allow a tone to be heard which rose in pitch as the smoke intensified; a dynamic balancing unit for gyro rotors which utilized an electronic wattmeter with a reference signal from a phototube applied to one section while the vibration signal entered the other input terminals; a device for measuring speed of

# So much insulation, so little weight...

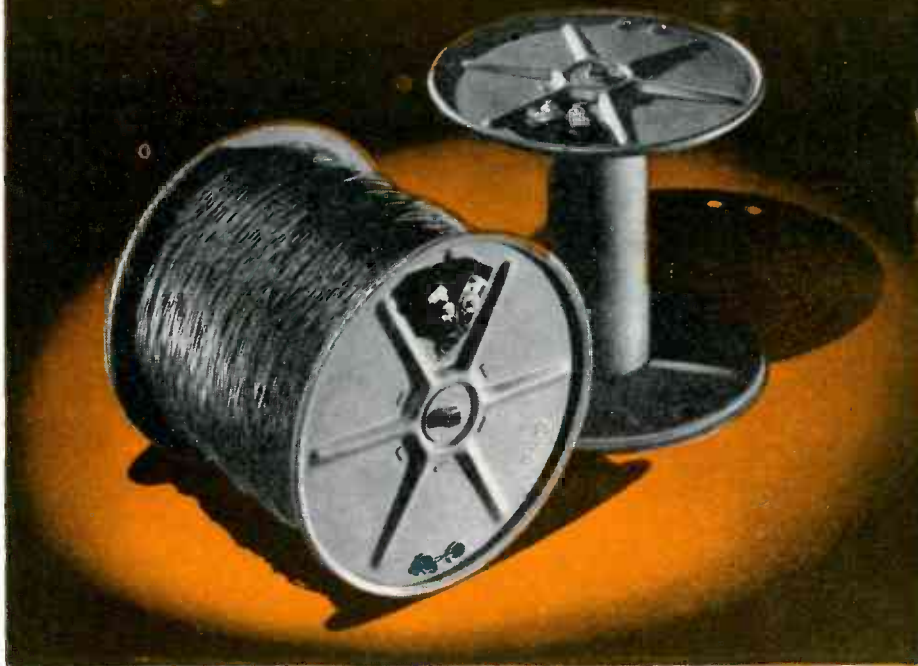

Assault wire insulated with

## Du Pont POLYTHENE

Assault wire is the low-voltage telephone wire laid down by the most advanced troops. Insulated with Du Pont polythene, this wire exceeds the U. S. Army Signal Corps specifications: *weight*—not more than 30 lbs. to the mile; *loss in electrical transmission*—not exceeding 6 decibels per mile after 48 hours' immersion in water. Polythene-insulated wire has a talking range of 10.7 miles when dry, and 6.8 miles when wet. These talking ranges are greater than those accomplished with any insulating material previously used.

**POLYTHENE**, the versatile Du Pont plastic, has greatly extended the usefulness of assault wire used by the Army. That's because polythene gives better insulation with less weight than any other flexible insulating material.

Polythene's specific gravity is 0.92. Even more important are polythene's excellent electrical properties—plus the fact that these properties change very little over the temperature range from -50°F. to 220°F.

Other important properties of polythene are these: Flexibility and toughness over a wide range of temperatures, low water-absorption (less than 0.0005%); chemical inertness; ease of extrusion at an economical rate of speed.

All polythene now being produced is under WPB allocation. Small quantities for experimental purposes can be obtained upon proper application. Address E. I. du Pont de Nemours & Co. (Inc.), Plastics Department, Arlington, N. J.

Buy—and Hold—WAR BONDS



BETTER THINGS FOR BETTER LIVING  
...THROUGH CHEMISTRY

### IT IS CARRIED



... by G. I. Talking range of assault wire is about 7 miles. Polythene's light weight enables a soldier easily to carry a mile of it on his back.



... or Jeep. When terrain permits, spools of assault wire are sometimes carried on a jeep, unwound as jeep advances.

### IT IS LAID FROM

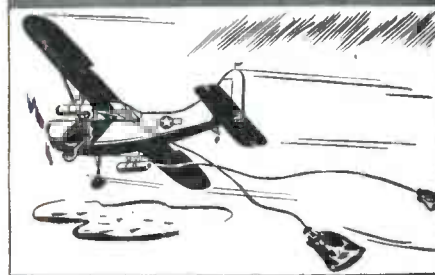

... Plane. This new wire is used in the laying of telephone wire from a plane, traveling at about 110 miles per hour.



... or Bazooka. To carry the wire over streams, swamps, other hazards, even the bazooka has been used to lay assault wire.

FOR PLASTICS..

CONSULT DU PONT

# FM

## SIGNAL GENERATOR



### TYPE 150-A series

Developed to assist engineers in designing FM equipment—RECEIVERS, TRANSMITTERS, AMPLIFIERS, LIMITERS AND COMPONENTS

Type 150 A—Frequency 41-50 mc. and 1-10 mc.  
Type 151 A—Frequency 30-40 mc. and 1-9 mc.  
Type 152 A—Frequency 20-28 mc. and 0.05-5 mc.  
Type 154 A—Frequency 27-39 mc. and 1-7 mc.  
Frequency and Amplitude Modulation available separately or simultaneously.



### BOONTON RADIO

BOONTON, N. J.

*Corporation*



DESIGNERS AND MANUFACTURERS OF THE "Q" METER . . . QX-CHECKER . . . FREQUENCY MODULATED SIGNAL GENERATOR . . . BEAT FREQUENCY GENERATOR . . . AND OTHER DIRECT READING TEST INSTRUMENTS

MADE BY *Engineers* FOR *Engineers*

# CORWICO

# WIRES

*Now in daily use "over there"*

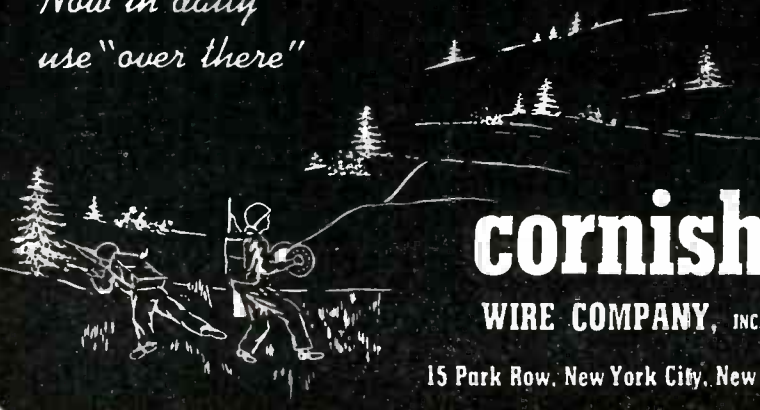

## cornish

WIRE COMPANY, INC.

15 Park Row, New York City, New York

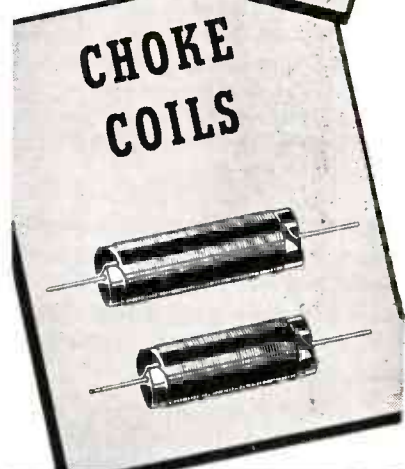
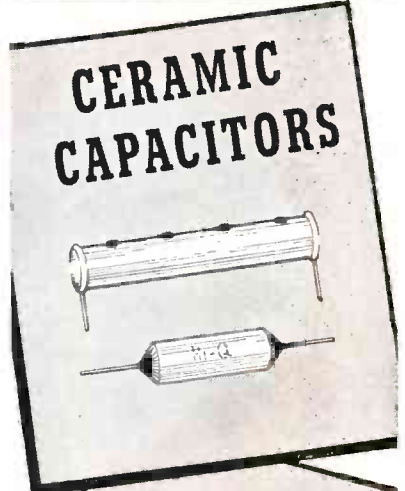





**AN EAR  
FOR AN ANTENNA**

HAROLD E. EDGERTON

The night flight of a bat is controlled by a high-frequency system not unlike Radar . . . very simple . . . very effective . . . perfectly adapted to the needs of a bat.

Antennas play a highly important part in Radar as well as communications. Like the bat's ear, they should be designed to fit the needs of a particular situation. We at the Workshop have been manufacturing antennas to meet the most exacting electrical and mechanical specifications. Our facilities include electronic test equipment for measuring antenna gain, pattern, and impedance, enabling us to fill nearly any antenna need.

If you have an antenna problem in the very high, ultra high, or microwave frequencies, whether it be for war today, or peace tomorrow, drop us a line — we are anxious to serve you.

ELECTRONICS — August 1945



---

**The WORKSHOP  
ASSOCIATES**

*Antenna Manufacturers*

FOR THE ELECTRONIC INDUSTRY

66 NEEDHAM STREET • NEWTON HIGHLANDS 61, MASS.

---



## For more than 10 years

we have been manufacturing crystals. Not only are we crystal manufacturers, but crystal specialists as well. Consult us on your "crystal problems".



### PETERSEN RADIO CO.

Council Bluffs, Iowa  
CRYSTALS EXCLUSIVELY SINCE 1934

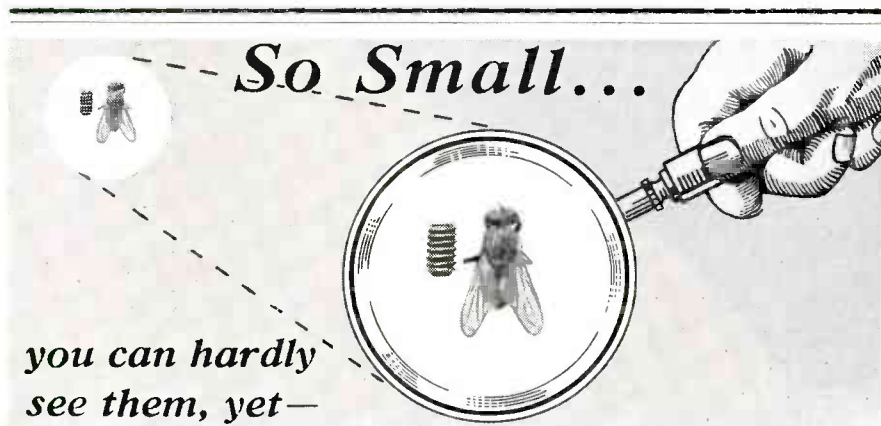

## "PERFECT IN EVERY DETAIL"

Invaluable in the field of electronics, radio and fine instruments are these "UNBRAKO" SOCKET SET SCREWS—now made in such extremely small sizes that you can hardly see them.

The knurled cup-point of this unique "UNBRAKO" Socket Set Screw digs in, holds tight—makes it a *Self-Locker*. Vibration positively will not loosen it, yet it is easily removed with a wrench and may be used over and over again.

Sizes from #0 to 1" diameter—all commercial lengths.

Where the Knurled Cup Point "Unbrako" cannot be used, use our Knurled Thread "Unbrako"—also a Self-Locker regardless of the style of point.

Write for the Catalog of "Unbrako" Socket Screw Products.



Knurling of Socket  
Screws originated  
with "Unbrako"  
years ago.

### STANDARD PRESSED STEEL CO.

JENKINTOWN, PA. BOX 596

Branches: Boston • Detroit • Indianapolis • Chicago • St. Louis • San Francisco  
OVER 40 YEARS IN BUSINESS



Pat'd & Pats. Pend.



Reg. U.S. Pat. Off.  
SELF-LOCKING  
HOLLOW SET SCREW

superchargers, which accommodated magnetic, electrostatic or photoelectric pickups with frequency dividers which were used to drive a synchronous motor powering the final Kollsman tachometer; a unit to determine the bearing loading in gyro flight instruments which measured the speed of the rotor, its negative acceleration when coasting, and vibration when rotating at high speed; and a chromatic stroboscope which measured speed or frequency of various pieces of equipment, by converting the alternating quantity to be measured into an audio signal which was fed to a discharge tube producing flashes of light to illuminate a series of stroboscopic disks rotating at various speeds.

### The Broadcast Business

FINAL FIGURES from FCC show that the 836 standard broadcast stations reporting had a 1944 income of \$68,888,110; 47 percent above 1943 and 125 percent over 1942. Average income per station rose from \$36,488 in 1942 to \$55,948 in 1943 to \$82,402 in 1944.

In the power category from 1 to 2½ kw, 137 commercial broadcast stations of the nation's 162 had net time sales for 1944 which were 41 percent above 1943. All but two reported increases. In the bracket between 5 and 20 kw, 191 of the nation's 225 standard broadcast stations netted an increase of 28 percent, with increases by all. For 383 of the 446 standard broadcast stations operating between 200 and 500 watts of power, the increase was 40 percent over corresponding figures the year before.

### JETEC Chairmen

PRELIMINARY ORGANIZATION of the Joint Electron Tube Engineering Council, cooperatively sponsored by RMA and NEMA, results in appointment of the following committee chairmen: pool tubes, D. E. Marshall Westinghouse Electric; high-vacuum power tubes, K. C. DeWalt, General Electric; cathode-ray tubes, Irving Lempert, Allen B. Du Mont Laboratories; vacuum sealed devices, M. A. Acheson, Sylvania Electric Products; receiving

# Time, Money and Labor Saved

## THE JOB DONE BETTER

### WITH *Metaplating* ON PLASTICS

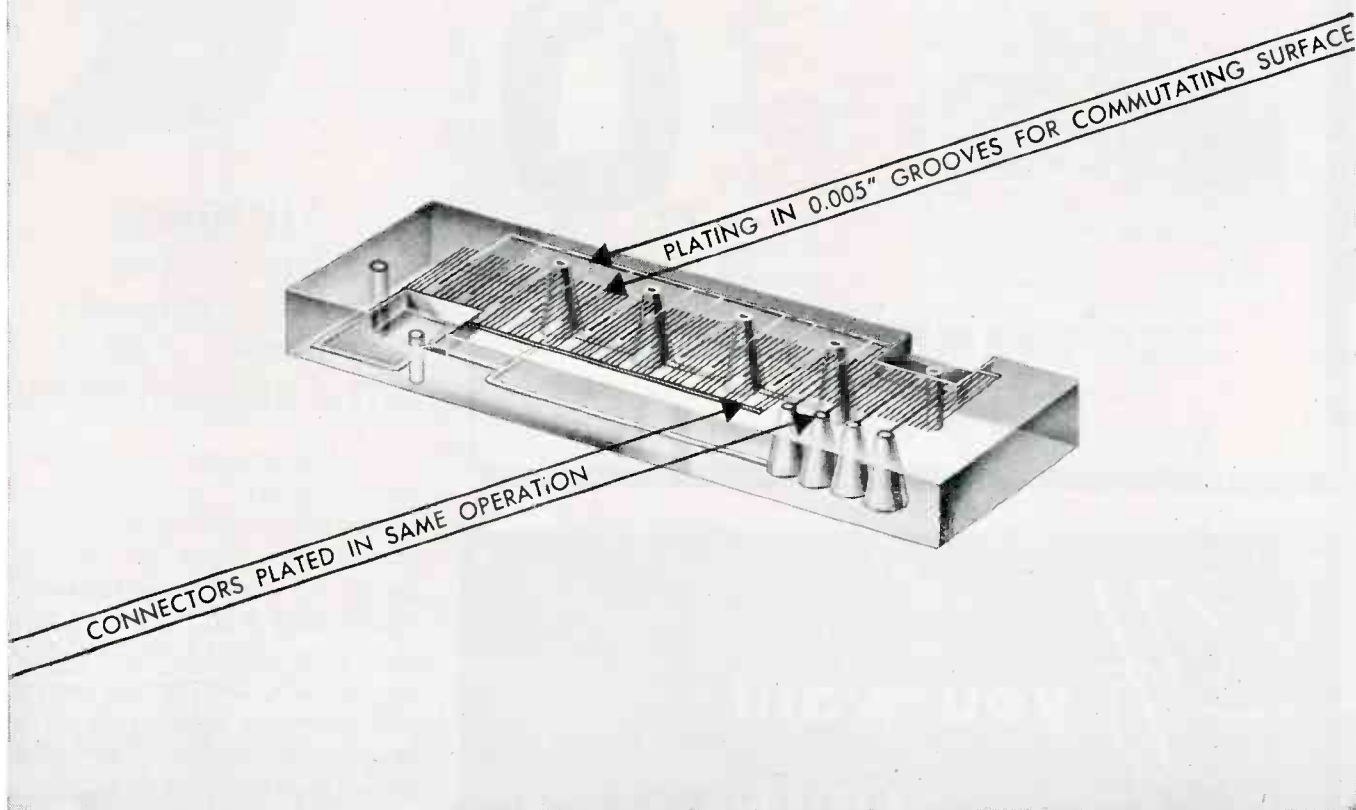

Patents issued and pending.

As new as tomorrow, are the Metaplast developments... typified by the above one-piece commutator with Metaplating connectors and commutating surfaces.

When Metaplating is used there is no need for slow, expensive, alternate stacking of conductive and non-conductive pieces... always with the bug-a-boo of clamping pressure causing cold flow of certain segments over the commutating surface... not to mention the elimination of the multitude of soldered joints.

Developed jointly by electronic engineers of the Metaplast Company and Johnson Service Company, Milwaukee, the commutator shown has sixteen conducting segments .010" thick and sixty-eight conducting segments .005" thick with separators .012" thick. The polystyrene part is so designed that each segment is simultaneously Metaplating to the proper one of three connectors... con-

nectors and segments all in one piece... manufactured in quantity at a fraction of the time and cost of yesterday's old-fashioned methods.

The molded parts vary only plus or minus .008" in length, thus eliminating separate calibration charts for each instrument in which the commutator is used. This new revolutionary manufacturing process also eliminates the troublesome gaps between conductor and insulator as well as the voltage breakdown problem between segments and mounting.

We invite you to confer with Metaplast Engineers to develop any ideas you have for bringing up to date the manufacture of commutators or similar electrical devices.



# Metaplast

## COMPANY

205 West 19th Street  
New York 11, N. Y.

Metaplast Process Patented U. S. and Foreign Patents

### M E T A L P L A T I N G O N P L A S T I C S

A Name to  
Look for on  
Electrical  
COILS and  
Transformers

# GRACOIL

"One Good Turn - or a Million"

Famous for  
years as  
COILS  
by  
DOYLE



LAYER-WOUND COIL



RELAY COIL

Be sure that the coil you buy bears the trademark name — "GRACOIL", for only then can you know that you have the best in electro-magnetic windings. Every "GRACOIL" is wound to the specified number of uniform turns from precision-gauged wire. Every "GRACOIL" is fully insulated, thoroughly impregnated, and properly laminated when supplied as a complete transformer. The most rigid inspections and tests make sure that each "GRACOIL" is worthy of the name it bears.

If your design calls for a special electro-magnetic application, let competent "GRACOIL" engineers make specific recommendations for you. Write today!



LOW VOLTAGE  
TRANSFORMER



GENERATOR  
FIELD COIL

## THE GRAMER COMPANY

Electrical Coils and Transformers

2736 N. PULASKI RD., CHICAGO 39, ILL., U. S. A.

are **7** heads  
better than **1**?



## VICTORY'S\*

Engineering Staff

and 6 Consulting Engineers  
work together ... to give you

## BETTER MOLDED PLASTICS!

If your post-war product demands injection molding to closest tolerances (like those required in the work we are now doing for the Armed Forces), you'll find VICTORY\* completely equipped to do a better job quickly, and at the lowest possible cost consistent with finest craftsmanship. Now is the

time to plan with our engineers and their consultants, so that your problems can be solved *before* you are ready to market your product.

Member: Society of the  
Plastics Industry

**Automatic  
Injection Molding**  
Small and large parts  
UP  
TO **17-OZ. SHOTS**

Lumarith, Tenite,  
Fibestos, Plastacele,  
Crystallite, Lucite,  
Ethyl Cellulose,  
Polystrene, Lustron,  
Styron, Cellulose Acetate  
and others ... all molded  
to your exacting  
specifications.



**\*VICTORY  
MANUFACTURING  
COMPANY**

1724 W. Arcade Place, Chicago 12, Ill.  
ESTABLISHED 1930

If you want

- CRYSTALS
- CABLES
- HARNESES
- ELECTRONIC  
ASSEMBLIES
- CABINETS

Telephone Peru, Indiana

151

Serving the Radio and Electronic Industries with precision engineered products.

# Wm. T. WALLACE MFG. CO.

General Offices: PERU, INDIANA

Cable Assembly Division: ROCHESTER, INDIANA

# Instruments FOR ALL PROBLEMS OF RECONVERSION

Utilities, manufacturers and maintenance contractors will find, within the broad WESTON line, instruments specifically suited to all problems of electrical reconversion . . . whether they involve quick repairs, rewiring for heavier loads, relocation of equipment, new testing stands or

laboratory installations, improved lighting, as well as for all electrical and electronic maintenance needs. Literature, or engineering cooperation on any instrument problem, is freely offered. Weston Electrical Instrument Corporation, 618 Frelinghuysen Avenue, Newark 5, N. J.

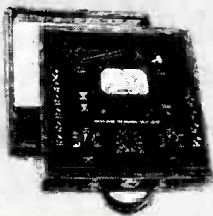

**(MODEL 785) INDUSTRIAL CIRCUIT TESTER** . . . the most versatile portable tester for laboratories, and plant maintenance, where an ultra-sensitive instrument is required. Provides 27 AC and DC voltage, AC and DC current, and resistance ranges. (dc sensitivity 20,000 ohms per volt.)



**(MODEL 796) INSULATION TESTER** . . . a direct-reading self-contained resistance tester that eliminates hand cranking. Tests up to 200 megohms at test potential of 350 to 500 volts dc., current at terminals only a few microamperes. Ranges 0-20-200 megohms, full scale . . . 0-5-5 center scale.



**(MODEL 697) VOLT-OHM-MILLIAMMETER** . . . combines a selection of AC and DC voltage, direct current, and resistance ranges in a pocket-size meter. Ideal for maintenance testing and inspection needs.



**(MODEL 633) AC CLAMP AMMETER** . . . for quick, easy current measurements on insulated or non-insulated conductors. The clamping jaws are simply clamped around the conductor, and readings taken. Circuits are never disturbed. A real time saver in electrical maintenance.

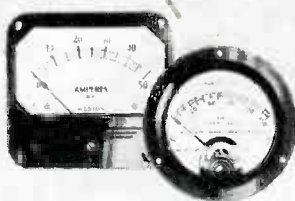

**PANEL AND SWITCHBOARD INSTRUMENTS** . . . available for all AC and DC requirements, in all types, sizes and ranges. The complete line is fully described in the WESTON Panel Instrument bulletin. Send for your copy.



**(MODEL 430) AC AND DC TEST INSTRUMENTS** . . . combine dependability, ruggedness, compactness and scale readability. Equipped with hand calibrated, mirror scales. Available for AC and DC requirements, and as DC and single-phase AC Wattmeters.



**(MODEL 703) SIGHT METER** . . . direct-reading, pocket size meter calibrated to measure light values in foot-candles, or by seeing tasks. Equipped with the WESTON VISCOR\* filter, it measures all light values direct, without correction factors.

# Weston Instruments

ALBANY • ATLANTA • BOSTON • BUFFALO • CHICAGO • CINCINNATI • CLEVELAND • DALLAS • DENVER • DETROIT • JACKSONVILLE • KNOXVILLE • LOS ANGELES • MERIDEN  
MINNEAPOLIS • NEWARK • NEW ORLEANS • NEW YORK • PHILADELPHIA • PHOENIX • PITTSBURGH • ROCHESTER • SAN FRANCISCO • SEATTLE • ST. LOUIS • SYRACUSE

In Canada, North ern Electric Co., Ltd., Powerlite Devices, Ltd.

# Follansbee

## electrical sheets and strip for every requirement



### FOR YOUR DESIGNERS

—Silicon steels which possess the precise magnetic characteristics desired for specific electrical and electronic applications.

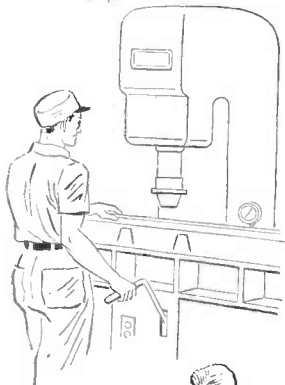

### FOR YOUR PRODUCTION MEN

—Electrical Sheets or Strip which meet high standards of punching quality, surface finish, gauge and space factor.



### FOR YOUR CUSTOMERS

—Silicon steels which function properly, which lend themselves to smooth production, make an important contribution to your manufacture of products that perform as designed . . . and which thus win the favor of customers.

★ *When placing your next order for Electrical Sheets or Strip, check with Follansbee . . . for years a leader in this field.*

## FOLLANSBEE STEEL CORPORATION

GENERAL OFFICES • PITTSBURGH 30, PA.



*Sales Offices*—New York, Philadelphia, Rochester, Cleveland, Detroit, Milwaukee. *Sales Agents*—Chicago, Indianapolis, St. Louis, Kansas City, Nashville, Houston, Los Angeles, San Francisco, Seattle; Toronto and Montreal, Canada. *Plants*—Follansbee, W. Va. and Toronto, Ohio

ALLOY BLOOMS & BILLETS, SHEETS & STRIP • COLD ROLLED CARBON SHEETS & STRIP  
POLISHED BLUE SHEETS • ELECTRICAL SHEETS & STRIP • SEAMLESS TERNE ROLL ROOFING

tubes, A. K. Wright, Tung-Sol Lamp Works; phototubes, A. M. Glover, RCA, Lancaster; gas tubes, S. B. Ingram, Bell Telephone Labs.; type designations, R. S. Burnap, RCA; mechanical standardization, E. F. Peterson General Electric; packaging, R. S. Bolan, Raytheon Mfg.; and sampling procedure, S. W. Horrocks, RCA, Lancaster.

### Drafting Standards

AT THE REQUEST of WPB, the American Standards Association (ASA) is working on a series of American War standards for drawing and drafting room practice. The objective is to correlate techniques of the Army and Navy with those of industry and should result in great economies. One large company reports that it has more than a dozen engineers presently working on the complicated problem of setting up drafting standards between subcontractors and divisions of its own organization.

Scope of the work will include civil, mechanical, electrical, aeronautical, and marine engineering and will cover abbreviations; methods of indicating and specifying threads; methods of lettering; forms and sizes of drawings; graphical, diagrammatic, and schematic symbols; methods of indicating and specifying materials and finishes; methods of dimensioning, numbering, and indicating tolerances.

### Ersatz Activities

MANY STRATEGIC MATERIALS have been supplanted by substitutes devised and developed by the U. S. Army Signal Corps, according to a recent announcement. Some of these include: low grade mica for low voltage capacitors, plastic insulation for wires, magnesium for chassis and antenna masts, plasticized ceramics as a mica substitute in capacitors, glass for insulators, rubber substitutes for vibration isolators, and meteorological balloons.

### Chile Station

STATION CB114, shortly to go on the air with the Andes as a backdrop, will be the first long-wave broadcast station to reach throughout the curving 2600-mi. length of



## CRYSTALS FOR CIVILIAN PRODUCTION

North American Philips—pioneers in the production of precision crystals by mass production techniques—is now prepared to produce quartz crystal units for the following applications:

**Aircraft Marker Beacons**  
**Aircraft Radio • Marine Radio**  
**Railroad Radio**

We will shortly have similar facilities available for the mass production of precision crystals to meet all home receiver requirements—AM, FM and television. Your inquiries and sample requests are now invited.

Our engineers are prepared to cooperate with your circuit design engineers in working out application problems involving the use of crystal oscillators or filters. A special crystal application laboratory has been set up at our Dobbs Ferry plant for this purpose.

North American Philips offers you its valuable background of experience in the development and application of crystals. As one of the largest producers of crystals for the armed forces, we are prepared to supply you with precision crystals in any quantity at an interestingly low cost.

Write, wire or phone us *now* concerning your crystal requirements and application problems.

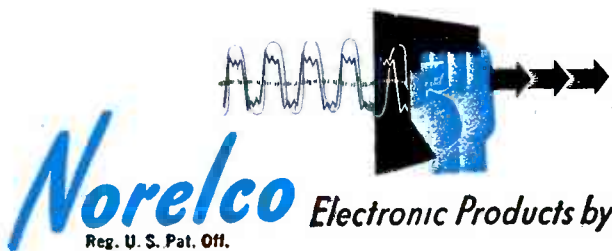

OTHER NORELCO PRODUCTS: Cathode-Ray Tubes; Searchray (Industrial X-Ray) Equipment; Medical X-Ray Equipment; Tubes and Accessories; Tungsten and Molybdenum products; Fine Wire; Diamond Dies

*We invite you to visit our office and showroom when in New York City.*

**NORTH AMERICAN PHILIPS COMPANY, INC.**

Dept. B-8, 100 East 42nd Street, New York 17, N. Y.

Factories in Dobbs Ferry, N. Y.; Mount Vernon, N. Y. (Metalix Div.); Lewiston, Me. (Elmet Div.)

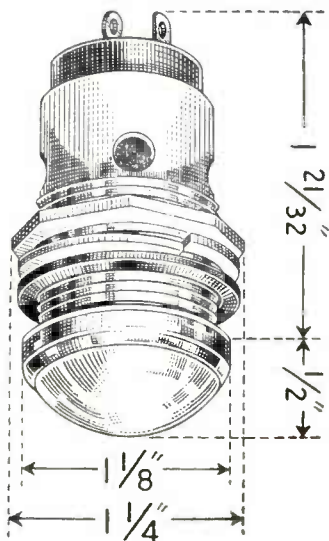

## NEW DRAKE NO. 276 JEWEL LIGHT ASSEMBLY

HERE'S a heavy duty miniature base assembly designed for use on rugged equipment. Socket assembly and mounting tube are of one piece . . . so durably built they never need replacement. Solder terminals eliminate danger of connections becoming loose thru vibration as with screw terminals. Mounts in 1" hole on panels up to  $\frac{1}{2}$ " thick. Regularly supplied with colorless, smooth glass jewel frosted on back. Your choice of colored disc placed behind jewel offers advantage of glass appearing white until lamp is lighted. #276 is only one of a big line of better Drake socket and jewel assemblies . . . standard or special types. Do you have our catalog?

**SOCKET AND JEWEL LIGHT ASSEMBLIES**



**DRAKE MANUFACTURING CO.**

1713 WEST HUBBARD ST., CHICAGO 22, U.S.A.

FOR **QUALITY**

## RADELL-BUILT PRODUCTS

• It is easy to recognize the marks of superior craftsmanship in Radell-built electronic products. With a broad basic knowledge and advanced production skill, Radell Corporation is a versatile organization specializing in the assembly and sub-assembly of highest quality electronic products.

**COMPLETE FACILITIES FOR AUDIO WORK**

**RADELL** CORPORATION

6323-37 Guilford Avenue, Indianapolis 5, Indiana

# Quality PLASTIC NAME PLATES



**FABRICATED TO YOUR  
EXACT SPECIFICATIONS**

For name plates or any other plastic parts, it will pay you to consult Sillocks-Miller specialists. This is particularly true if your products demand fabrication to close tolerances. This experienced organization can help you in four ways:

1. In working out your own ideas.
2. In developing new ideas for you.
3. In advising you on the most practical and economical methods of fabrication.
4. In selecting the right plastics for your requirements.

Remember, it costs you less to pay a little more for Sillocks-Miller quality.

Write for Illustrated Booklet

**THE SILLOCKS-MILLER CO.**

10 West Parker Avenue, Maplewood, N. J.

Mailing Address: South Orange, N. J.

Specialists in High Quality, Precision-Made Plastics Fabricated for Commercial, Technical and Industrial Requirements





## Avoid Moisture Damage in Over-Seas Packages

Simply put a few small bags of Jay Cee Silica Gel, like the ones above, inside your container . . . wrap or seal tightly . . . and ship over-seas without fear of damage from "in-the-package" moisture. Jay Cee Silica Gel is an ideal drying agent . . . has amazing power to absorb atmospheric moisture. Thus the air inside of containers is kept absolutely dry and delicate metal parts are protected from rust and corrosion.

Jay Cee Silica Gel is also used in pack-

ages of foods, fabrics, chemicals, and other products. Moreover, it has wide application in the air conditioning, refrigeration, and chemical industries. Jay Cee Silica Gel is clear white; passes a rigid section test; meets exacting Government specifications; is strictly a quality product.

**JOBBERs WANTED** — There are excellent opportunities for jobbers to build profitable business on Jay Cee Silica Gel in a few territories. Write for details.

JOLIET CHEMICALS, LTD., INDUSTRY AVENUE, JOLIET, ILLINOIS



# SILICA GEL

*A superior dehydrant*

**PUSH-BUTTON • ROTARY  
AND TOGGLE SWITCHES**

*For Low Voltage Applications*

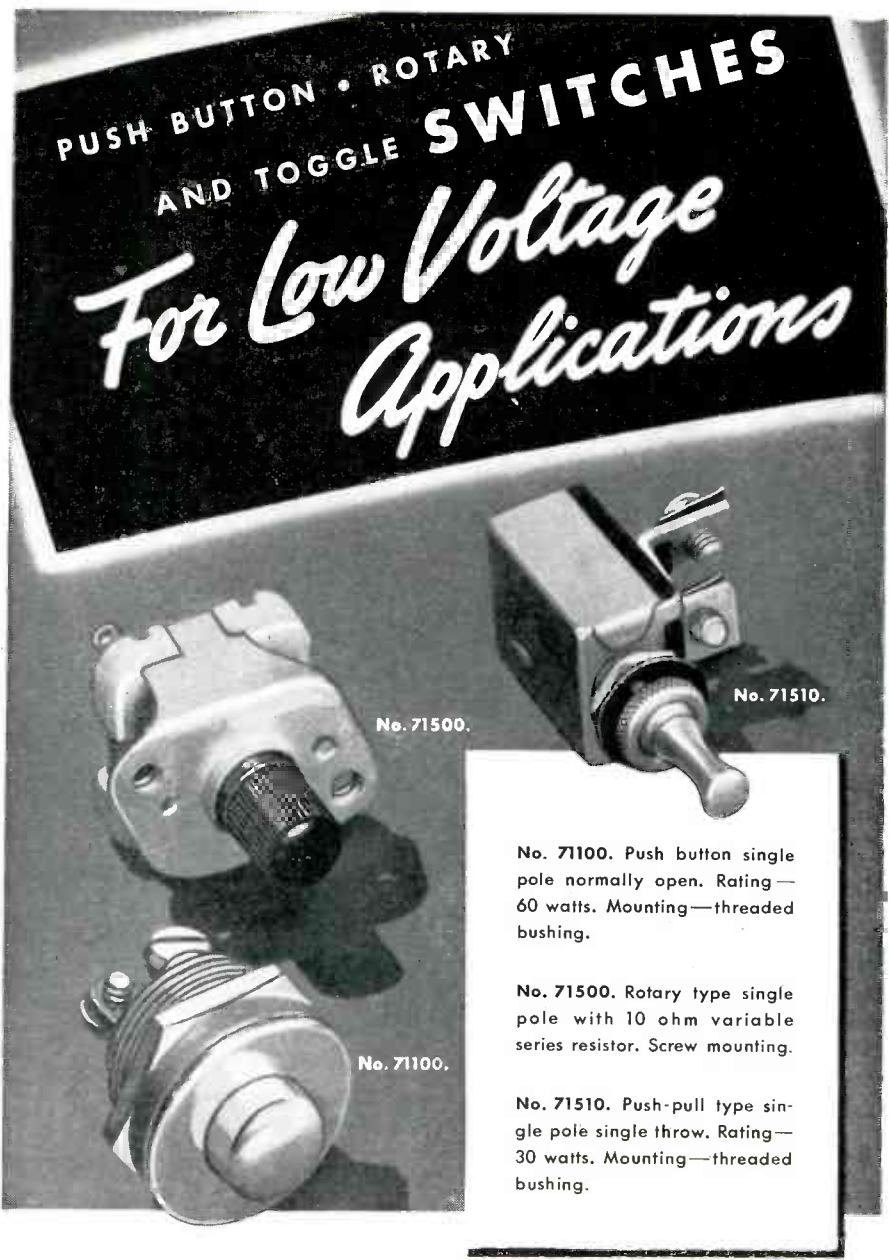

No. 71500.

No. 71510.

No. 71100.

No. 71100. Push button single pole normally open. Rating—60 watts. Mounting—threaded bushing.

No. 71500. Rotary type single pole with 10 ohm variable series resistor. Screw mounting.

No. 71510. Push-pull type single pole single throw. Rating—30 watts. Mounting—threaded bushing.

Here is a representative group of the extensive line of R-B-M electric control accessories...push button, rotary, and toggle switches; slow make-and-break contacts...now available for general purpose low voltage applications. Maximum rating, 32 volts, A. C. and D. C. For complete specifications, write Department A-8....

**R-B-M MANUFACTURING COMPANY**  
*Division of*  
**ESSEX WIRE CORPORATION**  
 LOGANSPORT, INDIANA

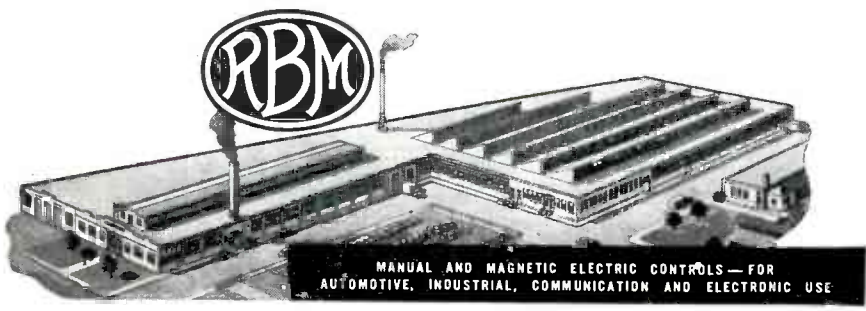

Chile from Arica to Punta Arenas.

Designed to operate with 50 kw of power, the station was planned and built by Corporación de Radio de Chile, manufacturing subsidiary of RCA in Santiago.

Coverage is possible through the use of a special-type directional antenna and an elaborate ground system which act in concert to produce an unmodulated carrier power of almost 140 kw to the north and south. Frequency, as signified by the figures in its call letters, is 1140 kc. Seven miles from downtown Santiago, the transmitter is fed from studios in the city itself.

**Electronic Education**

A \$5 MILLION PROGRAM for a Communications Institute of Arts and Sciences has been approved by the Trustees of Western Reserve University. To be located in Cleveland, Ohio, the building has already been designed. Costing \$2 million it will cover almost an acre of ground, be three stories high, and be on a more elaborate scale than any theater in existence.

**Big-Voice Anniversary**

The year 1945 marks the 30th anniversary of the electro-dynamic loudspeaker and the public address system both devised by Edward S. Pridham and P. L. Jensen, a couple of engineers working on a new wireless system. It was by accident that a special model of a wire galvanometer they were working on turned into a moving-coil telephone receiver, and another chance experiment performed by adding to this unit the horn from an Edison phonograph produced the first loudspeaker — immediately christened Magnavox as the basis for the present company of the same name. This first unit transmitted music and speech heard 4½ miles away.

**Service Orchids**

BY AND LARGE, according to a recent survey, the radio repairmen of the country have been doing a good job.

Executed for Sylvania Electric Products, the investigation revealed that there are approximately 24,700 radio service establishments in the United States, employing 60,000 people with specialized skills,



THIS FAMOUS WEBSTER RECORD CHANGER  
ASSURES A *flawless flow* OF RECORDED MUSIC

...it's **NOW AVAILABLE** on Rated Orders

The value of Webster Model 26 Record Changer can be measured by the following outstanding features—all of which combine to produce a flawless flow of music and enjoyment.

- ★ Capacity to handle a large stack of standard phonograph records. Ten 12"—or twelve 10" records can be loaded at one time.
- ★ Light needle pressure—means longer record life, more enjoyment, greater economy.
- ★ Thirty-five minutes of musical pleasure at one sitting—a greatly appreciated convenience.
- ★ No noise distraction—Model 26 operates quietly.
- ★ Easy on records is the velvet soft, heavy pile turntable covering.
- ★ Dependable, trouble free operation—it will last for years.

BUY AN EXTRA  
WAR BOND  
TODAY  
SPEED VICTORY ON ITS WAY



ASK YOUR  
DISTRIBUTOR  
ABOUT IT!

WEBSTER  CHICAGO

3825 W. ARMITAGE AVENUE  
CHICAGO 47, ILLINOIS

31 YEARS OF CONTINUOUS SUCCESSFUL MANUFACTURING

# Private-brand radios for America's best retailers!

- Retail Chains, Furniture Chains,
- Department Store Buying Combines

**DO YOU PLAN TO SELL FROM  
5,000 TO 20,000 RADIOS A YEAR? . . .**

*We will make:*

- ✓ 5- and 6-tube AC-DC table model radios in bakelite, catalin and wood cabinets
- ✓ Table radio-phonograph combinations
- ✓ Portable phonographs

Our policy has consistently been to keep costs at rock-bottom; to accept orders only when we can fill them and live up to agreed-on terms. We welcome inquiry.



## ESPEY

First of the pre-war radio manufacturers in the New York Metropolitan area to win the Army-Navy "E."  
**MANUFACTURING COMPANY, INC.**

33 WEST 46th STREET, NEW YORK 19, N. Y.

BRYANT 9-2300

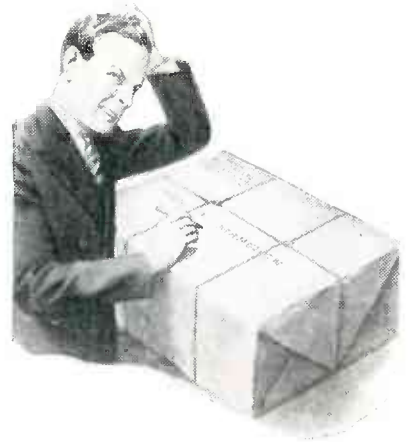

# Is it 486 or 864 Main St. ?

A shipment is guided to its right destination, or the wrong one, by the address. Experience has proved the value of these suggestions for marking shipments:

- 1 Show name of both shipper and consignee *in full on two sides* of shipment, and place duplicate address or invoice inside.
- 2 Street address, including number, building name, room number.
- 3 The state name in full, or approved abbreviation.
- 4 If old container is used, eliminate all old marks, tags or labels.

For further information, inquire of your local Railway Expressman. He is a good man to know.

BUY MORE

WAR BONDS



NATION-WIDE

RAIL-AIR SERVICE

## Fungus-Proofed Waxes

As a vital service to the Armed Forces we now offer Fungus Resistant Materials. These recently developed products are the answer to Communications requirements where the impregnation or coating of radio parts and equipment are concerned.

ZOPHAR waxes and compounds meet every specification of both the Army and Navy for waterproofing and insulating all electrical and radio components. They also have wide application in packaging of every description.

# ZOPHAR MILLS

INC  
112-130—26th STREET ESTABLISHED 1846  
BROOKLYN, N.Y.

NATIONAL RECEIVERS ARE THE EARS OF THE FLEET

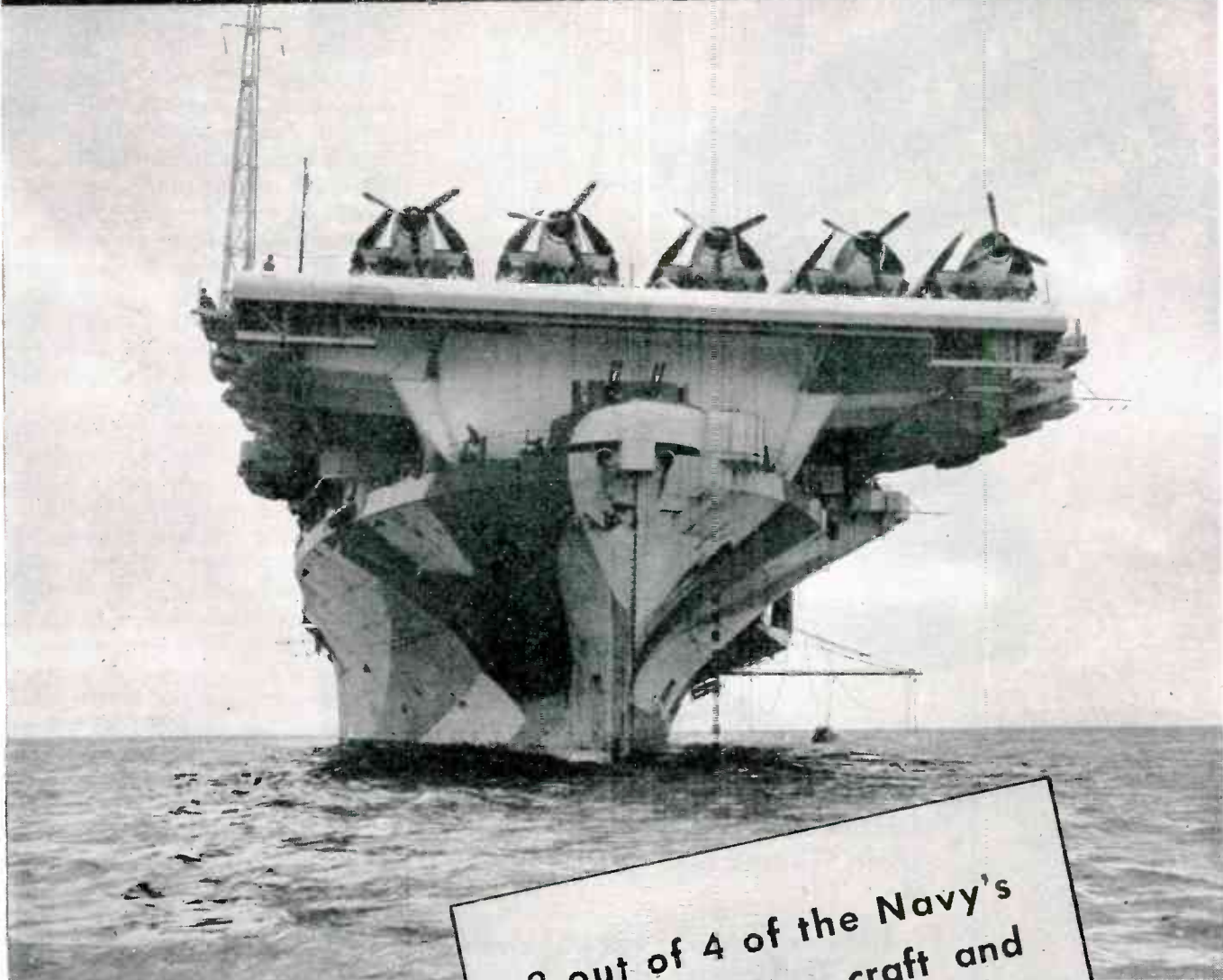

U. S. S. HORNET OFFICIAL U. S. NAVY PHOTOGRAPH

3 out of 4 of the Navy's ships—landing craft and larger—use receivers designed by National.

A capital ship is no place to use anything but the finest in radio equipment.

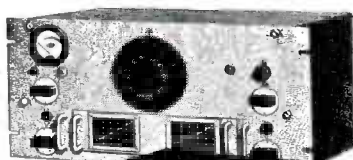

HRO

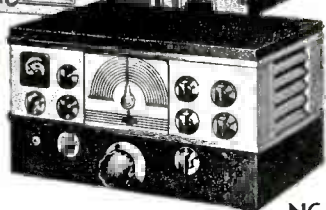

NC-200

**NATIONAL COMPANY**

**MALDEN**



**MASS., U. S. A.**

NATIONAL RECEIVERS ARE IN SERVICE THROUGHOUT THE WORLD

# POWER RESISTOR DECADE BOX



Covers resistance range of 1 ohm to 999,999 ohms.

Each decade dissipates up to 225 watts. Green-ohms (wire-wound cement-coated power resistors) used throughout. Glass-insulated wiring.

Six decade switches on sloping panel.

Maximum current per decade: 5, 1.5, .5, .15, .05 and .005 amp.

Attractive frosted-gray-metal case. Etched black-and-aluminum panel. Dual binding posts for left- and right-hand duty.

Grille at bottom, and louvres at side for adequate ventilation. Baffle plate protects switch mechanism against internal heat.

13" long, 8½" deep, 5¾" high. Weight, 11 lbs.

★ This Clarostat Power Resistor Decade Box is definitely in a class by itself. There's nothing else just like it.

Here is a power resistor decade box. That means the introduction of the correct resistance value into any circuit or for any application, for use under actual working conditions, at the mere twist of the knobs. The resistance providing the correct operating conditions is then read directly off the dials.

No calculations required. No guesswork. No time-consuming routine. The Clarostat Power Resistor Decade Box pays for itself in short order.

★ Literature on request.

**CLAROSTAT**

*Controls and Resistors*

CLAROSTAT MFG. CO., Inc. · 285-7 N. 6th St., Brooklyn, N. Y.

capable in over 90 percent of the cases of modifying circuits due to wartime scarcities. Nine out of ten changes were reported to be successful.

Specifically, it was discovered that about 40 percent of all radio repairs can be made with either tubes alone, with mechanical or electrical parts alone, or labor alone; 36 percent requiring two of these factors; 17 percent requiring three, and only 7 percent requiring four. Stated in other words, 52 percent of all repair jobs require tubes, 63 percent require electrical parts, and 31 percent require mechanical parts.

Servicemen contacted pointed out that sets failed through the fault of seven specific components in this order; tubes, capacitors, power supplies, tuning systems, i-f coils, r-f coils and filters. Interestingly enough, although tubes led the list, humidity, which does not affect them seriously, was cited as a major cause for radio servicing in an average of 44 percent of sets needing attention. Regional variations in the importance of humidity ran as follows: Pacific States 22 percent; East North Central States, 28 percent; South Atlantic States 61 percent, and Gulf States 67 percent.

Prewar, radio repair outlets sold 30 million tubes annually, but most of the servicemen feel there were too many types required and for this problem they blame the set manufacturers. While 54 percent of all servicemen stock 250 tube types, 38 percent stock 300, and 20 percent stock at least 400; 94 per-



Department store executives from major stores of the Gimbel Brothers chain watch camera scenes on the monitor board at General Electric's television station WRGB. The store people were inspecting facilities with an eye to training of sales personnel and for employee entertainment as well as for use as an advertising medium.



**TORQUE STANDARD**



**Fit YOUR Job to A**

Here's an absolute Torque-Limiting wrench that does FIT YOUR JOB, no matter what its torque troubles. It's SKYWAY'S now famous "T" torque wrench, specified by the ARMY AIR FORCES. The "T" comes in two models, 0-35 Inch Pounds, and 25-90 Inch Pounds. Both incorporate the time-saving ratcheting movement and the comfortable, hand-fitting "T" contour. Side binding, and off center-stress can't fool the "T." Write now and find how tooling with SKYWAY can save time and money for you.

REPRESENTATIVES: SEATTLE • CHICAGO • DETROIT • NEW YORK • BALTIMORE • PHILADELPHIA • INDIANAPOLIS

*Skyway*

**PRECISION TOOL COMPANY**  
3217 Casitas Ave., Los Angeles 26, Calif.

*Attention, please*

## MARINE SALVAGE COMPANIES AND DEEP SEA DIVERS

We are the exclusive suppliers to U. S. Navy of deep sea communicating equipment for divers, designed and manufactured by us.

The U. S. Navy has released this "Restricted" equipment to us for sale to commercial salvage companies and divers.

*Information on request.*

### GUIDED RADIO CORPORATION

161 Sixth Avenue

New York 13, New York

*Experience has proved...*

## ELECTRONIC ENGINEERING WAVE FILTERS DO THE JOB

This highly complex instrument is an aircraft blind landing localizer receiver. Because this equipment must operate dependably in extremes of climate and humidity, it has especially designed Electronic Engineering wave filters. Experience has proved that E-E equipment—transformers and wave filters for specialized applications—more than stand the most rugged military tests. Now, exclusively producing for the war effort, Electronic Engineering Co. will make outstanding equipment for civilian use as soon as conditions permit.



"SPECIALIZED  
*Transformer*  
ENGINEERS"

1234 WEST ARMITAGE AVENUE CHICAGO 47 ILLINOIS

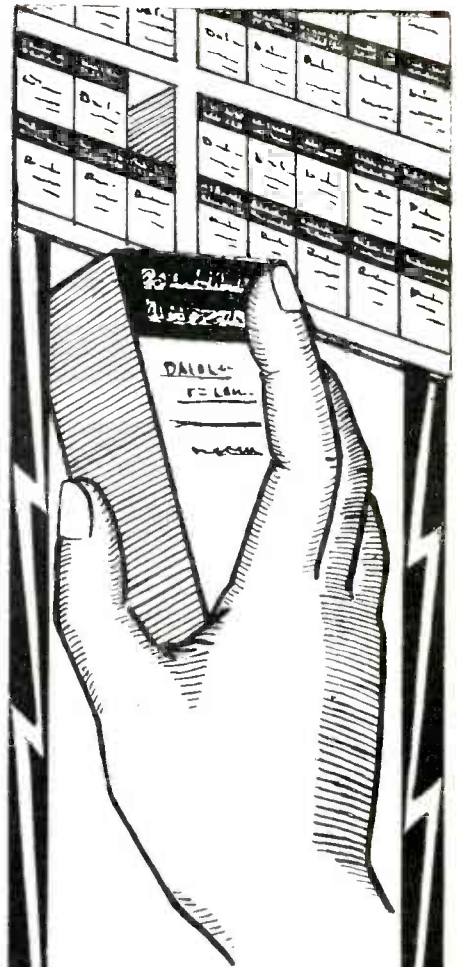

## RIGHT OFF THE SHELF!

Radio-Electronic  
Parts and  
Materials

To fill your priority  
needs . . .

IN A HURRY!



'Phone, wire,  
or write

# H. L. DALIS

Wholesale Distributors  
RADIO-ELECTRONIC SUPPLIES & PARTS  
17 Union Square  
NEW YORK 3, N. Y.

Phones: ALgonquin 4-8112-3-4-5-6-7





**GRAPHITE . . . .0000027 per °C—or lower**

**MATERIAL A . . . .00000545 per °C**

**MATERIAL B . . . .0000065 per °C**

## **. . . . COMPARE GRAPHITE'S COEFFICIENT OF EXPANSION!**

The coefficient of expansion of "National" High Purity Graphite is approximately one half that of the next best electronic-tube anode materials. This coefficient is virtually constant up through temperatures far in excess of a tube's peak operating range.

The relatively low coefficient of expansion of "National" graphite anodes assures greater stability of form at maximum tube temperatures.

Furthermore, because graphite anodes carry off heat rapidly, other tube components are far less apt to warp or change

their positional relationship. And the anodes themselves, even when of large area, are safe from local overheating.

The newest grades of "National" Electronic Graphite possess much greater strength, finer grain structure, smoother machined or machinable surfaces, in addition to greatly increased erosion resistance.

We welcome the opportunity to discuss with engineers and manufacturers the many advantages of "National" Electronic Graphite for both small and large tube components.

The word "National" is a registered trade-mark of National Carbon Company, Inc.

**Let's get the Jap—and get it over!**

★ BUY UNITED STATES WAR BONDS ★

### **NATIONAL CARBON COMPANY, INC.**

*Unit of Union Carbide and Carbon Corporation*



*General Offices: 30 East 42nd Street, New York 17, N. Y.*

*Division Sales Offices: Atlanta, Chicago, Dallas, Kansas City,  
New York, Pittsburgh, San Francisco*

# Weighs less than an ounce . . . but releases the whole world of *Glorious Recorded Music!*



**N**O fully satisfactory recorded sound can issue from a radio-phonograph speaker unless it is "picked up" with the utmost accuracy . . . the truest fidelity . . . by the tiny, sensitive, featherweight pickup—the true heart of record reproduction.

That is why so many makers of the highest quality radio-phonograph combinations build Webster Electric Pickups into their original equipment. Webster Electric Crystal Pickups—backed by vast engineering experience and skill in the field of sound reproduction—possess remarkable range, precise balance for the right needle pressure, light weight, most modern styling . . . The most critical music lovers appreciate the rich tonal color, the delicacy of shading, the utter faithfulness of reproduction which Webster Electric Pickups give.

You will want to know all about Webster Electric Pickups, and how they can be of value in the development of your new products and equipment. Write us for full information today.

Let's All Back the Attack  
Buy Extra War Bonds



(Licensed under patents of the Brush  
Development Company)

## WEBSTER ELECTRIC

Racine, Wisconsin, U.S.A. • Established 1909 • Export Dept.: 13 E. 40th Street, New York (16), N.Y.: Cable Address "ARLAB" New York City

**"Where Quality is a Responsibility and Fair Dealing an Obligation"**

cent said there should be fewer. 89 percent thought there should be less than 200, 79 percent less than 150, and 65 percent thought 100 would be enough.

The average serviceman was shown to stock 2.8 brands of tubes, distributed in this order of importance: RCA, Sylvania, Philco, Tung-Sol, National Union and Raytheon. 58 percent stated that quality and performance were the prime reason for brand preference. Between glass and metal types, 75 percent preferred the former.

### Phonograph Upsurge

AROUND CHICAGO, investigator working for the *Tribune* uncovered a big postwar demand for phonographs and radio-phonograph combinations.

With the objective of anticipating postwar demand among the 2,232,363 urban families in the area, the survey reveals purchases of 7.1 percent or 158,498 units during the first postwar year. Extended at an average unit price of \$224.73 this represents a dollar volume of \$35,619,256. Figures, which are being used by John Meck Industries to plan their postwar radio-phonograph production, also show that 87.7 percent of the local owners of radios did not have phonograph facilities.

### Foresters and Relay Sites

FOREST SERVICE PERSONNEL will cooperate with FCC in determination of factors affecting the selection of radio relay station sites. Working on the assumption that applications for sites will be received in increasing numbers, the two government agencies have established a joint procedure.

This will take the form of (1) examining the site to determine whether its occupancy can be authorized without conflict with the national forest or public interest; (2) indicating that such a permit would be contingent upon FCC station-approval; (3) making a report on site and other similarly useful available spots in the general vicinity; and (4) transmitting memoranda to FCC which will aid in the action to be taken.

Final permit will be given on the basis of conformity with regula-

# A Good Beginning

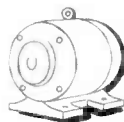

**FOR ANY PRODUCT**

## *General Plate Laminated Metals* (PRECIOUS METALS ON BASE METALS — BASE METALS ON BASE METALS)

Now, while your contemplated peace products are still in the design stages, is the time to investigate and use General Plate Laminated Metals. Available in permanently bonded combinations of precious metals to base metals and base to base metals, they provide many advantages not found in single solid metals. For instance, precious to base metals combinations give solid metal performance at a fraction of the cost of silver. In addition, they provide unusual corrosion resistance, ease of fabrication, exceptional electrical performance, long wearing life,

ease of soldering, and mechanical and structural properties not obtainable in solid metals.

No matter what you are planning, peanut radar tubes, contacts or giant turbines, you'll find General Plate Laminated Metals a good beginning in designing your products. They are available in sheet, tube and wire form . . . inlaid or wholly covered . . . or as completely fabricated parts. Many new metal combinations, developed since the war, are also now available. Our engineers will gladly help you with your metal problems. Write for their services.

### **GENERAL PLATE DIVISION**

OF METALS & CONTROLS CORPORATION

50 Church St., New York, N. Y. • 205 W. Wacker Drive, Chicago, Ill. • 2635 Page Drive, Altadena, California  
Grant Bldg., Pittsburgh, Pa.

**ATTLEBORO, MASSACHUSETTS**

## Engineering applications of electrodynamic theory

A systematic, step-by-step introduction to the fundamental concepts of electromagnetism as applied to such engineering problems as antennas, wave guides, micro-wave circuits.

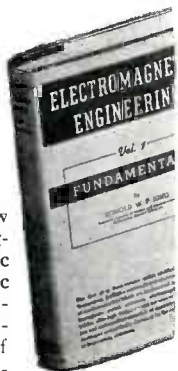

**T**HIS book offers a new approach to electromagnetism, giving a systematic introduction to those basic concepts of electromagnetism which are fundamental to the study of electromagnetic waves, antennas, electromagnetic horns, wave guides, and ultra-high frequency and microwave circuits.

Beginning with first principles, the physical and mathematical essentials of electrodynamics are logically developed and critically discussed for the purpose of applying them to engineering problems.

Just Published!

### ELECTROMAGNETIC ENGINEERING

Volume I — Fundamentals

By RONOLD W. P. KING

Associate Professor of Physics and Communication Engineering, Harvard University

580 pages, 5 1/4 x 8 1/4, 75 illustrations, \$6.00

**T**HIS simplified approach to electrodynamics gives the engineer the tools he needs to understand and keep abreast of engineering applications of time-proved physical theories. Using a logical, step-by-step method, it systematically defines electromagnetic concepts in such a way as to show the interrelation between all branches of electricity, emphasizing the fundamental analogies in electric and magnetic quantities.

- gives systematic study of skin-effect in conductors and condensers
- analyses the impedance of a condenser at ultra-high frequencies
- gives an entirely new general derivation of the transmission-line equations for two and four-wire lines
- includes a complete set of relatively simple problems to help in learning the principles of electromagnetism

#### CONTENTS

- Introduction: the Physical World and its Analogue  
 1. Mathematical Description of Matter  
 2. Mathematical Description of Space and of Simple Media  
 3. Transformations of Field and Force Equations  
 4. Electromagnetic Waves in Unbounded Regions  
 5. Skin Effect and Internal Impedance  
 6. Electric Circuits  
 Historical and Critical Retrospect  
 Appendices

SEE it 10 days • SEND this coupon

#### McGraw-Hill Examination Coupon

McGraw-Hill Book Co., 330 W. 42nd St., New York 18  
 Send me King's Electromagnetic Engineering, Vol. I Fundamentals or 10 days' examination on approval. In 10 days I will send \$6.00, plus few cents postage, or return book postpaid. (Postage paid on cash orders.)

Name .....

Address .....

City and State .....

Company .....

Position .....

(Books sent on approval in U. S. only.)

## MOLDED TERMINAL STRIPS



COMPLETELY ASSEMBLED WITH HARDWARE

Available in lengths from 1 to 20 terminals.  
 2 Types: NAS 17 and NAS 18. Prompt deliveries.



Northern Industrial Chemical Company

7-11 ELKINS ST., SO. BOSTON 27, MASS.  
 36 YEARS OF PLASTIC MOLDING EXPERIENCE

DESIGNED FOR DISCRIMINATING MANUFACTURERS



Leakproof

ENAMELED MAGNET WIRE

A product, resulting from many years of research in the field of fine wire manufacture, that meets the most rigid requirements of radio and ignition coils. A new coating method gives a smooth, permanently-adherent enameling, and mercury-process tests guarantee perfect uniformity. Great flexibility and tensile strength assure perfect laying, even at high winding speeds. If you want reduction in coil dimensions without sacrificing electrical values, or seek a uniform, leakproof wire that will deliver extra years of service, this Hudson Wire product is the answer.

QUALITY

UNIFORMITY

SERVICE

Also manufacturers of high grade cotton and silk covered wires, cotton and silk coverings over enamel coated wires, and all constructions of Litz wires. A variety of coverings made to customers' specifications, or to requirements determined by our engineers. Complete design and engineering facilities are at your disposal; details and quotations on request.

Winsted  
**HUDSON WIRE CO.**  
 Division  
 WINSTED • CONNECTICUT

No matter what the Frequency  
**BE SURE YOU'RE ON IT!**

The postwar Browning Frequency Meter, like pre-war and wartime models, will assure you of meeting FCC requirements.

Like its popular predecessors, it will be a boon to amateur, police, aircraft and other mobile services.

Continued, whole-hearted devotion of all Browning resources and facilities to war service demands prevents any "unveiling" of the new Browning Frequency Meter at this time.

When it does come, it will reflect the expressed desires of many who have written us about it. It will be exactly what you want.

*You'll be glad you waited for it!*



**BROWNING**  
LABORATORIES, INCORPORATED  
WINCHESTER, MASSACHUSETTS

# HANOVIA

## HERMETICALLY SEALED

# R. F. CHOKES

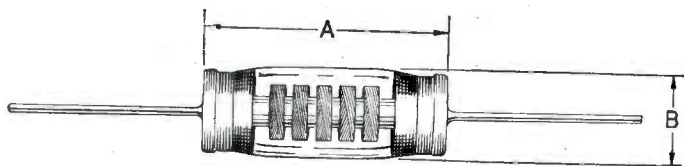

MILLI-HENRIES	A	B
1.0	1-3/4"	5/8"
2.0	1-3/4"	5/8"
2.5	2"	5/8"
5.0	2"	11/16"
10.0	3"	11/16"

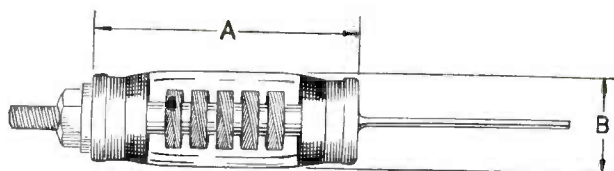

AVAILABLE IN ABOVE TWO FORMS  
RATED AT 125 M.A. FOR ALL SIZES

*Complete information on these and  
other Hanovia Chokes on request.*

# HANOVIA

## CHEMICAL & MANUFACTURING CO.

Industrial Division

Dept. E-15

Newark 5, N. J.

tions of FCC and will automatically become null and void whenever station authority is rescinded. The station must not conflict with Forest Service radio communication facilities, and also it will be understood that if FCC decides it is in the public interest to authorize joint use by another station of the apparatus and facilities installed and operated by the permittee, upon payment of a just and equitable proportion of the costs of installation, maintenance and operation, the Forest Service will have the power to authorize such an arrangement.

### French Television

DURING 1945, Le Materiel Telephonique's Parisian Eiffel Tower television station plans to conduct experiments on both 750 and 1000-line black and white images. Low power transmitters will be installed to enable field tests on 1500, 600 and 150 Mc.

Meanwhile, the pre-war 455-line transmitter with 30-kw peak power will temporarily resume operation, primarily to develop operating technique.

### Railroad Activities

SPECIAL TEMPORARY authority and construction permits have been released by FCC to a number of companies for radio activities relating to railroad communication.

Union Pacific Railroad Co. has been given temporary authority for nine experimental Class 2 radio stations for the purpose of testing the advantages which may accrue to operations from their use. Land locations are to be established at wayside railroad stations in Frankfort, Emmett, Menoken, Lawrence and Kansas City, Kans., for intercommunication between stations and with four portable and portable-mobile stations to be installed on moving trains and switch engines of the system. Frequencies will be assigned.

Aireon Mfg Corp has construction permits for one portable and two portable-mobile Class 2 experimental stations to be used in tests on the Kansas City Southern Railroad. Here again, frequencies will be assigned.

Denver & Rio Grande Western Railroad Co. has been given con-



THE STORY BEHIND  
**ESSEX**  
**EXTRA-TEST**  
**MAGNET WIRE**



**I**N FIFTEEN short years Essex *Extra-Test* Magnet Wire has reached an enviable "first-choice" position in the field.

A natural advancement—for it has always been a rigid Essex policy never to be content with just good wire. Every spool that leaves the plant must carry *extra-good* wire—the best that can be made—whether it is size 50 or 0; round, square or rectangular; bare, covered or enameled.

Such superiority is the direct result of extensive development work and severe laboratory tests. Made from commercially pure electrolytic copper,

Essex Magnet Wire is drawn to size under most careful supervision, and subjected to continuous physical and electrical tests for purity, temper, elongation, conductivity, and gauge. Insulation tests are equally frequent and severe. And in every case, *results must exceed standard requirements*. Many are far in excess of most rigid specifications.

That's why Essex Magnet Wire has been so literally labeled, "*Extra-Test*".

**ESSEX WIRE CORPORATION**  
**FORT WAYNE 6, INDIANA**

*Compare!*



**SIGNAL**

**PILOT LIGHT ASSEMBLIES**

GIVE YOU THESE 5 ADVANTAGES:

(1) Extensive line covers every known application... (2) Assemblies complete with Lamps ... (3) Top-flight engineering... (4) Personalized service ... (5) Rapid-fire deliveries.

*Write for Catalog.*

**SIGNAL INDICATOR**  
*Corporation*

894 BROADWAY... NEW YORK 3, N. Y.  
Telephone: ALgonquin 4-4770

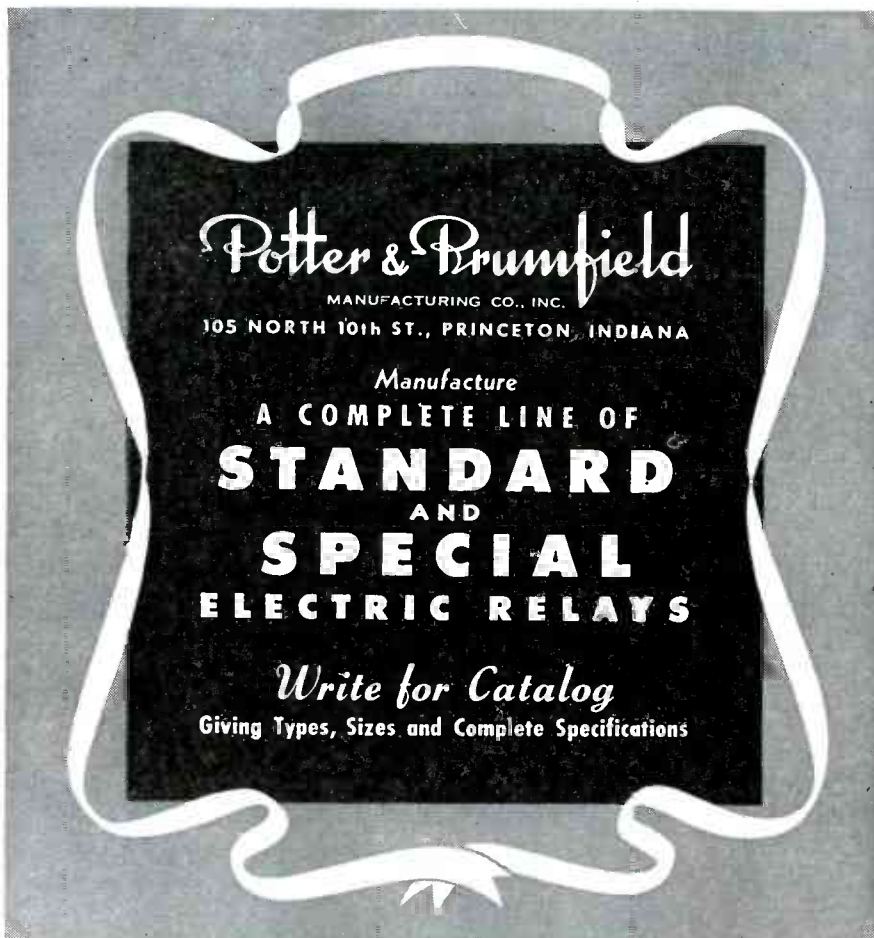

**Potter & Brumfield**  
MANUFACTURING CO., INC.  
105 NORTH 10th ST., PRINCETON, INDIANA

Manufacture  
A COMPLETE LINE OF  
**STANDARD**  
AND  
**SPECIAL**  
ELECTRIC RELAYS

*Write for Catalog*  
Giving Types, Sizes and Complete Specifications

*Simplified*

**INSULATION RESISTANCE TESTING IN INDUSTRIAL**

**Electronics**



Provided by  
**VIBROTEST**  
INSULATION RESISTANCE TESTER

**ELECTRONICS**—one of the revolutionary factors in electrical industry—calls for most accurate testing of insulation resistance in most practicable form. VIBROTEST has long proved its dependable precision with sturdiest construction —

With Synchronous Vibrators dependable for top performance — longest service.

With self-contained power source, 2 No. 6 dry cells of highest quality mounted in base. (Replacements obtainable anywhere).

With easiest operation.  
No cranking.  
No leveling.



**MODEL 201**

One of 36 Vibrotest Models, covering every service

Model 201 for general duty has a range of 0-200 megohms at 500 volts potential, 0-2000 ohms, 150-300-600 volts AC or DC. Compact, versatile, portable. Strong metal case, complete with cover and leather strap handle for carrying.

**SEND FOR COMPLETE BULLETINS**

Ask about new Model 238 calibrated 20,000 megohms at 500 V. DC, attaining a new high in precision insulation resistance testing equipment. Also HYPOT Insulation breakdown tester. VIBROGROUND, for ground resistance measurements, VOLTAMMETER for both A.C. voltage and amperage, etc. Research and development engineering.

Engineering Service Representatives in All Principal Cities

**ASSOCIATED**   
**RESEARCH,**  
*Incorporated*

223 South Green St., Chicago 7, Ill.





**"I SEE IT CLEARLY, GENTLEMEN... COILS... COILS... COILS  
...IT IS ALBION THAT CAN SHIP ALL YOU NEED."**

**SUPER-QUALITY COILS AT REASONABLE PRICES**

More and more every day, the industry is turning to Albion for fast, quality and quantity production of coils, chokes, and transformers. That's because here you benefit from the unbeatable combination of management "know how," skilled workmanship, streamlined facilities, and central location. Your requirements will be given prompt and thoughtful attention.

ELECTRONICS — August 1945

**ALBION  
COIL COMPANY**

ALBION, ILLINOIS

R. F. AND TRANSMITTING COILS AND CHOKES;  
I. F. TRANSFORMERS

**MOTOR DATA**  
No. 126



**2300 FRAME MOTOR**  
1/5 HP at 3800 RPM

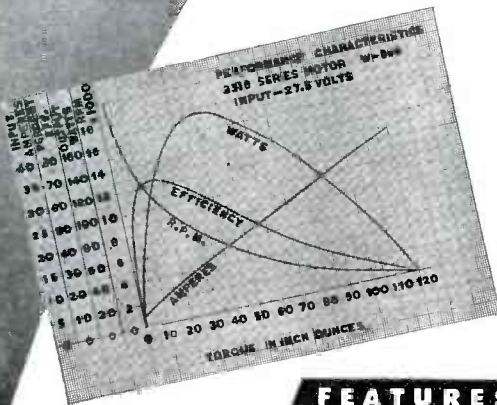

The basic design of the 2300 Frame Motor has been used in scores of individual modifications. Many of these designs are complete and available—others for new equipment can readily be developed.

**FEATURES**

**ELECTRICAL**

- Series or shunt wound
- High starting torque
- Low starting current
- High efficiency
- Low RF interference
- Unidirectional or reversible
- Armature and field windings varnish impregnated and baked

**MECHANICAL**

- Low weight factor
- Unusual compactness
- Completely enclosed
- Base or flange mounting
- Laminated field poles
- Precision ball bearings
- Segment-built commutator
- Permanent end play adjustment

2300 FRAME MOTORS		2318 Series	2310 Shunt
Watts Output, Int.	(max.)	160	50
Torque at 6000 RPM	(in. oz.)	40	10
Torque at 3800 RPM	(in. oz.)	57	—
Lock Torque	(in. oz.)	120	14
Volts Input	(min.)	5	5
Volts Input	(max.)	110	28
Temperature Rise	(int.)	50°C	50°C
Diameter		2 <sup>5</sup> / <sub>16</sub> "	2 <sup>5</sup> / <sub>16</sub> "
Length less shaft		4 <sup>3</sup> / <sub>32</sub> "	2 <sup>3</sup> / <sub>4</sub> "
Shaft Dia.	(max.)	.312"	.312"
Weight	(lbs.)	2.4	1.5

**EICOR INC.** 1501 W. Congress St., Chicago, U. S. A.  
DYNAMOTORS • D. C. MOTORS • POWER PLANTS • CONVERTERS  
Export: Ad Auriema, 89 Broad St., New York, U. S. A. Cable: Auriema, New York

struction permits and licenses for two new experimental Class 2 portable and portable-mobile stations to be installed on a locomotive and a caboose for conducting experiments along the railroad's main line between Denver, Colo. and Salt Lake City, Utah. Bendix type 522 transmitters will be used.

The electronics division of Maguire Industries, Inc. has been granted construction permits for nine experimental Class 2 stations (3 portable and 6 portable and portable-mobile) to be used in connection with general experimental work on various railroads. Initial installations are to be on the Reading Railroad in the Philadelphia area. Frequencies will be assigned.

**Facilities for Pure Research**

CONSTRUCTION OF A new laboratory to house an enlarged staff of fundamental research scientists has been voted by the board of trustees of General Electric Co. As soon as WPB approval is obtained, work will begin on the eight million dollar laboratory to be built on a 219-acre estate on the Mohawk River about five miles east of Schenectady, New York. The rolling



terrain provides hills from which test radar signals can be beamed and valleys in which million-volt x-ray radiation will be confined.

In making the announcement, Charles E. Wilson, president of General Electric, said that this proposed expansion of pure research was being carried out as a vote of confidence in America's future and as a tribute to the scientists who have compressed into the four or five years of this war developments that in less pressing times would have required 20 or 25 years.

Dr. C. G. Suits, head of the research laboratory, explained that the new laboratory will provide 50 percent more space than present facilities and that the grounds will

# REVERE TUBE FOR ELECTRONIC USES

The tubes shown here happen to be made of aluminum. We also furnish shapes in magnesium, copper, copper alloys and welded steel.

Revere tube may be used for structural purposes in radio equipment, and for parts such as shafts, rivets, soldering and solderless connectors and conductors.

In addition to tube, we also supply to the electronic industry rod and bar, sheet and strip, in copper and its alloys, for use in variable condensers, vacuum tubes, anode radiators, transmitter and receiver shields, sub-bases and similar parts. Of special interest at present is the *new* Revere Freecutting Copper, setting new standards in quick, economical and accurate machining.

We have assisted a number of manufacturers in the electronic industry solve difficult problems encountered in the selection and working of aluminum, magnesium, copper and its alloys. Through the Revere Technical Advisory Service similar cooperation is offered to you without obligation.

## **REVERE** COPPER AND BRASS INCORPORATED

Founded by Paul Revere in 1801  
Executive Offices: 230 Park Avenue  
New York 17, N. Y.

Mills: Baltimore, Md.; Chicago, Ill.; Detroit, Mich.;  
New Bedford, Mass.; Rome, N. Y.—Sales Offices in  
principal cities, distributors everywhere.  
Listen to The Human Adventure on the Mutual  
Network every Wednesday evening,  
10 to 10:30 p.m., EWT.

TWO BOOKS EVERY ENGINEER NEEDS

# THE CATHODE-RAY TUBE AT WORK by John F. Rider

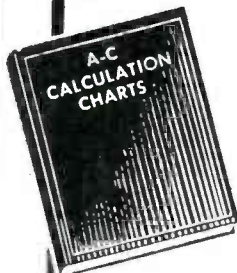

The cathode-ray tube is the most universally used device for research, engineering and maintenance in the radio and electrical fields.

In using this device to its fullest capabilities, it is necessary to understand its theory and functioning. This book presents a complete explanation of the various types and what role each element within the device plays. Different types of cathode-ray oscillographs are discussed.

More than half the book is devoted to the practical applications illustrated with unretouched photographs of actual oscillographs.

338 PAGES . . . 450 ILLUSTRATIONS . . . \$4.00

## A-C CALCULATION CHARTS

This book is a tremendous time saver for engineers and others who work on electrical communication and electrical power problems. Faster than a slide rule. It covers all alternating current calculations in series circuits, parallel circuits, series-parallel and mesh circuits, at frequencies from 10 cycles to 1000 megacycles. 146 Charts—7" x 11"—Two colors—\$7.50.

**JOHN F. RIDER Publisher, Inc.**  
404 Fourth Avenue, New York 16, N. Y.

Export Division:  
Rocke Int. Corp.  
13 E. 40th Street  
New York City  
Cable: ARLAB

# New INLAY PROCESS

## ELIMINATES NAME PLATES ON FRONT PANELS

A proven method for placing durable characters on metal panels, chassis, etc.

- ★ Inlaid baked enamel characters, protected by background finish; resistant to abrasion and salt spray; guaranteed to pass 50 hour salt spray test. NOW available in luminous characters, if desired, either phosphorescent or fluorescent.
- ★ Front panel will match finish of cabinets.
- ★ Recommended and endorsed by scores of manufacturers of electronic, sound and communication equipment.

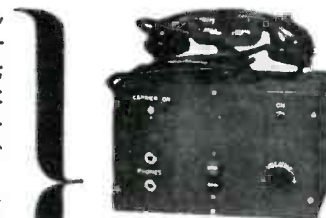

PROMPT DELIVERIES—Send us your bare fabricated steel and within two weeks we will return it finished and marked to your complete satisfaction.

# SCREENMAKERS

64 FULTON STREET • NEW YORK 7, N. Y.

Tel.: REctor 2-9867

ALSO . . .  
SILK SCREENING on front panels and chassis, either metal or plastic. Sharp clear characters durably printed on finished or unfinished surfaces.

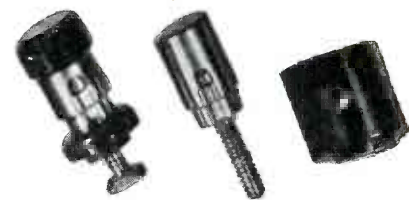

**THERE IS NO SUBSTITUTE FOR EBY SPRING BINDING POSTS**

From the product designer through to final assembly and use in the field, the Eby Spring Binding Post line offers top service based on dependability.

The spring binding post offers unique advantages that can't be duplicated:

1. No screw cap to tighten or come loose with vibration.
2. Constant, even pressure on the wire at all times in all positions.
3. Easy one-hand feeding of wire into the post.
4. Corrosion - resistant, long-life springs.
5. Complete range of sizes, stem lengths, and accessories for every application.

Replace with Eby Spring Binding Posts — Write today.

HUGH H.

# E B Y

INCORPORATED  
18 W. CHELTEN AVE.  
PHILADELPHIA, PA.





HERE'S THAT NEW  
**TRIPLETT**  
**625-N**

## LONG SCALE, WIDE RANGE VOLT-OHM-MILLIAMMETER

### DOUBLE SENSITIVITY D. C. VOLT RANGES

0-1.25-5-25-125-500-2500 Volts,  
 at 20,000 ohms per volt for greater accuracy on  
 Television and other high resistance D.C. circuits.  
 0-2.5-10-50-250-1000-5000 Volts,  
 at 10,000 ohms per volt.

### A. C. VOLT RANGES

0-2.5-10-50-250-1000-5000 Volts,  
 at 10,000 ohms per volt.

### OHM-MEGOHMS

0-400 ohms (60 ohms center scale)  
 0-50,000 ohms (300 ohms center scale)  
 0-10 megohms (60,000 ohms center scale)

### DIRECT READING OUTPUT LEVEL DECIBEL RANGES

-30 to +3, +15, +29, +43, +55, +69 DB

TEMPERATURE COMPENSATED CIRCUIT FOR  
 ALL CURRENT RANGES D. C. MICROAMPERES  
 0-50 Microamperes, at 250 M.V.

### D. C. MILLIAMPERES

0-1-10-100-1000 Milliampers, at 250 M.V.

### D. C. AMPERES

0-10 Amperes, at 250 M.V.

### OUTPUT READINGS

Condenser in series with A.C. Volts for output  
 readings.

### ATTRACTIVE COMPACT CASE

Size: 2½" x 5½" x 6". A readily portable, completely  
 insulated, black, molded case, with strap handle.  
 A suitable black, leather carrying case (No. 629)  
 also available, with strap handle.

### LONG 5" SCALE ARC

For greater reading accuracy on the Triplet  
 RED • DOT Lifetime Guaranteed meter.

### SIMPLIFIED SWITCHING CIRCUIT

Greater ease in changing ranges.

Write for descriptive folder giving full technical details



# Triplet



ELECTRICAL INSTRUMENT CO. BLUFFTON, OHIO



*Higher  
and Higher*

Electronic Winding Co. has developed special high quality coils for Ultra High Frequency work. Development of our coils has kept pace constantly with the development of high frequency communications equipment and out of our intensive war experience will come a new and finer product ready to do a new and finer job on the rapidly expanding frontiers of radio communications.

# Electronic Winding Co.

5031 BROADWAY  
CHICAGO 40, ILL.

★ ★ MANUFACTURERS OF EXTRA  
QUALITY COILS FOR PRECISION  
COMMUNICATIONS EQUIPMENT

allow room for expected expansion during the next 20 years. The company has about twenty other laboratories, but these are for developmental and product research.

### MEETINGS TO COME

**NO CONFERENCE.** Due to existing restrictions and difficulties connected with travel, the second annual National Electronics Conference, originally planned for 1945, will not be held. Present intentions are that the next conference will be in Chicago during the first October following the end of travel restrictions but permitting the arrangement of a suitable program.

**OCT. 2; SOCIETY FOR MEASUREMENT AND CONTROL** (New Jersey), Air-Operated Control and Industrial Application, by E. R. Huckman; Essex House, Newark, N. J.; H. S. Close, secretary, 831 Dixie Lane, Plainfield, N. J.

**OCT. 18-20; OPTICAL SOCIETY OF AMERICA**, Thirtieth Annual Meeting; Hotel Pennsylvania, New York, N. Y.; Arthur C. Hardy, secretary, Massachusetts Institute of Technology, Cambridge 39, Mass.

### WASHINGTON NEWS

**NAVAL RESEARCH.** Under direct supervision of Naval Secretary Forrestal, a new office of Research and Inventions has been formed to guide postwar Navy research activities. Electronic research is to be coordinated through the design branch of the electrical division of the bureau of ships and the equipment branch with research projects farmed out to colleges and universities on the basis of adaptability.

**BROADCAST CONSTRUCTION.** Amendment of Limitation Order L-41 allows without special WPB permission broadcast construction jobs in amounts not exceeding \$1000. A previous \$200 ceiling existed.

**X-RAY EQUIPMENT.** Restrictions have been lifted from the shipment of X-ray equipment for civilian purposes by revocation of Limitation Order L-206. Affected equipment includes power units; radiographic, fluoroscopic, and therapy tables; photo-fluorographic units; cassette changers; and tube stands. Because production of most items

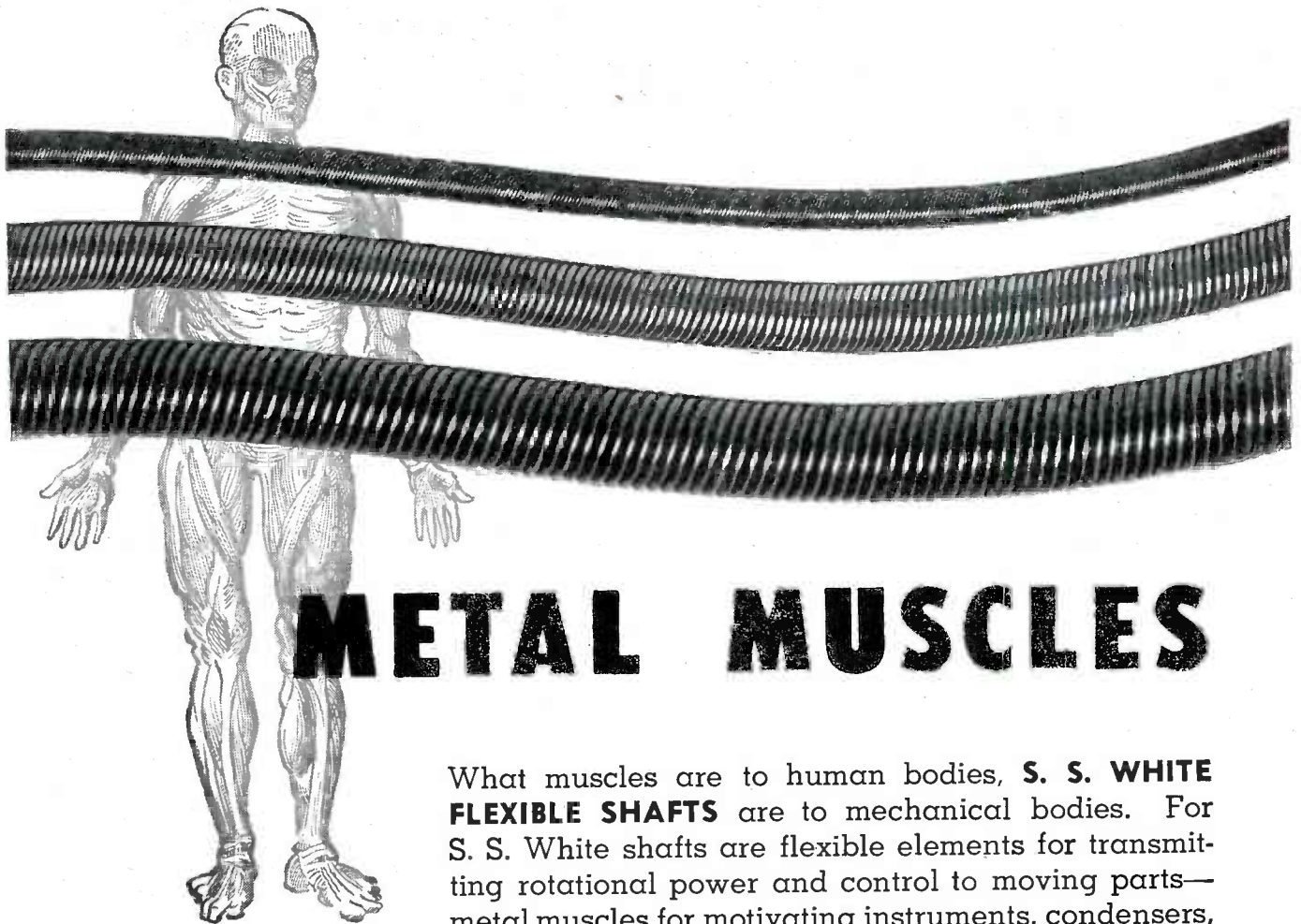

# METAL MUSCLES

What muscles are to human bodies, **S. S. WHITE FLEXIBLE SHAFTS** are to mechanical bodies. For S. S. White shafts are flexible elements for transmitting rotational power and control to moving parts—metal muscles for motivating instruments, condensers, variable resistors and other driven and controlled mechanisms—muscles that never get tired, are virtually immune from injury and function efficiently and dependably under all atmospheric conditions.

Engineers in all branches of electronics will find it worth while to familiarize themselves with the range and scope of FLEXIBLE SHAFTS for power transmission and remote control.

## COMPLETE DETAILS In This 256-Page Flexible Shaft Handbook

This standard handbook-size volume completely covers the subject of flexible shafts. It gives all essential technical data and explains how to select and apply shafts for specific requirements. A complimentary copy is yours if you write for it direct to us on your business letterhead and mention your position.



**S.S. WHITE INDUSTRIAL DIVISION**  
 THE S. S. WHITE DENTAL MFG. CO. DEPT. E, 10 EAST 40th ST., NEW YORK 16, N. Y.



FLEXIBLE SHAFTS      AIRCRAFT ACCESSORIES  
 MOLDED PLASTICS  
 MOLDED RESISTORS      FLEXIBLE SHAFT TOOLS

*One of America's AAAA Industrial Enterprises*

Get This New Booklet on



# Cellusuede FLOCK

An interesting and colorful booklet on their product has been prepared for your information and convenience by the makers of Cellusuede Cotton and Rayon Flock. Brief, clear explanations give all the facts you'll want to know about this versatile coating material; what

it is made of; how it is applied; how it can be used. In the pages of this booklet you may find the answer to one of your manufacturing problems. You will be interested, too, in the colorful and unique application of Cellusuede on the booklet cover. Write for your copy.



**PARTS?**  
ORDER TODAY FROM...

**R. W. T.**  
**WORLD'S LARGEST**  
Radio Supply House • Founded 1922

For Industrial Organizations  
Laboratories • Purchasing Agents  
Radio Dealers & Service Men  
Training Schools • Expeditors  
Amateur Operators and Experimenters

**10,000 PARTS**  
Immediately available. (Some no longer  
need priorities.) Selected and shipped  
same day your order is received.

**Radio Wire  
Television Inc.**  
100 SIXTH AVE. (DEPT. E-8) NEW YORK 13  
BOSTON, MASS. NEWARK, N. J.

Originators of the  
*Lafayette Radio*  
soon in production again

# Toroids..

by  
**DX**

Doughnut Coils for electronic and telephone purposes. High Permeability Cores are hydrogen annealed and heat treated by a special process developed by DX engineers. Send us your "specs" today—ample production facilities for immediate delivery.

**DX RADIO PRODUCTS CO.**  
GENERAL OFFICES 1200 N. CLAREMONT AVE., CHICAGO 22, ILL., U.S.A.

**DX COILS**  
"the heart of a good receiver"



# Your Navy

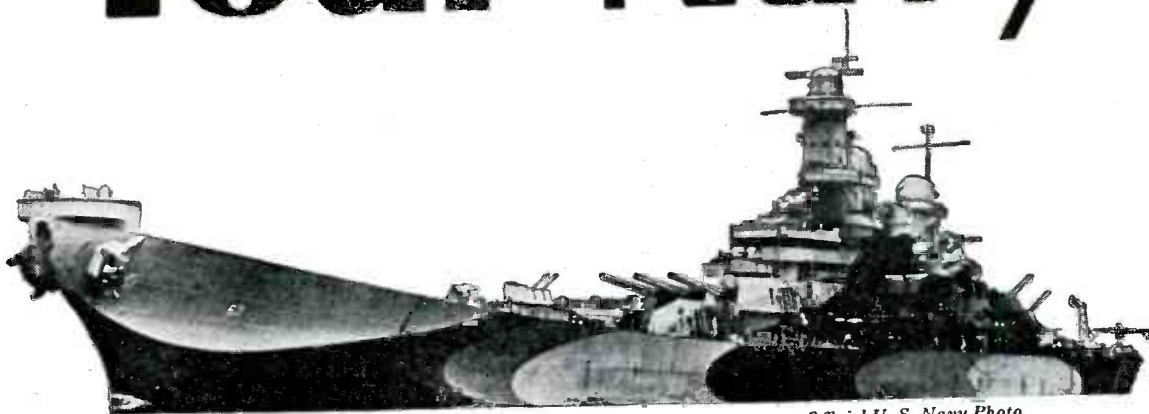

Official U S Navy Photo

## accepts nothing less than Perfection



That's why **KENYON HERMETICALLY SEALED TRANSFORMERS AND REACTORS** have been selected to play their part in the great forward march of the world's greatest Navy which demands and accepts nothing less than perfection of all its personnel and resources.

The construction employed in the unit illustrated will meet present government specifications from any branch of the armed services. **KENYON'S** high standard of quality has been diligently maintained to insure a product of perfection.

Designs available employ both glass-to-metal and steatite-to-metal sealed terminals.

Overall dimensions and mounting dimensions conform to the **KENYON** T-line case except that the mounting is single ended at top or bottom. It may be necessary to increase case height.

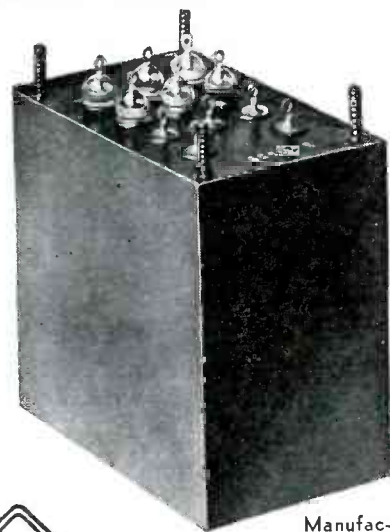

Manufactured for the Navy to their specifications RE 13A 553 B



THE MARK OF

EXCELLENCE

*Inquiries invited. Write for our new 1945 illustrated catalogue*

**KENYON TRANSFORMER CO., Inc.** 840 BARRY STREET  
NEW YORK, U. S. A.

# Burlington

## PANEL INSTRUMENTS

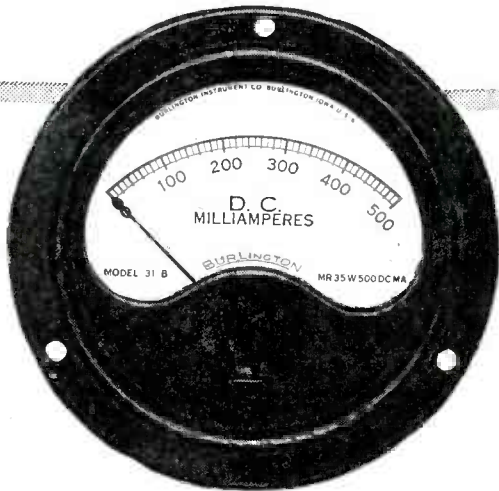

## Guaranteed ACCURACY

Due to design characteristics and close control of manufacturing processes, Burlington instruments embody the following advantages:

**PERMANENCE OF CALIBRATION . . .** All DC instruments employ Alnico magnets which are known to be more highly resistant to shock, heat, vibration, and stray fields than any other magnetic material.

**FREEDOM FROM STICKING . . .** Clearances for all moving parts are such that the results of entrance of small particles as encountered in field service are reduced to a minimum.

**STABILITY OF OPERATION . . .** All instruments are "NORMALIZED" after assembly to eliminate "zero shift" and other calibration errors due to ageing.

Exceptionally high torque to weight ratio of control springs to moving element insures minimum error under conditions of shock, vibration, and other rough usage.

Alignment of jewels and magnet core piece is such that the center lines of these parts coincide within plus or minus .002". The design of the brass movement frame and components is such that mechanical tolerances are reduced to a minimum in assembly. As a result, jewel and pivot wear is uniform which reduces "frictional torque" of the moving coil.

All series resistors and coils are heat treated and impregnated after wrapping to insure stability and long life.

All ranges AC & DC are available in 2½", 3½" and 4½" sizes, both square and round, flush mounting.

Engineering service furnished for specialized applications.  
No obligation. Write today for further information.

## BURLINGTON INSTRUMENT CO.

100 FOURTH STREET  
BURLINGTON, IOWA



PANEL INSTRUMENTS • VOLTAGE REGULATORS • AUTOMATIC SYNCHRONIZERS • FREQUENCY REGULATORS

requires six to twelve months, this equipment will not become generally available before that length of time, but production planning can be more efficiently executed, according to WPB.

**BLOCK AND FILM MICA.** Paper work incident to the use of most grades of block and film mica are being eliminated but without the removal of fabricating restrictions according to plans of WPB. Government stockpiles of high-grade and large-size mica must continue to be reserved for military demands, but it is pointed out that mica is available from domestic mines and certain foreign countries, and that users should explore the possibilities of obtaining the mineral from these sources rather than from government stocks.

**INDUSTRY RECONVERSION.** Appointments by the Committee on Period One (CPO) have been made to establish reconversion chairmen to facilitate the changeover from military to civilian production. In the communications division, the reconversion officer is Maynard A. Cook, whose responsibility will cover telephone and telegraph equipment, non-electronic military communication equipment, and radio headsets. In the radio and radar division, M. E. Karns is the reconversion officer covering vacuum tube machinery, transformers, capacitors, cable, microphones, loudspeakers, resistors, tube sockets, vibrators, test equipment, tubes, intercommunication equipment, instruments, sound systems, radio hardware, switches, repair parts, transmitters, receivers, and electronic heating generators. Control valves, regulators and industrial and commercial instruments come in the province of E. A. Capelle.

### FCC ACTS

To permit this station	To do this
WJJD Chicago, Ill.	Construct developmental station to investigate multiplex f-m operation A0, A4, and special emissions (f-m); and 3-kw power.
Dayton, Ohio	Construct developmental station for f-m research; A0, A3, and special emission (f-m); and 1-kw power.
W9XEK Louisville, Ky.	Increase power to 10 kw; add A4 emission; change frequency from 45.5 Mc to assigned frequencies and change transmitter.
W8XFM Cincinnati, Ohio	Change classification from temporary class-2 experimental high-

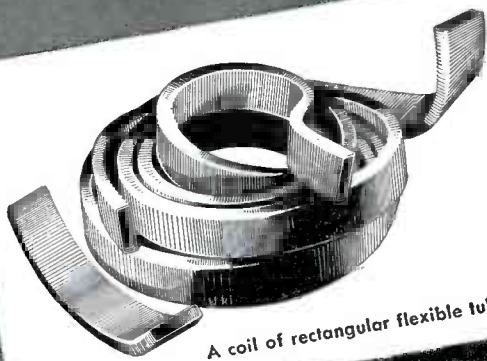

A coil of rectangular flexible tubing.

# Breeze Flexible Tubing, Shielding, Conduit Fittings

Representative of standardized Breeze shielding fittings.

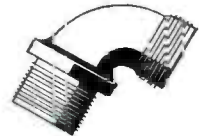
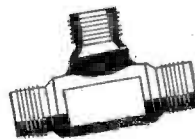

Braided wire covering forms electrical shield over flexible conduit.

● Breeze Flexible Metal Tubing solves many a design and modification problem by providing easily installed ducts and vents for air conditioning, exhaust or dust collection. Produced in a variety of metals from a continuous strip, Breeze Tubing resists heat and corrosion and is available in a variety of shapes to fit structural considerations.

Breeze Flexible Shielding Conduit is made from similarly constructed tubing with the addition of a braided wire covering which acts as a shield preventing radiation or absorption of electrical interference. Double layers of braid are sometimes specified to provide complete isolation from ultra-high-frequency interference. A variety of specially designed fittings meet every installation need.

If you are confronted with difficult tubing or shielding problems, call in a Breeze engineer for a complete analysis and recommendation.

# BREEZE

*Corporations Inc.*

NEWARK  NEW JERSEY

Square Locked, Packed.



Full Interlocked, Unpacked.



Full Interlocked, Packed.





## MOVING AIR -- 15 CUBIC FEET A MINUTE ONLY 2½" OF SPACE NEEDED

The blower illustrated, No. 1½\*, is one of many blower models manufactured by the L-R Mfg. Div. with C.F.M.'s at 8000 R.P.M. ranging from 15 to 270. These blowers will outperform many larger and heavier types formerly in use and where size and weight are factors, they are the answer to cooling problems presented by electronic tubes or circuit components in airborne communication units as well as in many industrial applications.

\*WEIGHT: 2 oz.; CAPACITY: 15 C.F.M. at 8000 R.P.M.; CONSTRUCTION: Housing of high impact phenolic plastic. Wheel is turbo-type cadmium-plated steel; SIZE: 2½" long x 61/64" wide x 2½" high.

L-R MANUFACTURING DIVISION OF

The **RIPLY** Company

13 NEW LITCHFIELD STREET  
TORRINGTON, CONNECTICUT

These diversified metal fabrications

# FACILITIES

can solve future plannings

"Resourcefulness in design can step up efficiency in assembling and manufacture. Close tolerance stamping and forming are effecting lowered production costs all along the line."



Modern and complete metal fabricating facilities — plus OLYMPIC engineering experience and resourcefulness—are at present eliminating production bottlenecks in vital phases of industry.

Whether your projected product calls for production tooling, stamping, forming, or drawing — complete design, fabricating and assembly services are available for essential manufacture. The OLYMPIC organization can provide the solution to your light and medium metal working problems.

Welded, brazed and soldered assemblies are a specialty, and work can be held to any reasonable tolerance. Finishes, according to specifications, include painting or plating.

CRAFTSMANSHIP IN METAL PARTS

**OLYMPIC**  
TOOL & MFG. CO., INC.  
39 CHAMBERS ST.  
NEW YORK 7, N. Y.

# AMCON Capacitors

**SHOCK-PROOF**  
**BATTLE-TESTED**  
**DURABLE**  
**DEPENDABLE**

American Capacitors meet the most exacting precision requirements because they are fabricated by experienced craftsmen. Electrolytic and Paper Capacitors, incorporating new plastic designs, cover all standard capacitance values and working voltages.

"There is an Amcon for every size and purpose"

**AMERICAN CONDENSER COMPANY**  
4410 RAVENSWOOD AVENUE • CHICAGO 40, ILLINOIS

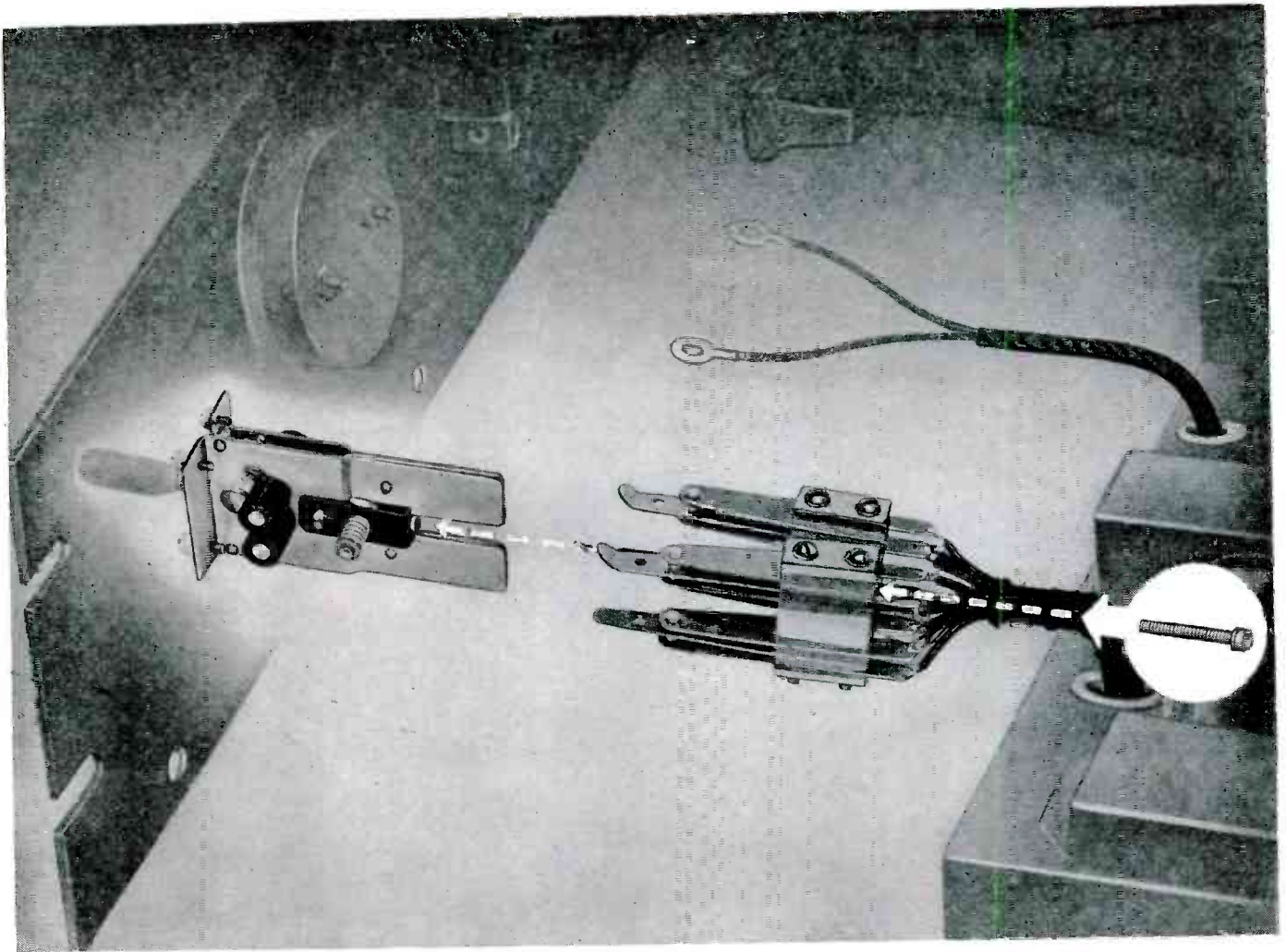

## *Single Bolt Assembly* ON MODEL MCL LEVER SWITCHES SPEEDS CHASSIS-TO-PANEL ASSEMBLY ON ELECTRONIC & COMMUNICATIONS EQUIPMENT

This *exclusive\** General Control Company feature means savings in time and labor during original assembly and at any time that maintenance, rewiring, etc. is required. Consider the convenience of this feature when build-ups must be assembled to a frame that is buried among other units on the back of the control panel. During assembly of equipment, the Model MCL can be wired where it is most convenient—the control lever can be mounted anywhere on the panel where it is most convenient for the operator—there is no need to

compromise.

The "Midget" Model MCM also has the single bolt assembly feature. This unusual lever switch *weights only 3½ ounces with 12 contact springs.*

All General Control Company lever switches have unlimited contact possibilities; all parts are non-corrosive; all have easy, positive roller action, regardless of number or arrangement of contacts on each side of switch.

\* PATENT No. 2,351,236

*The "Midget" MODEL MCM has it too!!*



**GENERAL  
CONTROL  
COMPANY**

1202 Soldiers Field Road

BOSTON 34, MASS.

ELECTRONICS — August 1945

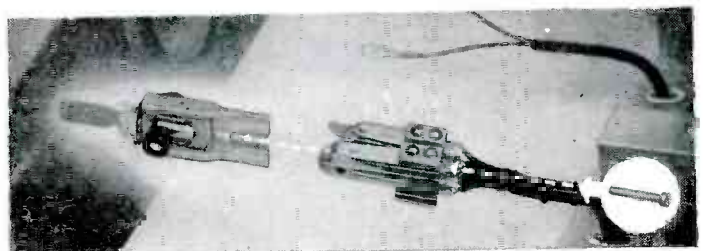

# ELECTRONIC AC VOLTMETER

*with Logarithmic Scale*

**Percentage Accuracy  
of reading is uniform  
over entire scale!**

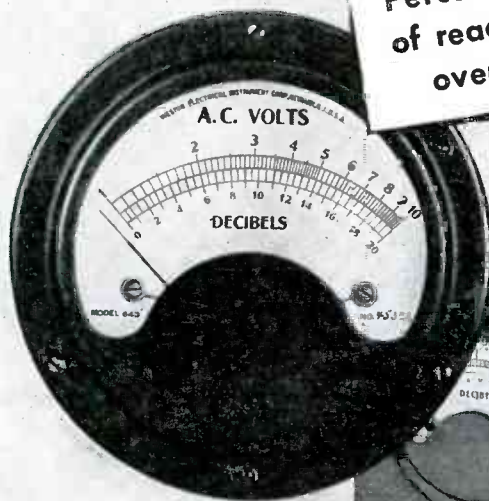

**MODEL 300  
ELECTRONIC  
VOLTMETER**

## ACCESSORIES

MODEL 220 DECADE AMPLIFIER

MODEL 402 MULTIPLIER



*Since its development in 1935 the Ballantine Electronic AC Voltmeter is the only instrument of its kind with a Simplified Logarithmic Scale.*

The important feature of logarithmic scale indication in the Ballantine Voltmeter provides the same degree of accuracy at 1 as at 10. Also the simplicity of this scale reduces errors in visual observation, common with most multi-range instruments. Finally, the care taken in overall calibration combined with the inherent stability of the circuits used permits reliable readings within the 2% specified tolerance over the complete range of operation.

Write for descriptive  technical Bulletin 8

# BALLANTINE LABORATORIES, INC.

BOONTON, NEW JERSEY, U. S. A

- |                              |  |
|------------------------------|--|
| WBCA<br>Schenectady, N. Y.   | frequency to developmental broadcast.<br>Change antenna system.  |
| W2XDK<br>Brooklyn, N. Y.     | Construct experimental television broadcast station and 10-kw visual (peak) and aural power.                         |
| WFBM<br>Indianapolis, Ind.   | Change exciter unit of main transmitter and construct a 1-kw auxiliary using d-a night.                              |
| WJR<br>Detroit, Mich.        | Change frequencies of relay station to 30,820, 33,740, 35,820, and 37,980 kc and change power from 150 to 100 watts. |
| KAZA<br>Oklahoma City, Ok.   | Move relay-broadcast transmitter and change antenna.   |
| KNAK<br>Salt Lake City, Utah | Operate new station on 1400 kc, 250 w, unlimited time.   |
| WNEX<br>Macon, Ga.           | Operate new station on 1400 kc, 250 w, unlimited time.   |
| WALV<br>Richmond, Va.        | Change call letters to WLEE  |
| Dallas, Tex.                 | Construct new portable developmental broadcast station with frequencies to be assigned and 1-kw power.               |
| New York, N. Y.              | Construct two new developmental broadcast stations and 5-kw and 10-kw power.   |

## BUSINESS NEWS

EISLER ENGINEERING Co., Newark, N. J., marks the 25th anniversary of its specialization in the design and manufacture of automatic machinery related to mass production of such glass-enveloped products as radio and electron tubes.

BENDIX AVIATION CORP. plans to manufacture on the Pacific Coast a complete line of radios and radio-phonograph combinations for marketing in that area.

BELL TELEPHONE LABORATORIES plans to double, approximately, the size of its laboratory at Murray Hill, N. J., as shown in the accom-

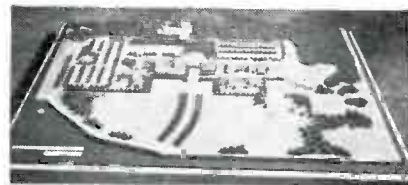

panying picture. The first and present unit of the suburban laboratory cost about \$2,500,000, houses over 1,000 people.

HALLICRAFTERS Co., Chicago, Ill., expects to pursue postwar activities in the amateur radio market; in the production of Army, Navy, and other government equipment; commercial gear for marine, aviation, laboratory, bus, and railroad fields; a high quality a-m/f-m radio and phonograph combination to be marketed under another name; in

# Down an invisible road in the sky

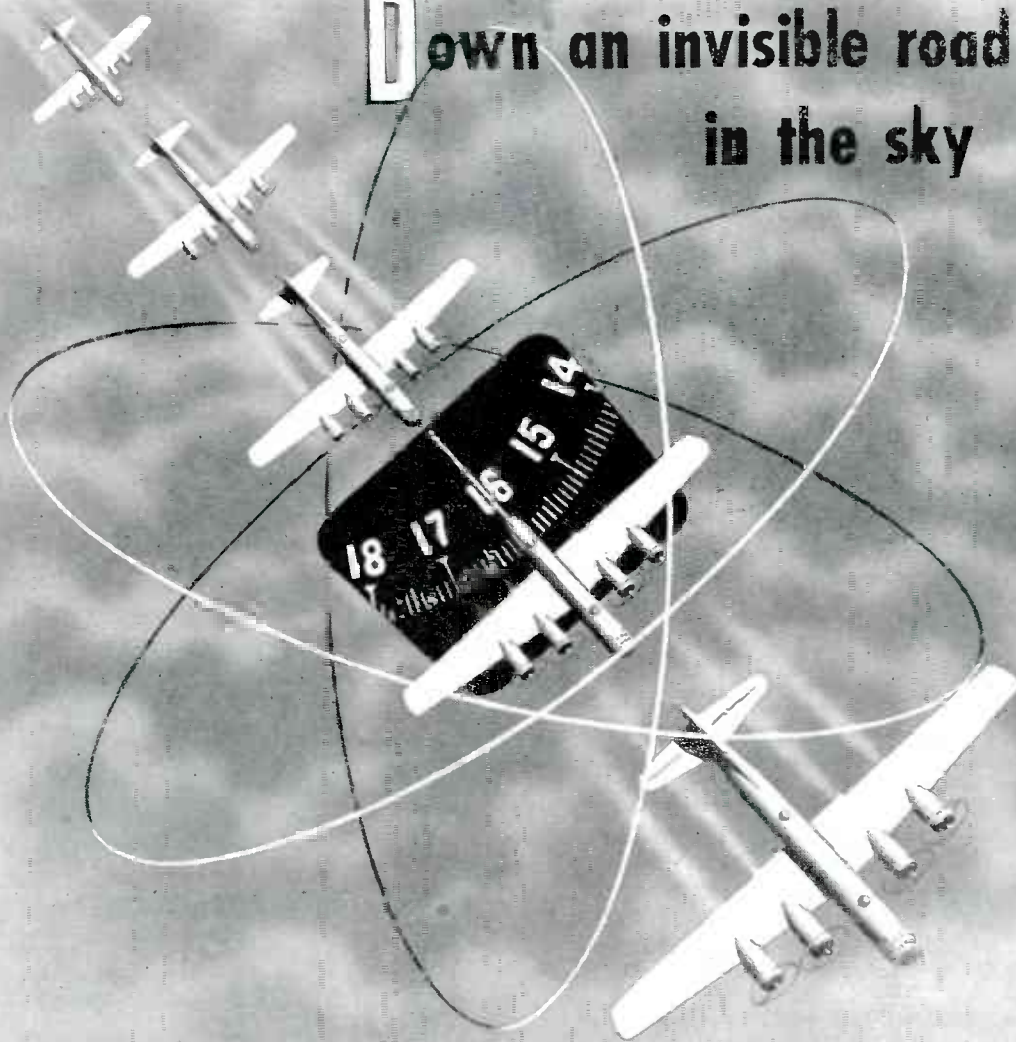

There are no road signs or clouds, yet Allied fliers, aided by electronic impulses, are daily arriving over the target after long flights over endless water. On accuracy in aerial navigation depends the success of a bombing run on Tokyo—and a safe return home. High-frequency impulses assure steady communication, aid in locating planes and ships, and coordinate movements of aircraft, armies and ships. Delco Radio Division is proud of its contribution to final Victory through the development and production of compact mobile radio sets and highly specialized electronic and radar equipment. Delco Radio Division, General Motors Corporation, Kalamazoo, Indiana.

**Delco Radio**  
DIVISION OF  
**GENERAL MOTORS**

**WAR BONDS ARE FIGHTING BONDS**

*Look at this!*  
**THE LARGEST**

**FABRICATED PLASTIC  
 PART OF ITS KIND!**

This coil form is one of a production lot fabricated in our shop; drilled with more than one hundred holes, all close tolerance as to size and location.

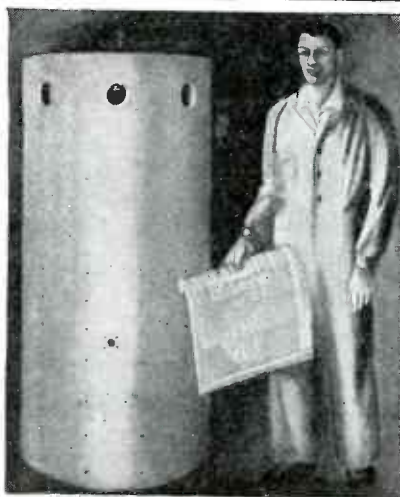

Of importance to you is our ability to furnish prompt delivery. If you are faced with a tough fabrication problem, or the necessity of fast service, a consultation with one of our organization may help you to meet your own delivery dates.

We carry a large stock of phenolic laminated sheet material and can give you prompt service on specially fabricated parts or on sheets, rods and tubes.

**ELECTRICAL INSULATION CO., INC.**

12 VESTRY ST.,

NEW YORK 13, N. Y.

**FABRICATED PHENOLIC PARTS . . . SHEETS, RODS, TUBES**

**BLOWERS for  
 Electronic  
 Equipment**

Easy-to-install . . . compact . . . quiet-running . . . economical . . . these are the features which make Pilot Blowers ideal for the important job of air circulation and ventilation in Radio Equipment. Available in standard models to move from 15 to 100 C.F.M. Write for Bulletin 507.



**SHADED POLE F. H. P. MOTORS**

Tell us what your requirements are and we will send you "fact sheets" giving complete specifications on these dependable, efficient, low-cost Motors. For continuous or intermittent duty with H.P. ratings ranging from 1/15 to 1/500 H.P. and from 1550 to 3400 R.P.M. Plain round or with base or resilient mounting . . . open or enclosed cases.



**F. A. SMITH MANUFACTURING CO., INC.**  
 801 DAVIS ST., ROCHESTER 2, N. Y. 

**SHADED POLE MOTORS *Pilot* CENTRIFUGAL BLOWERS**

**FOR  
 ELECTRONIC USE**



**SILVER**

WIRE - SHEET - TUBING  
 SILVER BRAZING ALLOYS & FLUXES

**PLATINUM**

WIRE - RIBBON - FOIL  
 SEAMLESS TUBING

WE INVITE INQUIRIES REGARDING ALL APPLICATIONS OF PRECIOUS METALS TO ELECTRONIC PRODUCTS.

PRECIOUS METALS



SINCE 1875

**THE  
 AMERICAN PLATINUM  
 WORKS**

N. J. R. R. AVE. AT OLIVER ST.  
 NEWARK 5, N. J.

**KELNOR**

REG. U. S. PAT. OFF.

*electric* **SOLDERING IRONS**



AMERICA'S  
 FINEST LINE  
 OF LIGHTWEIGHT  
 IRONS

PATENTS  
 GRANTED,  
 APP. FOR

*Designed for  
 most efficient  
 soldering in the*

**ELECTRONIC,  
 RADIO AND  
 INSTRUMENT  
 manufacturing and  
 repairing fields**

Easily solders hard-to-reach connections. Cuts down fatigue, increases accuracy. Illustration above about one-third actual size; weighs 9 ounces. Order from your retailer or jobber.

**KELNOR MANUFACTURING COMPANY**  
 GENERAL OFFICES: CENTRAL TOWER, SAN FRANCISCO 3, CALIF.

*"When Ordering Please Mention Electronics"*



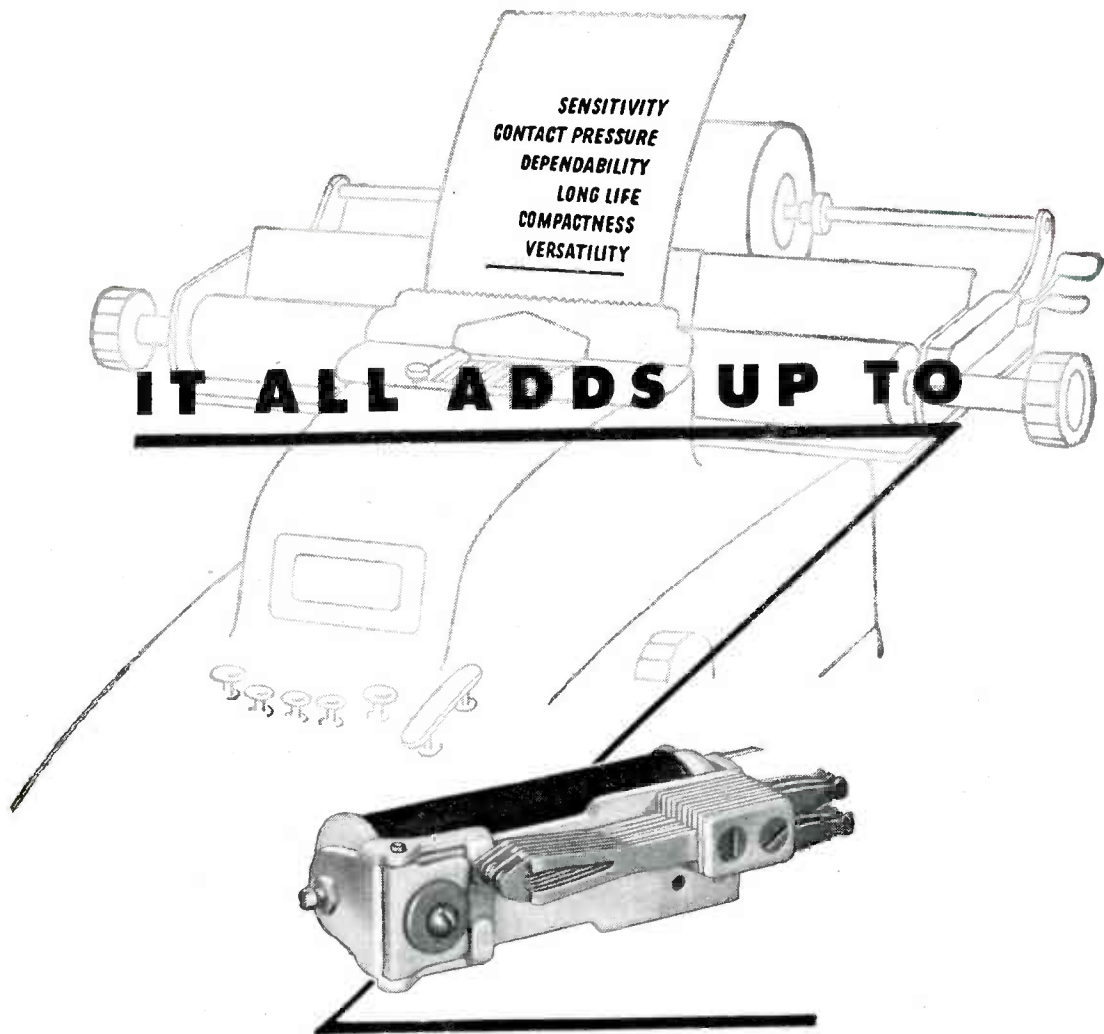

## **AUTOMATIC ELECTRIC'S CLASS "B" RELAY**

All six of the features you want—perfectly combined in one unit—that's what you get in this new relay. It meets all purposes, in widely varied applications, without compromising with the most exacting requirements. For in the Class "B" relay, Automatic Electric has combined the features you need—*all* of them, and each in greatest measure.

*Independent twin contacts for dependable contact closure . . . efficient magnetic circuit for sensitivity and high contact pressure . . . unique armature bearing for long wear under severe conditions . . . compact*

*design for important savings in space and weight. Now available for coil voltages to 300 volts DC and 230 volts AC, with capacities up to 28 springs; also with magnetic shielding cover, when specified.*

The Class "B" relay, and many others, are shown in Catalog 4071. Write today for your copy.

*Relays by*

**AUTOMATIC  ELECTRIC**

**AUTOMATIC ELECTRIC SALES CORPORATION**

1033 WEST VAN BUREN STREET • CHICAGO 7, ILLINOIS

*In Canada: AUTOMATIC ELECTRIC (CANADA LIMITED, TORONTO*

**PARTS AND ASSEMBLIES FOR EVERY ELECTRICAL CONTROL NEED**

# FISHER-PIERCE

## Electronic Relays

### SAVE CONTACT WEAR

- A controlling current of .000006 amperes provides operation of a 2 ampere load on 115 volts 60 cycles.

- A supply circuit (115 volts 60 cycles) furnishes only 3 watts of stand-by power. No power is required from the controlling circuit —

only the closure of a loop to permit the passage of 6 microamperes from an internal 6 volt source. A built-in transformer isolates this controlling circuit from line and ground.

- Load contacts are S.P.D.T. with pilot lamp for 115 volts on the N.O. contact, showing action of the relay even when the cover is closed. Load relay is of the plug-in type, permitting easy change when unusual loads require special load contacts. Conservative design insures extremely long tube life.

- Rugged steel box with hinged cover is fitted with a hanger and equipped with adequate knock-outs.



Model 2212

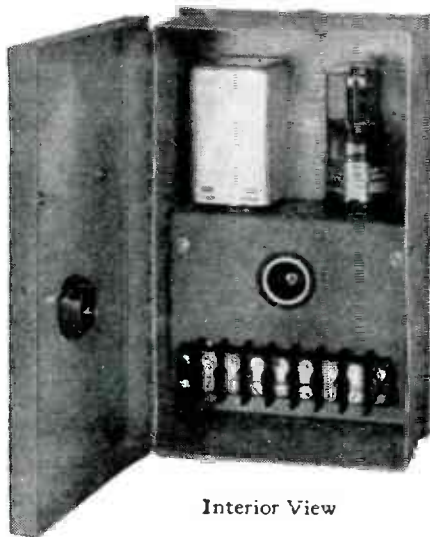

Interior View

Send us your control problem  
and ask for Bulletin 4510



# FISHER-PIERCE

C O M P A N Y

62 CEYLON ST., BOSTON 21, MASS.

increased export business; and in the Echophone line of products including commercial and citizens radio communication equipment.

GOTHARD MFG. Co., Springfield, Ill., is building a modern daylight plant including engineering and research as well as manufacturing facilities for pilot light assemblies.

WOODWARD AND KEEL, Washington, D. C., has been dissolved as a consulting engineering firm. Practice will be continued under the name of John J. Keel at 648 Earle Building, Washington 4, D. C.

SOLAR MFG. CORP., New York, N. Y., purchases a modern factory building at North Bergen, N. J. It is designated as Plant Number 4 and postwar it will become the company's main eastern plant. The company, more than two-thirds of whose prewar production went into radio receiving and transmitting apparatus, expects the postwar ratio to drop to approximately 50 percent radio components with the other 50 percent going into business machines, safety devices, hearing aids, and similar products.

ALLEN B. DUMONT LABORATORIES, Passaic, N. J., have the assignment of a patent by Dr. Thomas T. Goldsmith, covering a system where incoming negative television signals are photographed on positive film by motion picture camera for immediate subsequent projection in theatres.

RAYTHEON MFG. Co., Waltham, Mass. is planning the erection of a television and f-m broadcasting station in Prospect Hill Park, one of the highest points in metropolitan Boston.

CANADIAN MARCONI Co., Montreal, Canada, is supplying a new three-way police radio system to the town of Montreal West. Operating on f-m, the system permits two-way communication between headquarters and cruiser cars and between cars.

SELENIUM CORP. OF AMERICA, Los Angeles, Calif., is the newest member of the Los Angeles Council, West Coast Electronics Manufacturers' Association.

GRENBY MFG. Co., Plainville, Conn. and Allen D. Cardwell Mfg. Corp. Brooklyn, N. Y., consolidate. In-

# DECAL

FULL COLOR NAME PLATES

... for lower cost  
product identification

If your post war product requires identification, trade marking, lubrication instructions, patent or operating data...investigate Meyercord Decalcomania name plates. They're easily, quickly applied at production line speed...to any commercial surface...in any size, colors or design. No screws, rivets or bolts required. Easy to use, lasting adhesives do the job. Meyercord Decals can be made resistant to water, oil, acid, dirt, fumes, temperature extremes...even vibration and abrasion. Address inquiries to Dept. 9-8.

**FREE DESIGNING SERVICE...**

Manufacturers and designers are invited to avail themselves of Meyercord's free designing and technical consultation service on postwar identification problems.



**THE MEYERCORD CO.**

World's Largest Decalcomania Manufacturers

5323 WEST LAKE STREET • • • CHICAGO 44, ILLINOIS

When you think of heated compounds,  
think of STA-WARM equipment for  
heating them.

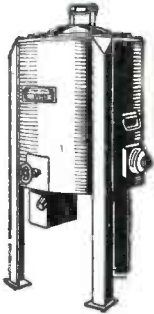

10 gal. (901WV) tank for melting and maintaining pitch, asphalt, waxes, oils, marine glue, chemicals, etc., at any constant temperature in a range up to 550° F.



Light Weight 2 qt. (102L) pot with lip for pouring small amounts of pre-heated compounds.

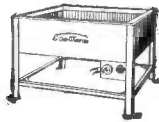

Rectangular tank, with variable thermostat control, in capacities and dimensions to meet your requirements for dipping operations.



10 gal. (901CNV) tank with slow speed agitator and thermostat control, for melting and dispensing heated compounds in varying amounts through needle valve outlet.

Inquire now for general bulletin 036.

**STA-WARM ELECTRIC CO.**  
1000 N. CHESTNUT ST. • RAVENNA, OHIO

**RADEX**

CHICAGO

In future peace-time production, Radex will uphold its war-won reputation by the scope and caliber of its service to the radio and electrical industries.

**Radex Corporation**

53 W. Jackson Blvd., Chicago 4, Ill.

**PRINTERS,  
LAMINATORS,  
FABRICATORS  
OF *Plastics***

INJECTION AND  
EXTRUSION  
MOLDERS

PLASTIC PRINTING by special inks and special methods developed in our plant.

LAMINATION of printed sheets on one or both sides, permanently sealing the printed surfaces.

SHEET FABRICATION on even the most complicated jobs.

Write for Free Booklet E,  
"Hopp Plastics Today & Tomorrow"

**THE HOPP PRESS  
INCORPORATED**

460 W. 34th St., New York 1, N.Y.

**PREMAX**

**"Premax  
Antennas"**

The complete story of Premax Antennas on land, on sea and in the air—with diagrams and illustrations of types in use. Get the new booklet now.

**RADIO  
ANTENNA**

*Premax Products*

**Division Chisholm-Ryder Co., Inc.**  
4502 Highland Ave., Niagara Falls, N. Y.

# is this What You Want?

## But Fast

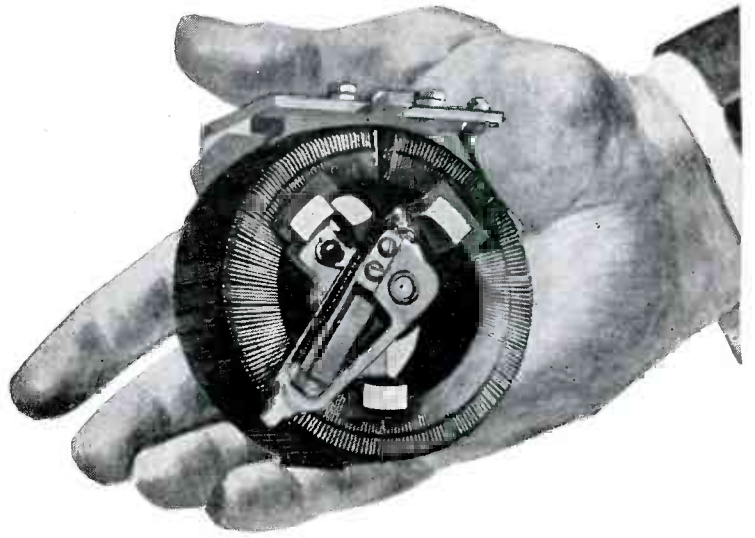

## SORENSEN CAN MEET YOUR DELIVERY DATE ON LIGHT WEIGHT 350-2400 CYCLE VARIABLE VOLTAGE CONTROLS.

**How fast do you need them?** Sorensen & Company takes pride in their record of meeting or beating delivery dates. You name the date — we'll start shipping.

**The single phase 500 V A Variable Voltage Auto Transformer** is designed for an input of 115 volts; output 0-130 volts, 350-2400 cycle, maximum 3.85 amperes, rated 3 amperes. Continuous duty, single phase without air blast cool. With 50 C.F.M. air blast with an ambient of plus 50 degrees centigrade the single phase unit is capable of 1.2 K.V.A. Weight of the single phase unit is 1.85 lbs.

**The three phase 1.5 K.V.A. Variable Voltage Auto Transformer** is designed for an input of 208 volts "Y" connected; output 0-235 volts, 350-2400 cycle maximum 3.85 amperes. Continuous duty, three phase, without air blast cool.

With 100 C.F.M. air blast with an ambient of plus 50 degrees centigrade the three phase unit is capable of 3.5 K.V.A. Weight of the three phase unit is 5.4 lbs.

**The single phase 1.5 K.V.A. Variable Voltage Auto**

**Transformer** is designed for an input of 115 volts; output 0-130 volts, 350-2400 cycle maximum 11.5 amperes, rated 9 amperes. Continuous duty, single phase, without air blast cool.

With 100 C.F.M. air blast with an ambient of plus 50 degrees centigrade the single phase unit is capable of 4.5 K.V.A. Weight of the single phase unit is 3.85 lbs.

**The three phase 4.5 K.V.A. Variable Voltage Auto Transformer** is designed for an input of 208 volts "Y" connected; output 0-235 volts, 350-2400 cycles maximum 11.5 amperes, rated 9 amperes. Continuous duty, three phase, without air blast cool. With 150 C.F.M. air blast with an ambient of plus 50 degrees centigrade the three phase unit is capable of 10 K.V.A. Weight of the three phase unit is 8.9 lbs.

All of the above units were designed for air-borne equipment. They are built with class "B" insulation, a new commutator forming process is employed that eliminates the necessity of reducing copper area on the commutator face.

# SORENSEN & COMPANY

AIRBORNE ELECTRONICS

STAMFORD, CONN.

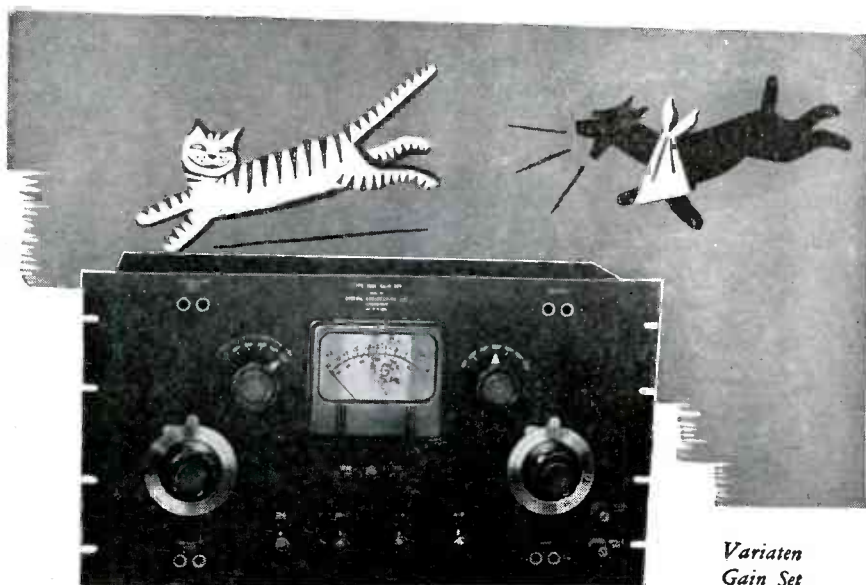

Variaten  
Gain Set  
1901-B

## As necessary to perfect Amplifier performance as the fourth leg to a dog!

You can't have perfect performance in amplifying or other speech transmission without knowing the efficiency and performance of each unit in the installation.

With a Variaten Gain Set you can (1) measure the total amplification of an amplifier; (2) measure the gain at all frequencies to determine whether there is discrimination against any part of the frequency spectrum; (3) measure the power output of any amplifier; (4) measure frequency response of transmission lines in absolute quantities; (5) check all control equipment—in fact, quickly make a quantitative analysis of any part of the audio frequency spectrum.

Unvarying accuracy is all-important. Variaten Gain Set, Type 1901-B (shown above) has a flat frequency characteristic of 0 to 20 kilocycles, and leakage is *guaranteed to be less than 1/10th db.* (Measurements have been made at frequencies as high as 100 kilocycles with practically no error.)

Variaten Gain Set 1901-B is equipped with both send and receive impedance matching controls for *both* Straight T and Balanced H circuits. This dependably accurate instrument can be supplied with either one or two meters.

Write today for complete data on Type 1901-B and other Variaten Gain Sets.

Other Variaten products—*Attenuators, Mixers, Resistors, Matching Pads and other precision sound equipment meet the most exacting specifications. Catalog on request.*



**CINEMA ENGINEERING CO.**  
Established 1935 • Burbank • California

dividual corporate identity and present management will be continued, bringing together complementary engineering, research and manufacturing facilities in both the electronic and mechanical fields.

WIRE RECORDER DEVELOPMENT CORP. is the name of a newly organized offshoot of Armour Research Foundation of Illinois Institute of Technology. The new corporation will take over all commercial functions related to manufacture of wire recorders.

STANDARD ELECTRICAL PRODUCTS Co., Dayton, Ohio, is again engaged in manufacture of transformers, control devices, and relays for airborne radio and radar operation. Full production is expected to commence in a short period.

AIR-TRACK MFG. CORP. is sold by the parent company, F. L. Jacobs Co., Detroit, Mich., to Robert I. Sarbacher and Robert H. Bailey. Manufacture of electronic gear will continue.

### PERSONNEL

ALBERT S. EISENSTEIN gets one of five Frank B. Jewett fellowships for research in physical sciences for the year 1945. Dr. Eisenstein, who is at present a member of the Radiation Laboratory staff at Cambridge, receives a stipend of \$3,000 while a further honorarium goes to the institution where his research is done.

GEORGE L. BEERS is appointed assistant director of engineering in charge of advance development in



the RCA Victor Division of Radio Corp. of America. He was previously on the engineering administrative staff.

GEORGE MILNE is appointed director

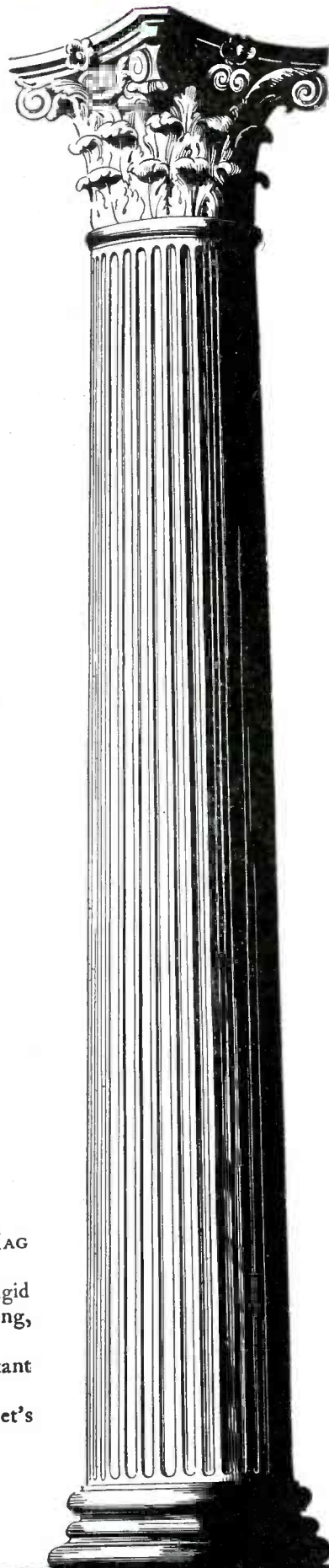

# RIGIDITY

Rigid support and permanence of alignment are provided by ALSiMAG Steatite Ceramics.

These inorganic materials are mechanically strong, permanently rigid and are electrically stable at high frequencies. Do not distort by loading, nor do they shrink or coldflow with time.

ALSiMAG Ceramics are highly resistant to thermal shock and to constant temperatures up to 1000°C. Non-corrodible. Do not absorb moisture.

ALSiMAG Ceramics are a dependable foundation for your design. Let's work together.

**AMERICAN LAVA CORPORATION**  
**CHATTANOOGA 5, TENNESSEE**



*ALCO has been awarded for the fifth time the Army-Navy "E" Award for continued excellence in quantity and quality of essential war production.*

**ALSiMAG**  
TRADE MARK REG. U. S. PAT. OFFICE

**STEATITE CERAMICS**

High Mechanical Strength • Permanent Rigidity  
High Dielectric Strength • Low Loss Factor  
Resistant to High Temperatures  
Will Not Absorb Moisture  
Precision Made of Purest Raw Materials

43RD YEAR OF CERAMIC LEADERSHIP

# NORTON Electrical Instruments

(SHOCK RESISTANT)



SWITCHBOARD  
& PORTABLE

•  
AMMETERS  
VOLTMETERS

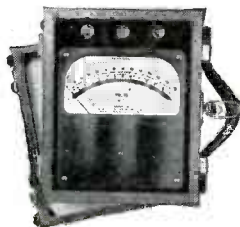

Norton Instruments are precision built to maintain accuracy under exacting conditions. Hand calibrated to meet your specific needs. Widely used in the Electronic Industry for testing and production equipment. Send for complete catalog.

**NORTON Electrical Instrument Co.**  
59 HILLIARD ST., MANCHESTER, CONNECTICUT

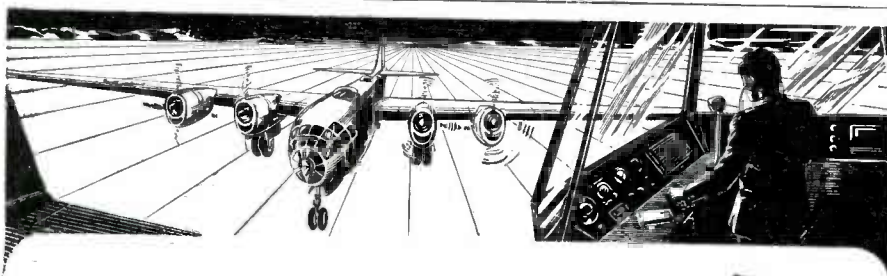

An Invitation to All Electrical Designers to  
**TRY SILVER GRAPHALLOY**

### FOR BRUSHES

High current density, low contact drop, low electrical noise, and self-lubrication are characteristics of this silver-impregnated molded graphite that may be the answer to your electrical brush problems.

SAMPLES of Silver Graphalloy will be gladly furnished for test on your applications. Silver Graphalloy is usually silver plated to permit easy soldering to leaf springs or holders. Why not WRITE NOW for your test samples?

### FOR CONTACTS

Low contact resistance and non-welding when breaking surge currents are inherent properties of this unique combination of conductive silver and self-lubricating graphite



**GRAPHITE METALLIZING CORPORATION**  
1055 NEPPERHAN AVE • YONKERS, NEW YORK



SLIP-RING AND COMMUTATOR BRUSHES AND CONTACTS

# 2 VITAL AIDS

TO THE MANUFACTURER OF  
Miniature Tube Radios

## ★ STAR

DOUBLE-CHECK SYSTEM



#JE-10—Miniature socket wiring plug for accurate alignment of miniature socket contacts during wiring. Precision cast of zinc base alloy—Pins of stainless steel.

#JE-12 — (Hardened tool steel insert) or JE-13 (Stainless steel insert) Miniature tube pin straightener to obtain a perfect fit when the tube is placed in the set.



For complete information and prices—write

RADIO ACCESSORY DIVISION

**STAR EXPANSION PRODUCTS CO.**  
147 Cedar St., New York 6, N. Y.

*"Columbia"*  
is a reliable source

**Immediate Delivery**

LARGEST STOCK OF  
**INSULATED ELECTRICAL WIRE**

No. 22 gauge to No. 12 gauge



**CORD SETS**  
ready-to-attach  
assemblies

**Multi-conductor  
Cords and Cables**

Write for Circular No. 5A

**COLUMBIA WIRE & SUPPLY CO.**  
4110 N. PULASKI ROAD  
CHICAGO 41, ILLINOIS



# PLASTICS INFORMATION

## YOURS...IN THIS CONVENIENT FILE FOLDER



Our handy-reference Folder is designed to be a useful part of your plastics source file. It contains information on the facilities of our organization for plastics engineering, designing, molding and assembly, and includes examples of plastics applications that may have a relationship to your peacetime products. The Folder is free, on request.

Plastics should be reappraised now in the light of improved methods and materials that have been tested in extensive wartime applications. To help you in your consideration of plastics, send for our Folder File. And call on us early in the design stage of your products. This assures the fullest benefit from our molding experience, and the most practical advantages from plastics.



REG. U. S. PAT. OFF.

Write now for Folder File E8



PRECISION MOLDED PARTS

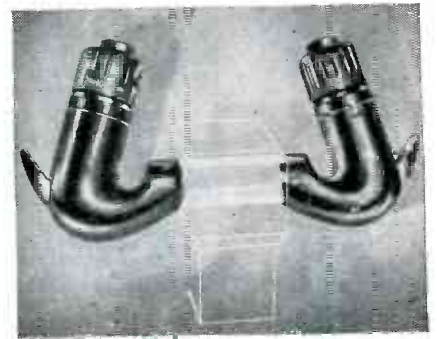

PLASTIC CONTROL GRIPS

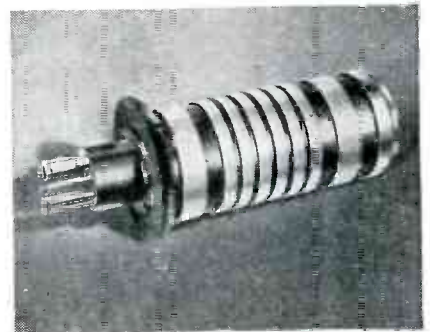

PLASTICS AND METALS COMBINED

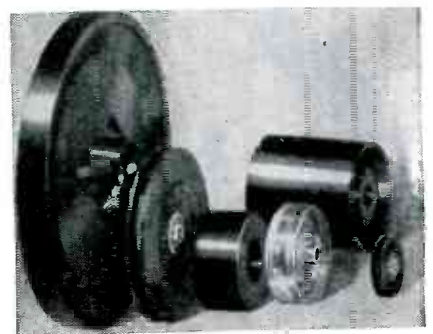

PLASTIC WHEELS for Many Uses

# PLASTIC MANUFACTURERS

INCORPORATED

STAMFORD, CONNECTICUT

MOLD MAKING • INJECTION & TRANSFER MOLDING • COMPLETE ASSEMBLY

Representatives: DETROIT 2-805-06 New Center Bldg. • LOS ANGELES 35-1440 So. Robertson Blvd.

CANADA—A. & M. Accessories Ltd., 19 Melinda Street, Toronto; 1405 Bishop Street, Montreal

*Immediate  
Delivery*

## CO-AXIAL CONNECTORS

FOR  
50 AND 70 OHM LINES

# KINGS

Electronics

MANUFACTURERS OF  
**ELECTRONIC  
EQUIPMENT PARTS**

- **TERMINAL STRIP ASSEMBLIES**
- **ANTENNAE**
- **TRANSMISSION LINES**
- **RADAR ASSEMBLIES**
- **ALIGNMENT TOOLS**
- **SPECIAL EQUIPMENT**
- **WAVE GUIDES**

*For Complete Details  
Write for Catalog.*

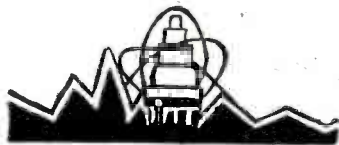

**KINGS ELECTRONICS CO.**

372 CLASSON AVE.  
BROOKLYN 5, N. Y.

of technical operations for the Blue Network of American Broadcasting Co. He was formerly chief engineer.

E. W. D'ARCY goes to the post of chief engineer at DeVry Corp. He was previously research engineer at Essanay Film Corp. and has been with DeVry in a similar capacity since 1940.

C. B. JOLLIFFE, chief engineer of RCA Victor Division, Radio Corp. of America, becomes vice president



in charge of RCA Laboratories. He succeeds to this post Otto S. Schairer who becomes consultant and advisor.

FRANK MARX, former head of the technical advisory group in the Blue Network of American Broadcasting Co. becomes director of general engineering.

N. F. SHOFSTALL is appointed designing engineer of the receiver division in the General Electric Company's electronics department.



He has been serving as chief broadcast receiver engineer, responsible for technical designs of domestic and export broadcast receivers.

J. Z. MILLAR, Colonel, U. S. Army Signal Corps, is appointed radio research engineer for Western Union Telegraph Co., New York, N. Y. He was previously in the electronics division of the same company.

SCOTT HELT is made supervising

# HOW WE SAVE 45 MINUTES OUT OF AN HOUR

When Connecticut Telephone & Electric Division began to make aircraft ignition terminals for a famous engine manufacturer, we knew that standard testing procedure could not keep pace with our mass production methods. Even a score of trained inspectors, each equipped with high-voltage testing equipment, would soon fall hopelessly behind.

Again Great American Industries engineers overcame a stubborn wartime bottleneck. They designed an electro-

mechanical tester which accurately checks four parts faster than former methods could check one. Five such testers, operated by unskilled persons, have a capacity of 12,500 tests an hour... with a degree of error almost too small to measure.

This is but one of many new methods, contributed by G.A.I. engineering to speed the war effort. It will be equally important to efficient electrical manufacturing in time of peace.

## HERE'S HOW IT'S DONE

Operator places terminals to be tested in slots at edge of turntable. As each part reaches test point, one electrode of a 10,500 v. circuit contacts the conductor element of the terminal... while another encircles its insulating shell. Current leakage through minute cracks or porous sections of the insulation operates a relay which ejects the faulty piece. If the terminal meets specifications, it automatically falls into a chute and is conveyed to the packing bench. This swift, foolproof tester lends itself to many production tests of insulation.



**CONNECTICUT TELEPHONE & ELECTRIC DIVISION**  
GREAT AMERICAN INDUSTRIES, INC. • MERIDEN, CONNECTICUT

*Why depend  
on say-so or guessing?  
FOR ABSOLUTE ACCURACY  
get TIME TOTALIZERS!*



FOR an exact record of machine hours the Industrial Time Totalizer provides distinct advantages over written or personal checks. This visible Totalizer will give a record up to 10,000 hours. On equipment of pre-determined life expectancy the Totalizer, by showing the hours in use, visibly signals when replacement ought to be made. Whether your product is now made for the war effort or to compete in postwar markets the application of Industrial Time Totalizers is worth your immediate attention.

**SOME TYPICAL APPLICATIONS**

- Conveyors
- Diesel Generators
- Drill Presses
- Molding Machines
- Oil Burners
- Punch Presses
- Refrigerators
- Radio Transmitters
- Welding Machines
- Vacuum Tube Devices
- and many other types of machines

**INDUSTRIAL TIMER CORPORATION**

110 EDISON PLACE



NEWARK, NEW JERSEY

**Piezo**  
TRADE MARK

**HINGED UNIVERSAL LINK JOINT-TYPE H**  
*Simplifies installation of*  
**REMOTE CONTROLS**

The type "H" hinged Universal Link Joint with solid shafting has three distinct advantages for remote controls. (1) Simplicity of installation (the Universal Link Joint hinges from 0 to 90°). (2) A minimum of backlash. (3) Output shaft turns in exact angular rotation with the input shaft.

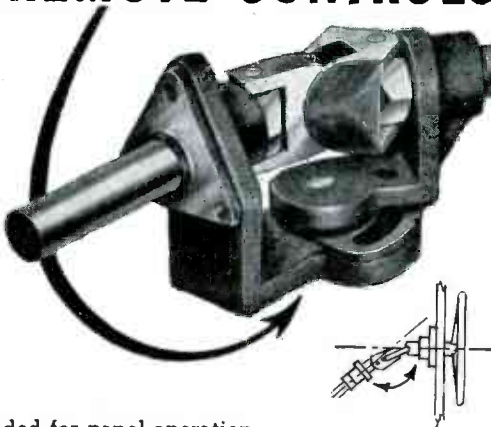

This method is particularly recommended for panel operation of dial and rheostat controls, switches, variable condensers, variable transformers, coils, remote operating rods and other mechanical adjustments.

Write for Bulletin 45B for complete data and specifications.

**PIEZOELECTRIC CORPORATION**

110 EAST 42nd ST., NEW YORK 17, N. Y.



**THERE'S A DRAKE SOLDERING IRON FOR EVERY TYPE OF ELECTRONIC WORK**

From that mighty mite



the Drake No. 400 to the high-speed production "honey"



the Drake No. 600-10 there is a high quality Drake Soldering Iron "just right" for the job.

Drake Heat Controls and the Drake "Magic Cup" Stand are important soldering aids.



SEE  
YOUR RADIO  
PARTS JOBBER

**DRAKE ELECTRIC WORKS, INC.**  
3656 LINCOLN AVE. CHICAGO, ILL.

**DKE CAPS AND BASES**

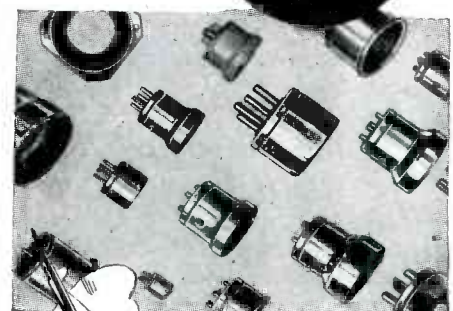

*..for precision application!*

Dependable DKE electronic tube components are used extensively by many of the leading manufacturers. A wide variety of standard designs are available, with exceptional economies resulting from complete DKE tooling facilities. Special bases, caps and clips can be produced to exacting specifications on short notice with low unit cost.

INQUIRIES INVITED

**THE ENGINEERING CO.**

DANIEL KONDAKJIAN  
27 WRIGHT ST., NEWARK, N. J.

**FOR SPEEDY ASSEMBLY  
ON THE PRODUCTION LINE—**



**FOR SPEEDY MAINTENANCE  
IN THE FIELD**



# IT'S THE AMP SPlicing TERMINAL

**USE THROUGHOUT IN THE MANUFACTURE OF WIRING SYSTEMS; HARNESES, COMPONENTS, ETC.**

### ASSEMBLY LINE ECONOMY

The AMP Knife-Disconnect Splicing Terminal is easy to put into an assembly line, for no skill is required even by untrained workers to install AMP solderless terminals. (Many plants are already set up and are producing new equipment using these modern quick disconnect terminals, thereby eliminating retraining of workers to unfamiliar obsolete methods.)

THE AMP Splicing Terminal uses identical ends, perfectly engaged. Just crimp the AMP Splicing Terminal on the wire and it's ready to be attached to any other AMP Splicing Terminal or similarly designed AMP integral stamping. When the two identical

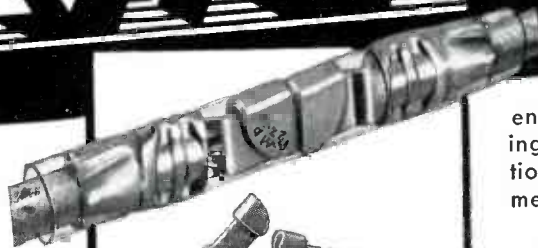

ONLY 2 PARTS!  
BOTH IDENTICAL



QUICK POSITIVE SPlice, STAYS TOGETHER  
UNTIL INTENTIONALLY TAKEN APART

**NO SOLDER!**

ends are engaged, slip insulation sleeving over the joint and you've a connection giving maximum electrical and mechanical performance.

### QUICK CONNECTION AND DISCONNECTION FOR MAINTENANCE

There is no need to remove equipment housings, unscrew binding posts, or cut wires to remove or repair equipment—merely place AMP Knife-Disconnect Splicing Terminals at the right spots for easy servicing. Then it is a simple matter to disconnect the wire or wires and lift out the part or work on a cold circuit. Here is maintenance lowered to its irreducible minimum.

Design quick disconnection into electrical equipment with the AMP Splicing Terminal. It works for you all the way down to the service man.

Write today for samples of AMP Splicing Terminals—wire sizes from 22 to 8 inclusive.

SEND FOR BULLETIN 31A

**ONE SPlice END TO THE WIRE**



TERMINALS WITH OR WITHOUT INSULATION SUPPORT  
PRE-INSULATION OR CORROSION PROOFING



**THE OTHER A PART OF THE EQUIPMENT**

THIS END MAY BE AN ADAPTOR PART OR  
AN INTEGRAL PART OF THE EQUIPMENT

# AMP

**AIRCRAFT-MARINE PRODUCTS INC.**  
1521-53 NORTH FOURTH ST., HARRISBURG, PENNA.

In Canada: David C. Orrock, 1405 Bishop St., Montreal, Quebec; F. N. Adams, 726 Homer St., Vancouver, British Columbia

In Vacuum Gauges . . . its the new

# Alphatron

No. 3 in series on new developments in the field of High Vacuum

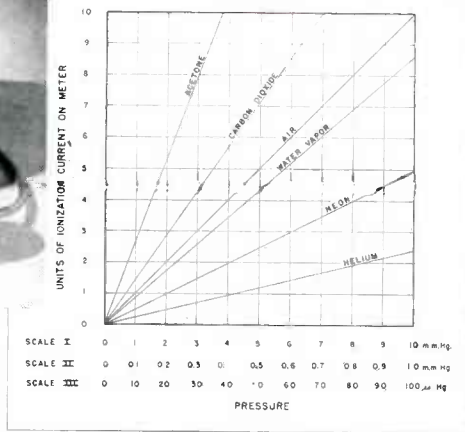
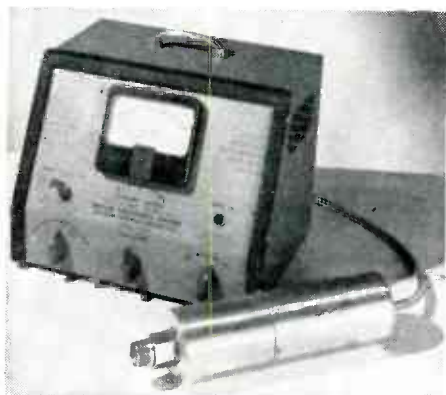

Alphatron Gauge Type 510 Preliminary Calibration Scale

**1 micron to 10 millimeters** . A single gauge giving continuous linear indication of pressure in three ranges: 1-100 microns; 1-1000 microns and 1-10 millimeters.

**instantaneous response** . The Alphatron utilizes the ionization effect of alpha particles. This new principle enables instantaneous response to pressure change and thus avoids lag in readings.

**undamaged by atmospheric pressure** . . . . . The flow of alpha particles is produced from a sealed radium source. There is no filament to burn out, and the gauge is unaffected by exposure to atmospheric pressure.

**simple calibration for different gases** . . . . . The graph above shows that the Alphatron has linear reactions to pressure throughout its entire range. Calibrated for dry air the standard Alphatron may be used directly for other gases by means of calibration factors. Excellent for use with systems containing water vapor and for leak detecting.

**specifications** . . . . . Control box: size 12 $\frac{5}{8}$ " x 9 $\frac{1}{4}$ " x 9 $\frac{3}{8}$ ", weight 20 lbs., finish grey and black crackle with red trim; gauge (including first stage amplifier); size, 12" x 3" O. D., weight 5 lbs., finish natural; cables: 10 feet special 10 conductor; power 110 volts, 60 cycle, A. C., 1 ampere; calibration as shipped: dry air; shipping weight; approximately 27 lbs.

**Vacuum**  
ENGINEERING DIVISION

**NATIONAL RESEARCH CORPORATION**  
BOSTON 15, MASSACHUSETTS, U.S.A.

*High Vacuum for Industry*

For full particulars send for bulletin G-3.

engineer for Studio A at the Du Mont television station, WABD, New York, N. Y.

DR. LORENZO EMO, specialist in artificial radioactivity, joins the staff of Battelle Memorial Institute, Columbus, Ohio, where he will be engaged in research on industrial physics.

DON C. MCRAE returns to Eastern Air Lines as superintendent of communications. He has been serving with the Armed Forces since May, 1942.

PAUL DE MARS, still on active duty as lieutenant commander in the Navy, joins the consulting firm of



Raymond M. Wilmotte. He will ultimately be identified with a new department for industrial electronics within the firm.

DANIEL W. GELLERUP returns to the staff of the Milwaukee Journal Radio Stations, WTMJ and WMFM as broadcast technical supervisor. He has been on leave to the National Defense Research Council, Columbia University, assigned to the Bureau of Ships, U. S. Navy.

E. N. WENDELL, long-time member of the engineering staff at International Telephone & Telegraph Corp., New York, N. Y. takes charge of the radio division of Federal Telephone & Radio Corp. Among his former activities was the development of instrument landing systems for CAA.

JACK DAVIS becomes chief engineer of the auto radio division, Galvin Mfg. Corp., Chicago, Ill.



# WHEN AMERICA TURNS TO POSTWAR PRODUCTS

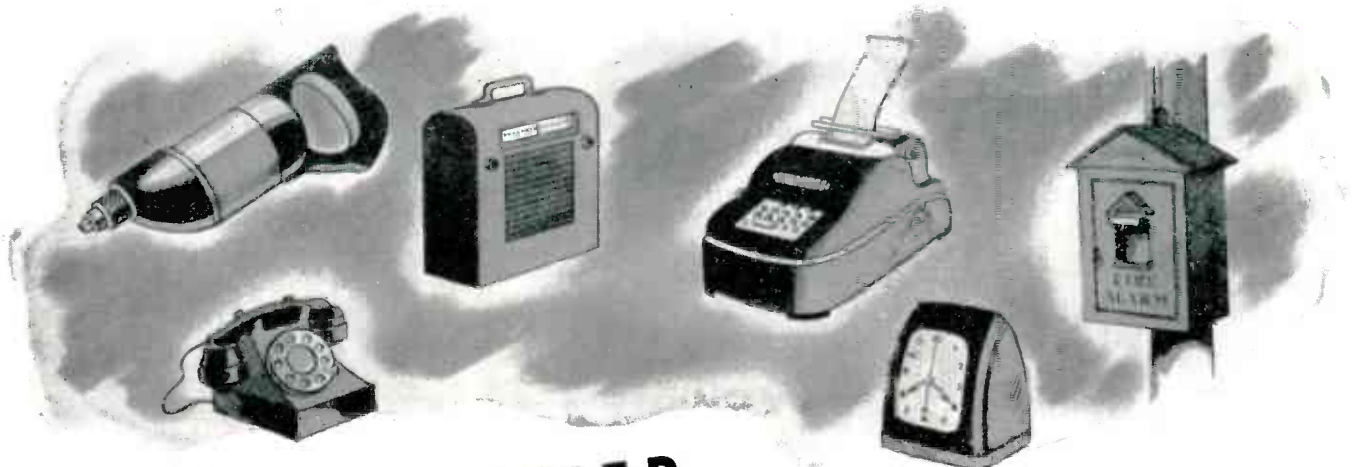

## A RECTIFIER MAY MEAN THE DIFFERENCE...

... Success or failure of many postwar products will depend on the correct selection of a d-c power unit. For most low-voltage d-c applications a copper-oxide, a selenium or a Tungar rectifier are the units most frequently used. G.E. and only G.E. builds all three. Each performs best when doing the job for which it was specifically designed.

When selecting a rectifier, construction, basic materials, weight, size, cost and life expectancy are all factors that must be considered. The conditions under which a rectifier is to operate and the results that are to be obtained determine which type will do the most economical, most efficient and most satisfactory job.

If you are in the market for a rectifier, choose the correct size and type from the G-E line. There's a size and type for every d-c application. If you need help in making your selection, let G-E engineers assist you. Years of experience qualify them to recommend the rectifier which will give you the most profitable performance. Whether they recommend copper-oxide, selenium or Tungar you can be sure their selection is impartial.

For more information write to Section A854-119, Appliance and Merchandise Department, General Electric Co., Bridgeport, Conn.

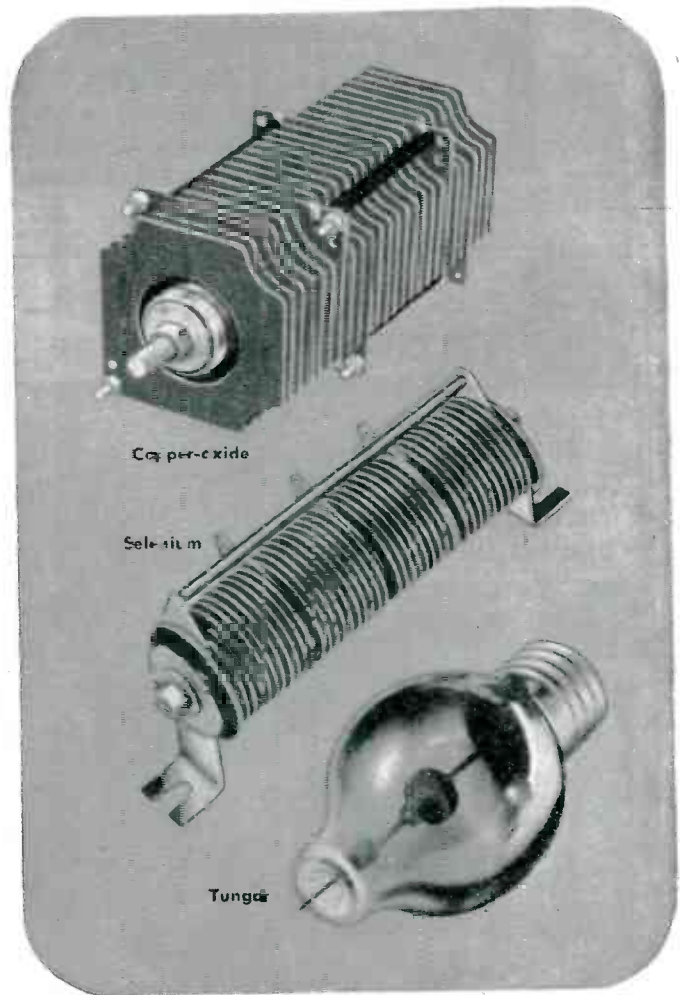

Copper-oxide

Selenium

Tungar

# GENERAL ELECTRIC

Hear the General Electric radio programs: "The G-E All Girl Orchestra" Sunday 10 P.M. EWT, NBC. "The World Today" news every weekday 6:45 P.M. EWT, CBS. "The G-E House Party" Monday through Friday 4:00 P.M. EWT, CBS.

**BUY WAR BONDS AND KEEP THEM**

**NEED SMALL, INTRICATE  
METAL STAMPINGS  
TO CLOSE TOLERANCES?**

**GOAT** *Precise-Formed*  
**METAL STAMPINGS**

**HOW GOAT SAVES YOU  
TIME AND MONEY**

Goat specializes in the design and fabrication to close tolerances of small, intricate, drawn, formed, stamped metal and alloy parts. Expert tool design, quality control, and modern manufacturing techniques can save you time and money on parts like those illustrated above.

ENGINEERS  
SEND US  
YOUR  
PROBLEMS



**GOAT** METAL STAMPINGS, INC.  
AN AFFILIATE OF THE FRED GOAT CO., INC.  
314 DEAN STREET, BROOKLYN 17, N. Y.



**adeco...**

**NOZZLE TESTER**  
*Keeps Diesel Engines  
Running Efficiently*

To keep diesel engines operating at peak efficiency, this portable, precision-built Adeco Nozzle Tester is indispensable.

Light in weight yet built for heavy-duty service, it enables any mechanic to make quick accurate tests on injector opening pressure, spray pattern, etc., and detect stuck needle valves and leakage around valve seats. Tests both large and small injectors, on bench or engine, at pressures up to 10,000 p.s.i. Prevents costly delays and possible damage to engine.

Ideal for testing hydraulic devices.



Write for bulletin on this practical, low-cost unit.

**TESTS FUEL INJECTORS  
AND HYDRAULIC DEVICES**  
at Pressures up to 10,000 p.s.i.



**AIRCRAFT & DIESEL  
EQUIPMENT CORP.**

DEPT. J6: 4411 N. RAVENSWOOD AVE.  
CHICAGO 40, ILLINOIS



*Hercules*  
**TRANSFORMERS and COILS**

Standard and  
CUSTOM  
CONSTRUCTION  
to meet all  
specifications

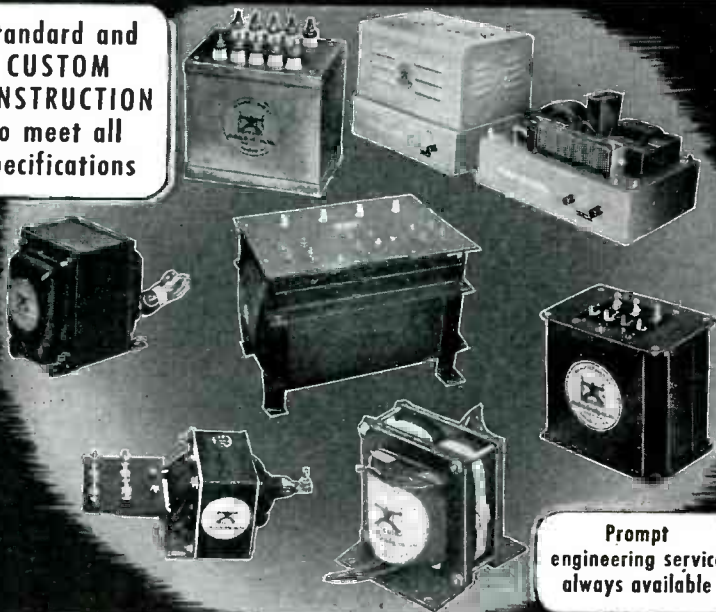

Prompt  
engineering service  
always available

**HERCULES ELECTRIC & MFG. CO.**

INCORPORATED  
2500 ATLANTIC AVENUE • BROOKLYN 7, N. Y.

DC and AC WELDERS • TRANSFORMERS • MAGNETIC CLAMPS • SOLENOIDS • RIVET HEATERS  
SPOT WELDERS • FLUORESCENT BALLASTS • SPECIAL CONTROLS



# MALLORY VIBRAPACK \*

## Provides Dependable Plate Power for Portable Electronic Equipment

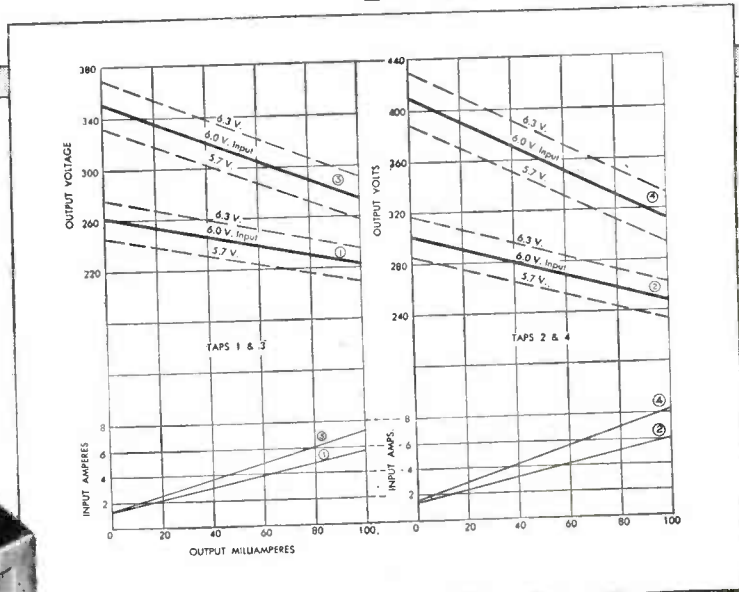
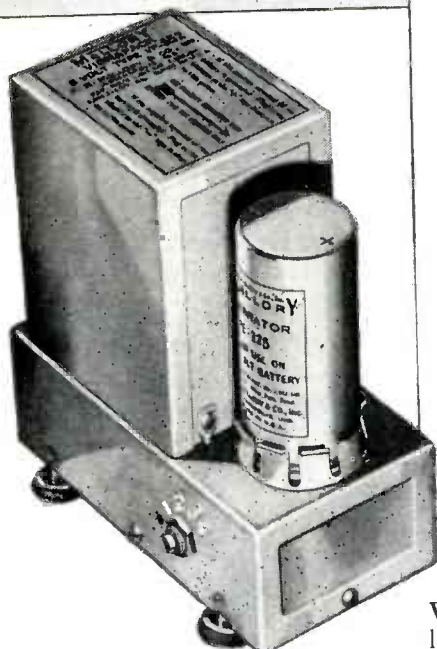

Operating characteristics of Mallory Vibrapack VP-552

Wherever dependable high voltage is required from a low voltage DC source, Vibrapacks\* are built to deliver plate power efficiently and economically over a long life. Vibrapacks are used successfully in operating radio receivers, transmitters, PA systems, direction finders and other electronic apparatus on police cars, aircraft, automobiles, farms, boats, in military, naval, forestry and lighthouse service . . . wherever a source of commercial AC is not available.

**Features of Mallory Standard Vibrapacks include:**

Nominal input voltages of 6, 12 and 32 volts DC.

Nominal output voltages from 125 to 400.

Models available with switch for four output voltages in approximate 25-volt steps.

All standard Vibrapacks are equipped with new Mallory Hermetically-Sealed Vibrators for top performance in extremes of atmospheric pressure or humidity.

Heavy-duty Vibrapacks are available that will deliver up to 60 watts power. You can obtain Mallory Vibrators and Vibrapacks at your nearest Mallory Distributor. Ask him for literature, or write us today.

*Inquiries are invited from manufacturers for Vibrators and Vibrapacks for use in original equipment.*

**P. R. MALLORY & CO., Inc., INDIANAPOLIS 6, INDIANA**

\*Reg. U. S. Pat. Off.



**P. R. MALLORY & CO. Inc.**  
**MALLORY**

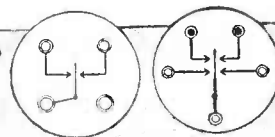
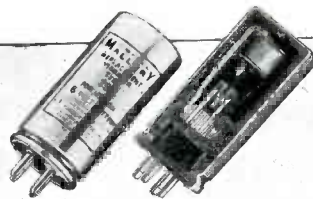

**VIBRATORS**  
**and VIBRATOR POWER SUPPLIES**

# NEW PRODUCTS

Month after month, manufacturers develop new materials, new components, new assemblies, new measuring equipment; issue new technical bulletins, and new catalogs

## Vacuum Tube Frequency Meter

MODEL 39-VTF vacuum tube frequency meter is manufactured by J-B-T Instruments, Inc., 441 Chapel St., New Haven 8, Conn., and is designed to provide the maximum degree of accuracy in measuring frequencies located in the 400, 800, 1200, 1600, 2400 and 3600-cycle bands. A special multivibrator circuit in the unit divides the incoming frequency by 2, 3, 4, 6 and 9. The resulting frequency is measured by a standard vibrating reed frequency meter. Measurements in the above-mentioned bands are

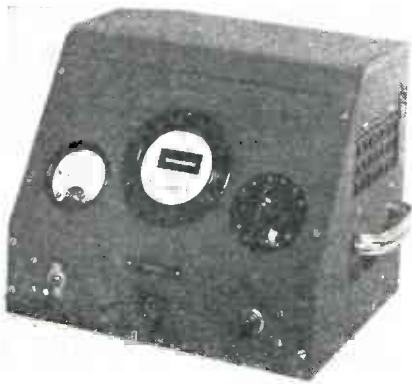

rated 0.25 percent accuracy or better, independent of line voltage. This accuracy is maintained and no calibration or standardization is ever required. No initial stabilization period is required, and no protection is needed against accidental frequencies above the range being measured. Characteristics of Series A of this instrument are: Frequency ranges: Basic range 380-420 cycles. Multiplier switch permits use in ranges of 2, 3, 4, 6 and 9 times the fundamental range; input sensitivity 500,000 ohms; voltage range 100-350 volts; power consumption approximately 25 watts at 115 volts, 60 cycles; tubes used

include 2-6N7 multivibrators, 1-6N7 input, 1-6J5 buffer, 1-6V6 amplifier, and 1-6X5 rectifier. The unit is housed in an 8 x 10 x 8 cabinet with a sloping panel.

## Positioner

A SERVO-OPERATED variable voltage transformer, manufactured by Superior Electric Co., Bristol, Conn., was developed to fill the need for accurately controlling the plate power to a number of preset levels in dielectric heating apparatus. In this application it was desired to use an r-f generator to heat in sequence a number of mold preforms, each requiring a different power level. A control circuit is alternately connected to one of four controls which causes the output voltage of a motor-operated Powerstat variable transformer to increase from zero to a voltage indicated by the control dial. Connection to another control or resetting of the control in the circuit causes a corresponding change to take place in the Powerstat output voltage. The circuit is arranged so that this change of voltage is accomplished either by reducing to zero voltage and in-

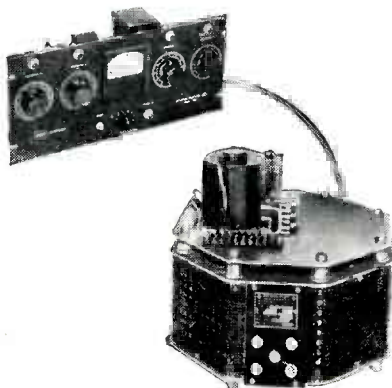

creasing to the new value or by continuous change to the new value without reducing to zero.

The apparatus consists of a motor-operated Powerstat variable transformer and remote positioning elements which are bridge connected. The output of this bridge is connected to a thyatron relay assembly which energizes the Powerstat driving motor until balance is reached.

Any Powerstat variable-voltage transformer from  $\frac{1}{2}$  to 100 kva may operate with this Seco remote positioner.

## Frequency Compensated Instruments

WESTON ELECTRICAL Instrument Corp., of 617 Frelinghuysen Ave., Newark 5, N. J. announces that their a-c electrical measuring instruments can now be furnished with special forms of compensation

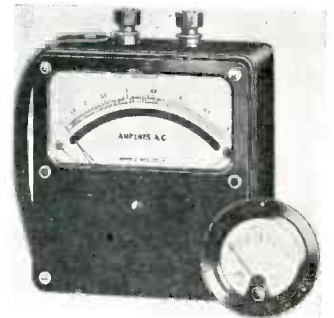

to maintain their accuracy over frequency ranges of from 25 to 3000 cycles. Instruments are furnished as ammeters, voltmeters and wattmeters in both the portable and switchboard types, flat compensated up to 1000, 2000 and 3000 cycles.

## Crystal Unit

BLILEY ELECTRIC Co., Erie, Pa., announces a new low-frequency crystal unit (designated FM-6) that will maintain its frequency within narrow limits. The equipment utilizes a resonant pin assembly. The steel pins are mechanically resonant to the crystal frequency or some multiple of that frequency so that any damping effect of the clamping pins is negligible. The internal assembly is protected against moisture and humidity by means of

# Anyway you look at them...

## THEY'RE GREAT LITTLE METERS!



Side View

Front, side or back — inside and out — the 1½" Round Model 120 can do a whale of a job for you on a wide variety of applications.

External pivots provide maximum accuracy in mounting the moving element between the jewel bearings ... prevent rocking of pointer ... reduce side friction between jewels and pivots ... increase the life of bearing surfaces. Movements are designed to meet forthcoming JAN-I-6 specifications for 1½ inch instruments.

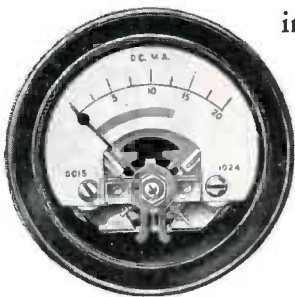

Front View



Back View

Model 112 has all the features of the Model 120 except that it has a square, bakelite case. Like the 120 it is available either as a D.C. or A.C. (rectifier) instrument. Write for latest catalog.

Built with fine precision, entirely self-contained ... with built-in resistors and shunts, this great little meter is also completely immersion-proof throughout. It has a special locking device for exerting pressure against rubber gaskets on either side of the glass. Watertight sealing includes terminal studs and a gasket back of the flange waterproofs the juncture between the meter and the panel. Installation is easy — a ring mounting eliminates mounting screws. The case is Black Anodized Aluminum.



"Inside" View

BUY WAR BONDS



# DeJUR - AMSCO CORPORATION

GENERAL OFFICE: NORTHERN BLVD. AT 45th STREET, LONG ISLAND CITY 1, N. Y.

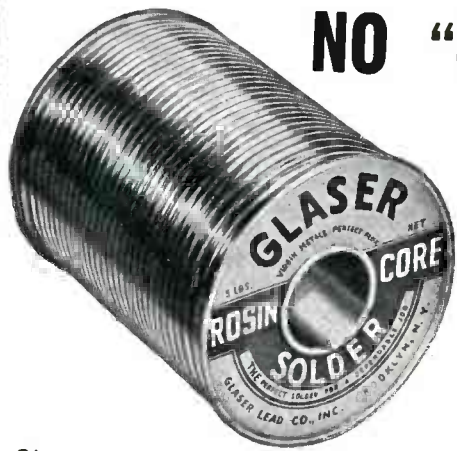

**NO "COMEBACKS"**  
when you use

**Glaser**  
**SOLDER PRODUCTS**

Glaser Rosin Core Solders exceed Government specifications in purity, and are guaranteed to meet A.S.T.M. Class A specifications for solder.

YOU can't take chances with soldering connections in the electronic and radio fields. *The bonding must be permanent.*

When you use Glaser Solders and Fluxes you are protected against "comebacks." *Glaser soldering jobs stay put!*

Glaser Solder Products and Fluxes are dependable because they are produced under rigid scientific control. Their quality never varies, insuring uniform performance. Glaser Products have served American industries for over 23 years. Our engineering Department knows what each must be—for every purpose—to perform perfectly under severest service conditions.

The outstanding quality of Glaser Products is well known in the electronic and radio industries. Widely used in the manufacture of delicate electrical equipment for the Signal Corps and other branches of the Military Service.



Write for literature

GLASER LEAD CO., INC., 31 WYCKOFF AVE., BROOKLYN 27, N. Y.



**METAL STAMPINGS**  
IN SMALL LOTS

Die cut metal stampings in limited quantities can be produced to your special requirements at 15% to 20% of the cost of permanent type tools. No matter how small your quantity requirements or how intricate your work, we can show you a definite saving. During our twenty-three years of specialized experience in this service, there has been no other method of producing metal stampings in small lots that can equal the process originated by Dayton Rogers.

Our new, illustrated booklet #176-17 will give you full particulars.

**DAYTON ROGERS MFG. CO.** 2835 12th Avenue So. Minneapolis, Minnesota

**ENGINEERING EXPERIENCE and Manufacturing Facilities for**

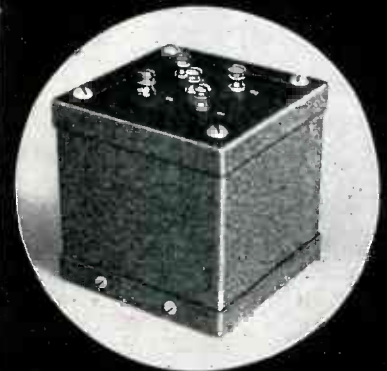

**FILAMENT TRANSFORMERS**



**MODULATION TRANSFORMERS**



**REACTORS**

**SEND PRINTS AND SPECIFICATIONS IN CONFIDENCE FOR ESTIMATE**

**THE ACME ELECTRIC & MFG. CO.**  
CUBA, NEW YORK • CLYDE, NEW YORK

**Acme Electric**  
TRANSFORMERS

# Get Out From Behind



## 8 causes of wire-failure

### A Few Typical Rockbestos Constructions that assure long-lasting, dependable Performance:

#### ROCKBESTOS FIREWALL RADIO HOOKUP WIRE

The first lightweight, small diameter, flame-resistant hookup wire designed in 1937 and widely used since in airborne and ground communications systems, electronic devices, instruments and apparatus. Operating temperature ranges from 125° C. to minus 50° C. Also with tinned copper shielding braid and in twisted pair or tripled construction. Sizes No. 22 to 4 AWG in 1000 volt rating, and No. 12, 14, 16 AWG in 3000 volt.

#### ROCKBESTOS TYPE CA LEAD WIRE

Has high dielectric strength and moisture resistance for use where heat and humidity are encountered. No. 20 to 8 AWG solid or stranded copper, monel or nickel conductors insulated with synthetic tape and various thicknesses of felted asbestos finished in black, white or colors for coding purposes. Also with All-Asbestos insulation only, where high moisture resistance is not required.

#### ROCKBESTOS THERMOSTAT CONTROL WIRE

A multi-conductor control wire for low voltage intercommunicating, signal and temperature control systems. Its life-time heatproof and fireproof insulation and rugged abrasion-resisting steel armor will give you trouble-proof circuits. Sizes No. 14, 16 and 18 AWG in two to six conductors with .0125", .025" or (for 115 volt service) .031" of felted asbestos insulation and steel armor.

#### ROCKBESTOS A.V.C. 600 VOLT MOTOR LEAD CABLE

(National Electrical Code, Type AVA—max. operating temp. 110° C.)

Heatproof, fireproof, greaseproof and oilproof, this cable will not dry out and crack, won't burn or carry flame, and will remain permanently flexible. For coil connections, motor and transformer leads where overloads, extreme heat and fire hazards are encountered. Sizes No. 18 AWG to 1,000,000 CM insulated with two walls of felted asbestos and a high-dielectric varnished cambic insert, with a heavy asbestos braid overall.

A few of the 125 different wires, cables, and cords designed for severe or unusual operating conditions by Rockbestos.

1. High ambient temperatures
2. Aging and ozone oxidation
3. Moisture, alkalis, solvents
4. Conductor-heating overloads
5. High operating temperatures
6. Oil, grease, corrosive fumes
7. Arc fires and external flame
8. Cracking caused by vibration

One of the easiest low-cost methods of keeping 'on the ball' in the race for product acceptance is to give a little extra consideration to the selection of the *correct* wire for your particular application. Don't pick it by size, rating, appearance and price—insist on *lasting performance* under any and all conditions and you'll build a reputation for dependability that will bring increased sales.

A little wire can make your product look pretty bad if it fails to stand up in service, and savings of a few cents or dollars won't mean much if your customers aren't satisfied. A few avoidable trouble-starters are mentioned above—others not to be overlooked are excess voltage drop, inadequate current carrying capacity, and the burrs and tight bends that may abrade the insulation during installation.

Let us help you protect your product's performance with *permanently insulated* wires, cables and cords resistant to heat, flame, moisture, oil, grease, corrosive fumes or alkalis. 125 different constructions to select from—and Rockbestos Research will gladly work up a "special" to meet your *specific* requirements if a standard won't do. For engineering assistance and samples, write the nearest district office or:

**ROCKBESTOS PRODUCTS CORPORATION**  
426 NICOLL STREET, NEW HAVEN 4, CONN.



## ROCKBESTOS RESEARCH Solves Difficult Wiring Problems

**For Victory—Buy War Bonds!**

NEW YORK BUFFALO CLEVELAND CHICAGO PITTSBURGH ST. LOUIS LOS ANGELES SAN FRANCISCO SEATTLE PORTLAND, ORE.

# GET THE HELP OF EXPERTS ON SHOP TOOLS & EQUIPMENT

SHOP and tool room problems can be solved with utmost speed and efficiency with the aid of W-J production engineers. This staff of long experienced experts is qualified to advise you not only on standard methods and machinery but also on remarkable new techniques and equipment. Among a long list of fine production items, W-J has in stock ready for immediate delivery such products as Dic-less duplicating tools, drills, blowers, saws, grinders, shop boxes, tool tenders, and many wonder-working electronic devices. Let us demonstrate their application, or mail the coupon for detailed information.



SEND FOR THIS NEW BUYER'S GUIDE

Please mail me copies of your Shop Tool and Equipment brochure and new catalog.

NAME \_\_\_\_\_  
 COMPANY \_\_\_\_\_  
 CITY \_\_\_\_\_ ZONE \_\_\_\_\_ STATE \_\_\_\_\_

**WALKER-JIMIESON, INC.**

311 SOUTH WESTERN AVE., CHICAGO 12, ILL.

Phone CANal 2525



a captive gasket seal. The unit is designed for such applications as frequency standards, timers, measuring equipment, frequency meters, carrier current and other applications where an accurate source of low frequency is required.

## Calculator

ALLIED RADIO Corp., 833 W. Jackson Blvd., Chicago 7, Ill., has released a new parallel-resistance and series-capacitance calculator which is essentially a slide-rule device, designed to provide a rapid and ac-

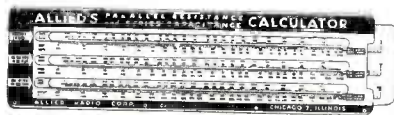

curate means of determining the reciprocal of the sum of two reciprocals as expressed by the formula  $1/x = 1/a + 1/b$ . A single setting of the slide automatically aligns all pairs of  $a$  and  $b$  values which will satisfy the equation for any given value of  $x$ . The calculator indicates the numerous pairs of resistors which may be connected in parallel, or capacitors in series to provide any required resistance or capacitance value. It is priced at 25 cents.

## Voltage Control Unit

SUPERIOR ELECTRIC Co., Bristol, Conn. announces a new, compact and portable source of variable a-c voltage, designated as Voltbox. By



simply connecting the unit to a single-phase outlet, an output variable from zero to above line voltage can be obtained. Accurate voltage

# USE G-E



# SAFETY SPARK GAPS

## For Protection Against High-voltage Surges

G-E Safety Spark Gaps protect condensers against high voltage surges. These spark gaps are of the metal-to-glass sealed gas-filled type. They are calibrated on 60-cycle a-c peak.

Voltage spread between first trace of breakdown and complete breakdown is held to a minimum value for a wide range of rise times. Ratings are for ambient temperatures of 75° to 95° F. Breakdown voltage decreases with lower temperature and increases with higher temperature one to two volts per degree.

G-E Spark Gap ratings are 500-volts  $\pm 20$  per cent, also 1200- and 2200-volts  $\pm 10$  per cent.

Do you have an application for G-E Safety Spark Gaps? For additional information write to Section Q-856-119, Appliance and Merchandise Dept., General Electric Company, Bridgeport, Conn.

**GENERAL ELECTRIC**



**Make them anywhere you like...**

## **BRUNING Black and White Prints!**

• No special room—no special set-up—is needed to make these easier-to-read Bruning Black and White Prints. With the Bruning 75-159-B Volumatic Printer Developer, for instance, you can make BW Prints in your drafting room—engineering department—or private office. No plumbing—because BW Prints require no washing and are delivered ready for use.

Bruning BW Prints give you *exact* positive reproductions of your tracings—black on white. That's why notes and corrections show up so much more clearly on a BW Print than on a blue print... why BW Prints save time and trouble in reading and checking. Remember, there is up-to-date Bruning Printing and Developing equipment for *every need*—no matter how large or how small the quantity of prints you produce. Send for our free new booklet showing how and why BW Prints can save you time and money.

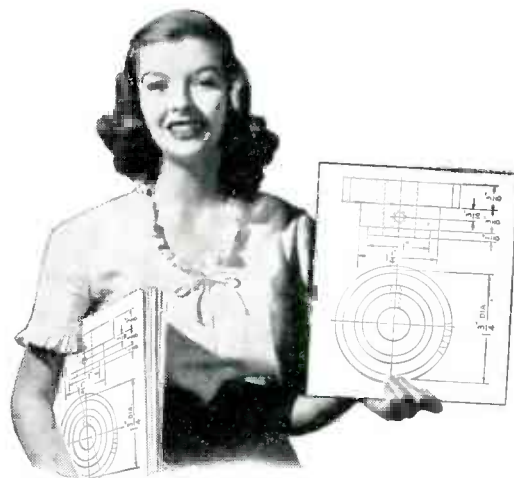

*On the 75-159-B Volumatic Printer-Developer, BW Prints can be made on sheets cut to the exact size of your tracings to save trimming and waste, or from roll stock if you prefer. A BW machine is available also for large-volume roll stock production. The BW process is clean—noiseless—odorless. Even inexperienced persons quickly learn to make BW Prints.*

### **CHARLES BRUNING COMPANY, INC.**

*Since 1897*

**NEW YORK**

Atlanta  
Kansas City  
St. Louis

**CHICAGO**

Boston  
Milwaukee  
San Francisco

**LOS ANGELES**

Detroit  
Newark  
Seattle

Houston  
Pittsburgh

CHARLES BRUNING COMPANY, INC.,  
4712-20 Montrose Avenue, Chicago 41, Illinois

Please send me your free booklet giving up-to-date information on Bruning Black and White Prints. I understand there is no obligation.

Name

Address

City  State

Designed for



Application

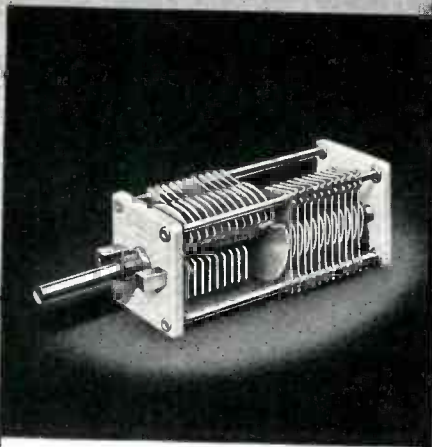

### The 28000-29000 Series Variable Air Capacitors

"Designed for Application," double bearings, steatite end plates, cadmium or silver plated brass plates. Single or double section .022" or .066" air gap. End plate size: 1 9/16" x 1 11/16". Rotor plate radius: 3/4". Shaft lock, rear shaft extension, special mounting brackets, etc., to meet your requirements. The 28000 series has semi-circular rotor plate shape. The 29000 series has approximately straight frequency line rotor plate shape.

## JAMES MILLEN MFG. CO., INC.

MAIN OFFICE AND FACTORY  
MALDEN  
MASSACHUSETTS



setting to 1 percent is assured by an easily read voltmeter displayed on the face of the Voltbox. Overloading is prevented by the use of a circuit breaker which also serves as an "on-off" switch. Model U-1000 (the letter U designates unregulated) operates from a 115-volt line to deliver an output variable from zero to 135 volts at 7.5 amp, while Model U-800 has twice the voltage rating and an output current of 3.0 amp. For line voltages which fluctuate to the extent that it is impossible to set and hold the voltage to a prescribed value, regulated Voltboxes (Type R-500) are available. This unit is similar to the unregulated types except that a voltage stabilizer is included in the unit. R-500 operates on 115-volt lines with a maximum output of 500 va.

### Universal Meter Scales

"HC" UNIVERSAL meter scales are used when converting 0-1 milliamp or more sensitive meters into multi-meters reading a-c or d-c volts, ohms from one hundredth of an ohm to infinity and milliamperes in a sufficient number of ranges to satisfy any electrical measurement purpose. These scales are reproductions of individual precision calibrations and are made in four types for each of three different meters: Weston (Model 301), Jewell (Pattern 88) and Triplett (Model 321), making 12 different scales in all. They are reproduced on white and platinum Bristol board. Plain milliammeter scales, made only for Weston Model 301 meters, are available in the following ranges: 0-25, 0.50, 0-100 and 0.300 milliamp, dc. Each scale sells for 25 cents. R. E. Nebel Laboratory, 1104 Lincoln Place, Brooklyn, N. Y.

### Thermoplastic Material

MONSANTO CHEMICAL Co., St. Louis 4, Mo., has begun volume production for the military of Styramic HT, a new thermoplastic which holds its shape and strength at relatively high temperatures (distortion point is 236 deg.) and which has high insulating qualities. The material is easily molded.

# GOULD-MOODY

Improved

Professional Quality  
"Black Seal"

ALUMINUM  
INSTANTANEOUS  
RECORDING BLANKS



Technological advancements brought about by our wartime assignments provide critical engineers with "Black Seal" blanks of improved cutting and reproduction qualities plus more satisfactory play-back life.

### Rapid Deliveries to

Broadcasting Stations  
Recording Studios  
Motion Picture Sound Studios  
Schools and Colleges  
Governmental Agencies

Old Aluminum Blanks Recoated with  
"Black Seal" Formula on Short Notice



395 BROADWAY, NEW YORK 13, N. Y.  
Cable Address: Recordisc, New York, N. Y.  
Export Dept: Royal National Company, Inc.  
89 Broad Street, New York



**PARTS FABRICATED  
BY ROGERS**



KAYPAR fuel pump protector

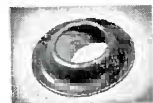

KAYGREY radio dust cover



KAYGREY magneto insulator



KAYGREY formed insert



DURO motor slot cell



DUROK capacitor can liner



BAYRU packing list protector



**SHE'LL BE USING DUROK\*  
- ANOTHER ROGERS-BORD**

**F**ABRICATED PARTS used to insulate capacitors, loudspeakers, antenna systems and other radio components are now "in work" in Rogers' fabricating division. The radio industry has seen that it can advantageously use Rogers-Bord—and can have Rogers form, draw, punch, bend and shape these tough, high-dielectric materials. Rogers designs and produces the necessary dies in its own tool and die shop. The Rogers "you name it, we'll make it" slogan applies to special fabricating as well as to special fibrous and plastic materials. And it applies now.

To learn more, check and mail:

- Send me the ROGERS EXHIBIT BOX, containing fabricated parts and samples of Rogers-Bord.
- Have a Rogers representative bring samples and fabricated parts.
- We are enclosing blueprint for suggestions and quotation.

NAME AND TITLE \_\_\_\_\_

COMPANY \_\_\_\_\_

ADDRESS \_\_\_\_\_

**ROGERS CORPORATION**  
Formerly  
The Rogers Paper Manufacturing Co.  
107 Mill St. Manchester, Conn.

**\*DUROK ROGERS-BORD**

Purified, non-cotton, cellulose fibers have now been wet-laminated into a new high-strength, high-dielectric material with the lowest extractibles ever. Data on this electrical insulating surprise are contained in "This Is Durok" Write for it.

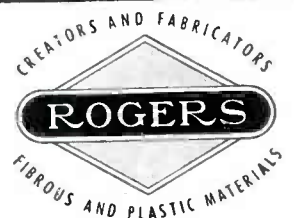



**ON PLANES, RADIOS, ELECTRONICS**

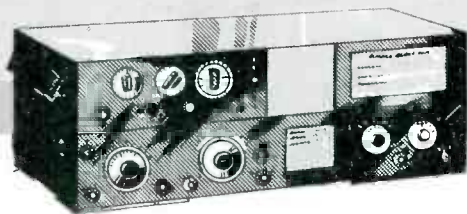

## *it's* HARRIS MOUNTS

It is impossible for delicate instruments such as those used on planes, radios, or in the electronic field to take jars, jolts, shocks, and vibration and still maintain their accuracy or function efficiently for any length of time.

Harris Mounts cradle, cushion and protect instruments by absorbing up to 90 per cent of this "rough going" which is the death knell to sensitive precision made-instruments.

Harris mounts are rugged, yet, extremely light in weight. They are made in accordance with Army-Navy standards to suit any combination of weight, frequency, deflection, or operating condition and come in plate and cup form. Send in for free Bulletin Series 1022, giving complete data on Harris Mounts.

Our engineers, long experienced in the field of engineered vibration control, will gladly work on your problem with your engineers. Just drop us a line.

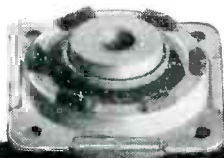

**HARRIS PRODUCTS COMPANY**  
CLEVELAND 4, OHIO, U. S. A.

### Miniature Electron Tubes

THESE MINIATURE tubes are designed for use in battery-operated radio receivers, hearing aids and other electronic circuit applications where light weight and compact-



ness are important considerations. These tube types include a complete line of T-5½ sizes manufactured by Sylvania Electric Products Inc., Emporium, Pa.

### Dielectric-Heating Unit

A NEW dielectric-heating unit (Megatherm Model MD-1A) developed by the Industrial Electronics Division of Federal Telephone & Radio Corp., Newark, N. J. has a nominal output of 1 kw, is portable and of compact design, for high-frequency heating of a wide range of dielectric materials. The unit occupies a floor space of 20 x 24



inches. It operates on 220 volts, single-phase, 60-cycle a-c outlet, and supplies 3500 BTU per hour at its operating frequency of 27 Mc. Other frequency ranges are available for special purposes, and where necessary the equipment can be provided for use with other power supply systems. Total power taken from the line is 2 kva, with an overall efficiency of 55 percent, and a power factor in excess of 90 percent.

# ME and the EARTH!

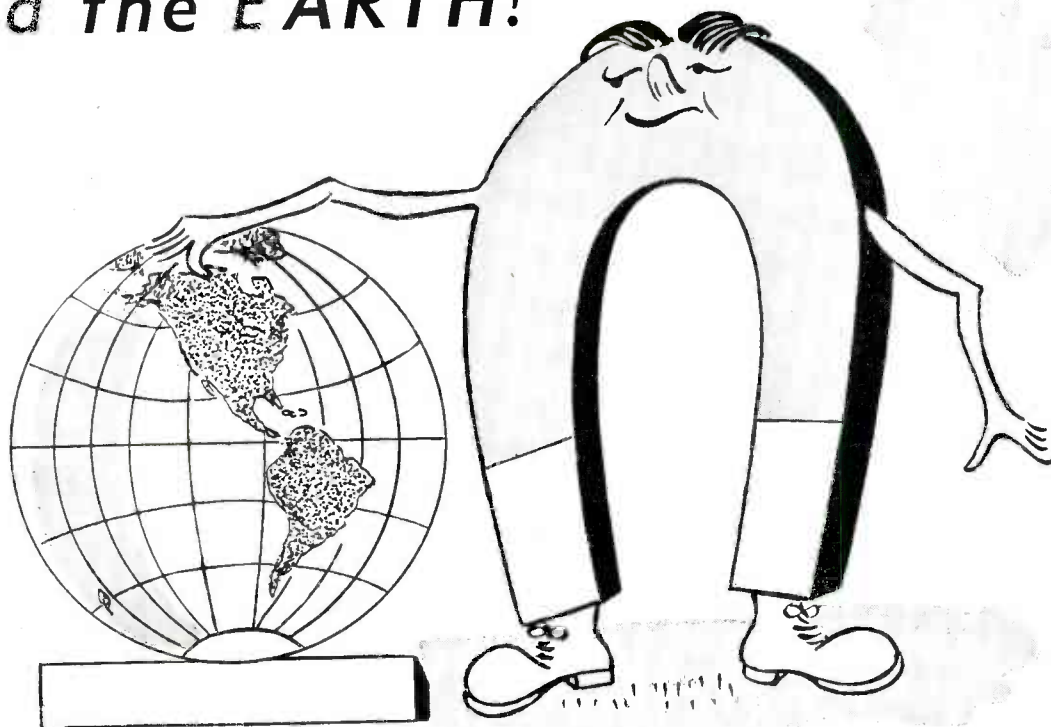

• What do we have in common? What does the earth have that I can claim, too? It's a permanency of energy content that staggers the imagination! Although learned scientists have been arguing for years on the subject, "How old is the earth and how long will it last?", they all talk in figures that sound like the public debt. Whatever it is, it's a long, long time that the earth has existed and will last and, mysteriously, I'll last just as long. Unless abused or used as I shouldn't be, my energy content will never lessen no matter how long I am asked to provide a magnetic flux.

Permanency of energy content is a good reason for *all* designers of apparatus requiring a magnetic flux to make use of the *permanent magnet* . . . More about permanent magnets is given in our booklet, PERMANENT MAGNET DESIGN. Why not send for a copy?



Typical of the many varieties of Permanent Magnets designed and made by CINAUDAGRAPH



## CINAUDAGRAPH CORPORATION

2 SELLECK STREET

STAMFORD, CONNECTICUT

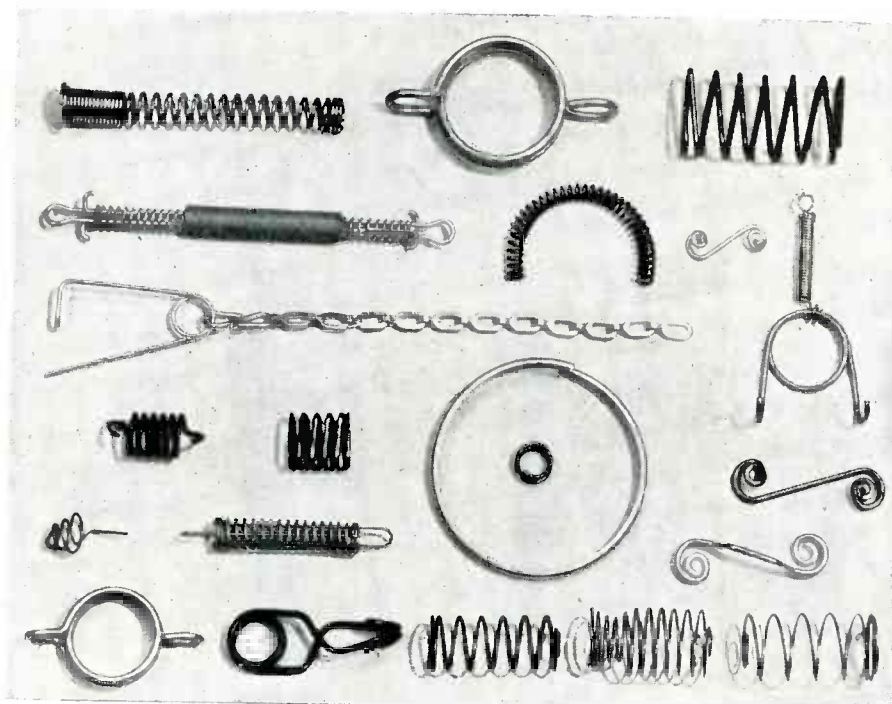

# DO YOU NEED SPRINGS OF UNIFORMITY & CLOSE TOLERANCES?



At the Reliable plant, our method of *scientific quality control* is based upon mathematically determined uniform frequencies of dimensional deviations. If this sounds complex, well, perhaps it is—but it's the system that safeguards Reliable Springs, so that fidelity to specifications, within given tolerances, actually approaches the absolute. Load factors, dimensions, squareness of ends, and other characteristics are rigidly controlled by statistical sampling. This painstaking inspection and testing process reduces to a safe formula the hazards to which all spring production is naturally subject. The final result is uniform, dependable spring performance.

Reliable makes all types of springs of round or square wire, or strip, as well as wire forms and light stampings. Reliable service to manufacturers is kept at a high level by an easily accessible and elastic organization of engineers and spring makers, always alert to your individual demands.

Advise us of your requirements. Catalog 44 sent on request.

## THE RELIABLE SPRING & WIRE FORMS CO.

3167 Fulton Rd., Cleveland 9, Ohio

Representatives In Principal Cities

**YOU CAN RELY ON**

# Reliable Springs

ROUND AND FLAT WIRE SPRINGS      CLIPS      HOOKS      BENDS  
LIGHT STAMPINGS

## Lifeboat Radio

NEW LIFEBOAT RADIO equipment, complete with helium-filled balloon which supports the antenna, is shown here being demonstrated by cadet midshipmen of the U. S. Merchant Marine Academy. By releasing the balloon to the 300-foot limit of the antenna wire, the crew of an abandoned ship is able to



summon aid from a point 1000 miles or more distant. The equipment includes a self-contained power generator (which replaces storage batteries), and two-way radiotelegraph and radiotelephone facilities. The equipment automatically transmits SOS and radio direction finder signals. Radiomarine Corp., 75 Varick St., New York, N. Y.

## Improved Converter Line

AMONG THE WAR application developments which have been adopted for all units are the new, special brass alloy slip rings with which Carter Motor Co., 1608 Milwaukee Ave., Chicago, Ill., has now equipped all units in its dc to ac converter line. Output of the units has been increased from 150-watt capacity to a 225-watt capacity.

## Battery Receptacle

A NEW THREE-CONTACT battery receptacle conforming to Army-Navy Specifications AN2552 has been released by Cannon Electric Development Co., 3209 Humboldt St., Los Angeles, Calif. The fitting mates with any standard AN2551 plug, and is adaptable to aircraft starting equipment and other uses. Four combinations are available.

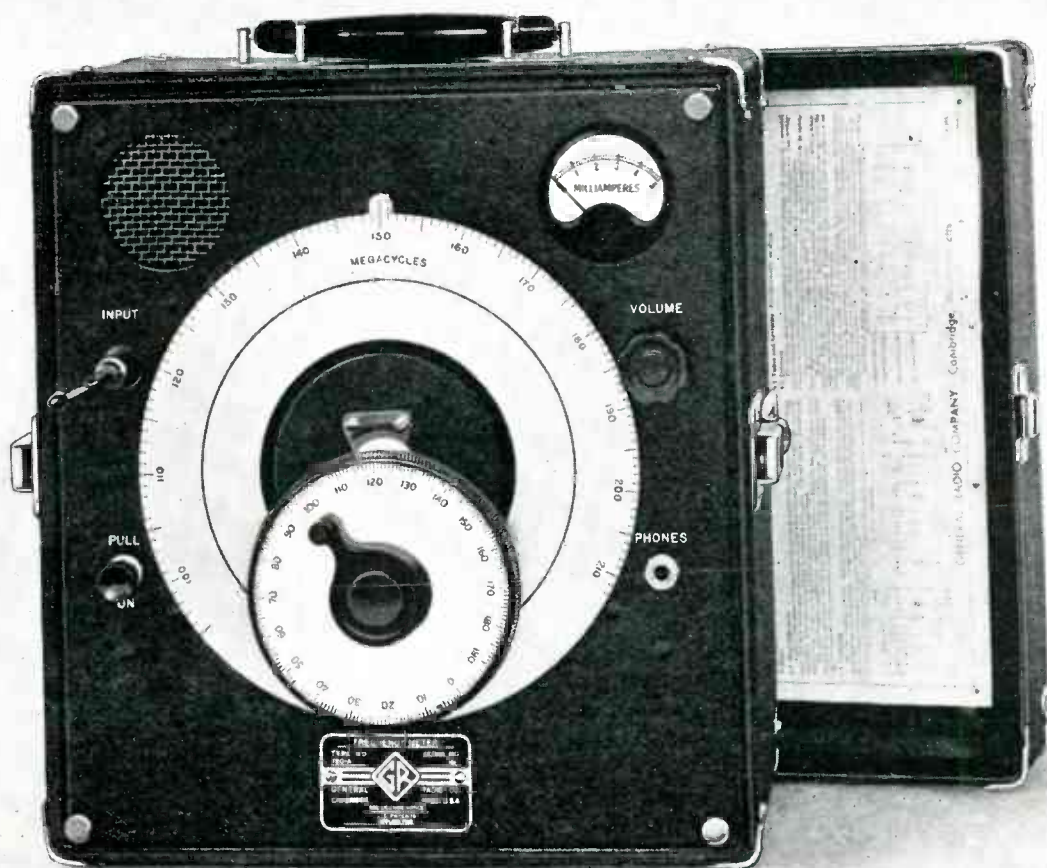

## For Measuring Frequencies Between 30 and 3,000 Mc

The new G-R Type 720-A Heterodyne Frequency Meter has all the operating conveniences of a broadcast-band type instrument, with a range of 30 to 3,000 Mc. Heterodyne methods offer several advantages over the conventional resonant type of meter. The fundamental frequency can be low enough to insure stability difficult, or impossible, to obtain with the resonant-circuit instrument. The heterodyne meter has much greater sensitivity and consequently requires much less r-f power to operate.

The fundamental frequency of this new instrument is continuously variable between 100 and 200 Mc. Frequencies above and below this range are measured by the use of harmonics. The tuning element is a butterfly circuit with rotor ball-bearings and no sliding contacts. The fundamental range is direct-reading in megacycles with a dial scale-length of 15 inches. One division of the auxiliary dial corresponds to a frequency change of 100 parts per million.

The built-in detector is a silicon crystal Type 1N21B. Usually no auxiliary pick-up is needed except when frequencies above 1,000 Mc are being measured it may be necessary to adjust the input antenna which is mounted on the front panel.

A three-stage amplifier is provided to produce indication on the panel meter when strong signals are received. Audible beats are simultaneously heard in the small speaker mounted behind the panel. A jack is provided for plugging in headphones for weak beat notes.

The complete instrument is self-contained. Its price, with batteries and spare crystal is \$250.00. At present this meter is available only for top-priority war orders. Reservation orders for future delivery, however, are being accepted.

For complete information see the G-R EXPERIMENTER for July, 1945.



# GENERAL RADIO COMPANY

Cambridge 39,  
Massachusetts

90 West St., New York 6    920 S. Michigan Ave., Chicago 5    1000 N. Seward St., Los Angeles 38

# You're Right!

## YOU CAN'T GO WRONG



with

# KESTER FLUX

- Because Kester makes the **RIGHT** Flux for every kind of solder-bond. Delicate, dip-soldered electrical connections, sweating operations, various types of seams, all demand a different and correct flux if they are to be permanent, and resist shock, vibration, bending, contraction, and expansion without failure!
- Because for 46 years Kester has pioneered in the field of solder and flux. Kester engineers and technicians have laboratory-tested a vast range of fluxes for every possible requirement. You can't go wrong with Kester flux.
- Because you can consult Kester engineers at any time for practical, experienced help. They'll gladly suggest the right flux to protect your product. A letter today will bring expert Kester assistance—with no obligation.

★ BUY WAR BONDS ★

### KESTER SOLDER COMPANY

4204 WRIGHTWOOD AVENUE, CHICAGO 39, ILL.  
Eastern Plant: Newark, N.J. Canadian Plant: Brantford, Ont.



# KESTER

## Solder Fluxes

STANDARD FOR INDUSTRY

### Remote Tuner

MODEL NO. EP6 is a remote tuning attachment for practical remote control for communication receivers. The attachment gives the operator precise and perfect control once the receiver has been tuned to the approximate frequency.

Illustrated is the front view of control panel carrying a line amplifier, loudspeaker and voltage-regulated power supply for remote tuner operated from 110 volts, 60 cycle. Units for other voltages and frequencies are available on special order. The frequency of the remote

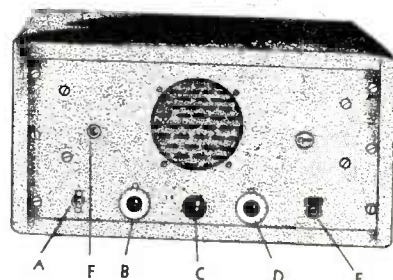

A—On-Off Switch  
B—Band Spread Control and voltage regulated Power Switch  
C—Tuning Control  
D—Volume Control  
E—Phono Jack  
F—Pilot Light

receiver is adjusted by a tuning control (c) which varies the capacitance of a small capacitor connected across the oscillator capacitor of the receiver. The band spread control and voltage-regulated power supply (b) adjusts the width of the band covered by a 300-deg rotation of the tuning control. (A band width of 40 kc is considered sufficient to take care of frequency drift in either the receiver or the transmitter or to tune out other interfering stations if possible.) A standard two-wire telephone loop, not exceeding 3000 ohms, may be used to connect the remote control panel with the receiver tuning unit. One pair carries the remote control voltage and the audio signal. The amplifier is supplied with a 500-ohm input. Special equipment is available for longer lines. The on-off switch is designated by (a), (d) is the volume control, (e) the phono jack, and (f) the pilot light.

A 4-page bulletin from Electronic Products Co., Ltd., 673 Homer St., Vancouver, B. C. describes this unit and contains data on Model EP-4 tuner.

# SCOVILL PLUGGED A NEW TECHNIQUE

## INTO RADIO TERMINAL JACKS

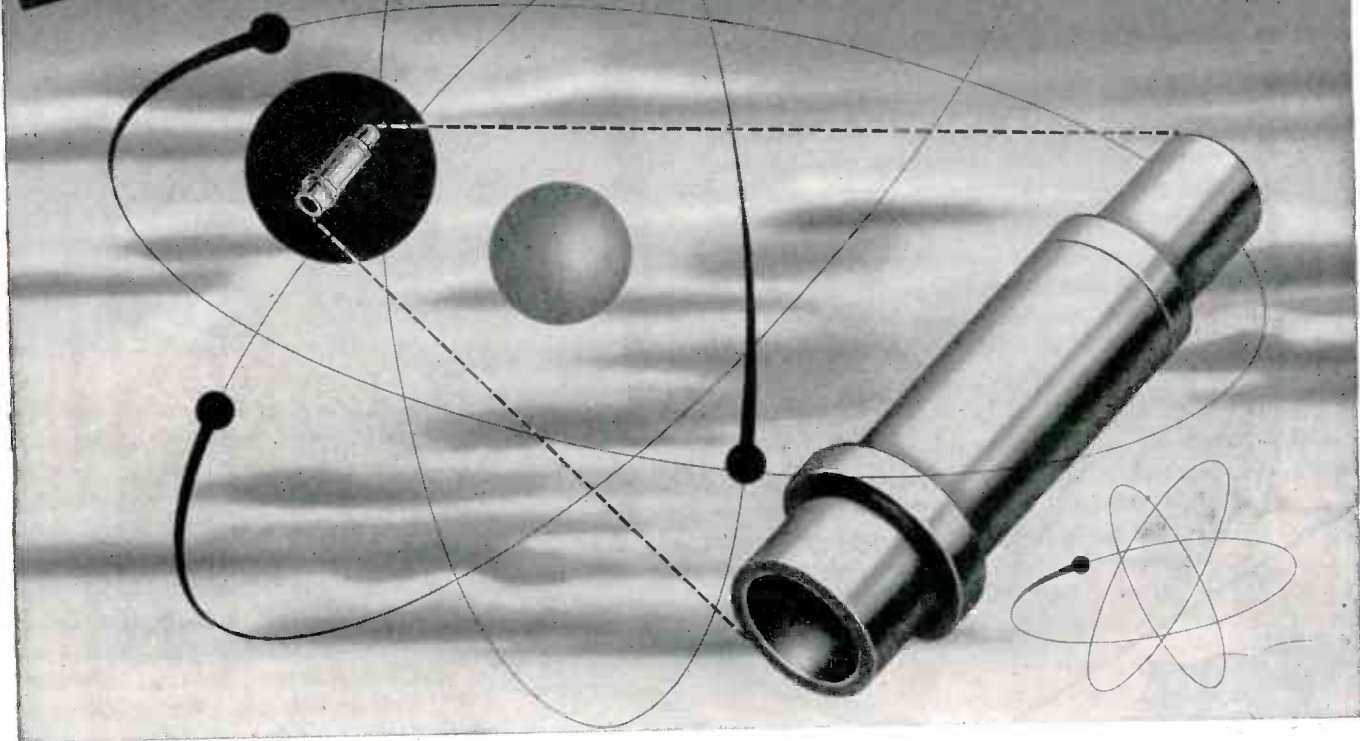

... and disconnected a tie-up



Terminal jacks for war-needed radios — screw-machined from rod stock — were lagging behind other parts. Expeditors called on Scovill to break the bottleneck.

Scovill did just that by shifting to high-speed stamping of sheet metal. This change in technique stepped up production greatly . . . cut down on scrap, always a problem in screw machine operations . . . turned out eminently satisfactory work . . . low-

ered costs by a substantial margin.

Scovill Electrōnents\* may also save time and money for you

Maybe your small electronic components or large assemblies can benefit from Scovill's versatility in forging, drawing, stamping, heading, or machining all kinds of metals and Scovill's impartiality in choosing the one method that will make your Electrōnents\* faster and better for less. For further details of Scovill's designing service and manufacturing

ability, send for literature. Use the coupon below and mail it today.

\*Electrōnents = Electronic Components



Please send me a free copy of "Masters of Metal" booklet describing your facilities. I am interested in the ELECTRONENT\* applications checked.

- |  |                                      |   |
|--|--------------------------------------|---|
| <input type="checkbox"/> Batteries       | <input type="checkbox"/> Dials       | <input type="checkbox"/> Panels             |
| <input type="checkbox"/> Record Changers | <input type="checkbox"/> Escutcheons | <input type="checkbox"/> Sockets            |
| <input type="checkbox"/> Clips           | <input type="checkbox"/> Jacks       | <input type="checkbox"/> Stampings. (misc.) |
| <input type="checkbox"/> Condensers      | <input type="checkbox"/> Lugs        | <input type="checkbox"/> Tubes              |

Other applications .....

### SCOVILL MANUFACTURING COMPANY

Electronic Division  
22 Mill Street, Waterbury 91, Connecticut

Name .....

Company .....

Address .....

# A COMPLETE RADIO STATION all in one package!

Typical of ERCO'S engineering ability to build completely coordinated Radio Stations is the unit illustrated. Built for Sperry Gyroscope Company, Inc., this equipment unifies a 200-watt radio telephone and telegraph transmitter, three 32-D fixed frequency receivers, one variable frequency receiver, speaker panels and operating position.

Variations of the illustrated console, in any combination of equipment, are available for your own needs. Panel assemblies can be interchanged to any arrangement. Each is replaceable to eliminate obsolescence.

ERCO'S specialized knowledge and technique is reflected in custom-built equipment for such varied users as Pan American Airways, American Airlines, General Motors, Eastman-Kodak, Grumman, Sperry, National Carbon, Westinghouse, and the Hudson's Bay Company.

Whatever your requirements . . . police, airline or industrial; mobile, ground to air, base to branch, office to field . . . ERCO provides complete service in the design, manufacture and installation of equipment that is engineered specifically to meet YOUR needs. We invite your inquiry.



## ERCO RADIO LABORATORIES

HEMPSTEAD, NEW YORK

Manufacturers of CUSTOM BUILT RADIO APPARATUS

### Tube Sockets

A NEW SERIES of transmitting and receiving tube sockets molded of Mykroy (a mica ceramic h-f insulation which will not carbonize or otherwise deteriorate in high heat or electric arcs and flashovers) include standard 4, 5, 6 and 7 prong types, octal and loctal sockets, 5 and 7 prong acorn sockets; 4-prong high-voltage rectifier sockets, and improved heavy-duty "50 watters." Sockets are produced by compres-

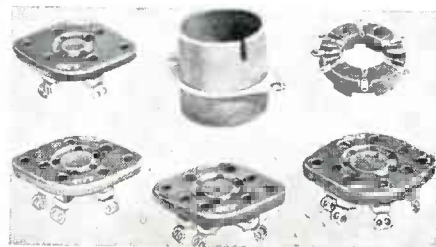

sion molding and are of one-piece construction featuring spring phosphor bronze contacts anchored to the sockets so that they are rigid and non-turning. An 8-page bulletin (No. 104) entitled "Mykroy Parts and Accessories for Electronic, Radio and Radar Tubes" contains complete information and illustrations of sockets, tube parts and accessories. Write Electronic Mechanics, Inc., 70-88 Clifton Blvd., Clifton, N. J.

### Resistors

AN IMPROVED LINE of non-inductive resistors includes Types RL and SL manufactured by Instrument Resistors Co., 25 Amity St., Little Falls, N. J. Type RL is rated  $\frac{1}{2}$  watt with a maximum resistance of 500,000 ohms. It measures  $\frac{1}{2} \times \frac{1}{2}$  in. Type



SL has a maximum resistance of 1 megohm and measures  $\frac{1}{2} \times \frac{1}{8}$  in. Both resistors are furnished with a standard tolerance of  $\frac{1}{2}$  percent.



Fiberglas\* Tying Cord puts the finishing touch on a quality Job



Fiberglas Tying Cords, ranging in size from 1/64" to 1/8", are an important part of the complete line of Fiberglas Electrical Insulation Materials. They are being widely used for all types of tying purposes on electrical equipment, or where high strength tension member is required.

Universally adaptable Fiberglas Cords provide all of the advantages inherent in Fiberglas, such as: heat, moisture, acid resistance, and exceptionally high tensile strength-to-size ratio. For example, the minimum breaking strength of 1/32" Fiberglas Cord, number EC5-1, is 66 lbs., that of 1/8" cord, number EC5-8-T, is 274 lbs.

#### Does many Jobs . . . Better

Fiberglas Tying Cords are widely used for banding field coils; for wrapping string bands on small armatures; for protecting front of the commutator V-ring from flashovers on motors; as banding, on the V-ring extensions on some d-c equipment; as filling, in winding certain coils; for reset strings; and for tying slot insulation in place. It is also used to lash ends of coils in large motors and generators, and to hold spacer blocks in place.

In general, Fiberglas Cords are from three to five times as strong as ordinary electrical twines. Therefore, Fiberglas Cords, smaller in size than cords of other materials, can be used for many applications.

#### Treated or Untreated

Treated cord is used primarily for its increased knot strength and abrasion resistance. For general applications in the construction or repair of electrical equipment, the treated cord is preferred. Where space is to be filled, regardless of strength requirements, the untreated cord is frequently used.

#### Complete Information

The new Fiberglas catalog EL44-7 gives performance and application data of interest to anyone concerned with electrical insulation—also facts about Fiberglas Tapes, Fiberglas-Insulated Wire and Cable, Fiberglas-Mica combinations and other Fiberglas-base Materials. Write for a copy today, and ask for the name of the supplier located nearest to you.

Owens-Corning Fiberglas Corporation, 1860 Nicholas Building, Toledo 1, Ohio.

In Canada, Fiberglas Canada Ltd., Oshawa, Ontario.

There is a  
**FIBERGLAS**  
Insulation Material  
for every need



Fiberglas Tying Cords are available in sizes from 1/64" to 1/8", in 1/64" increments.

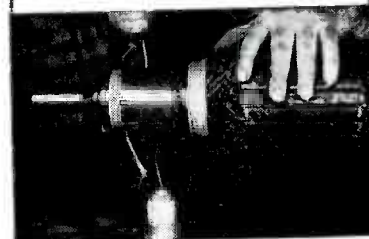

Fiberglas Tying Cords are widely used for banding commutator leads, and over V-ring extensions.



Used most frequently because of its high strength-to-size ratio—as shown in this stator tying application.

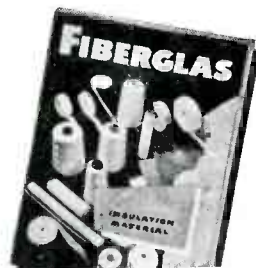

Write for catalog EL 44-7, today.

Each distributor of Fiberglas-base Insulation Materials has his own source of supply, since Owens-Corning Fiberglas Corp. does not process these materials.

# FIBERGLAS

\*T, M, Reg. U. S. Pat. Off.

## ELECTRICAL INSULATION MATERIALS





## Here's the Heart of Postwar Radio

Crystal-clear reception is a requisite feature to the American public in its postwar radio sets. And crystal control, as you know, is a positive and dependable answer to avoidance of strays, static and other undesirable signal.

Pan-El is ready now to work with any radio, fm or other electronic device manufacturer who knows the importance of engineering crystal control into his postwar circuits. Our staff of Electronic Engineers, veterans now, is always at your service, and eager to help you take full advantage of the quality our crystals can bring to your apparatus. We are in quantity production even of the most difficult types.

**PAN-EL**ectronics LABoratories, Inc.

500 Spring St., N. W., Atlanta, Georgia



QUANTITY PRODUCERS OF STANDARD AND SPECIAL

# Control Crystals

### Ionization Gage

PRECISION-TELEVAC ultra vacuum gage, designated as type E-31, is the result of years of research. Electrical leakage is completely eliminated and, when used with a moderately high-speed pumping system, the gage outgasses itself. Filament is automatically protected before and during operation, since current will not enter filament be-



fore pressure of 1 micron has been established and turns off automatically if pressure rises above 1 micron. Gages are interchangeable without recalibration and are guaranteed for 1000 hours. Bulletin No. 450-R illustrates and describes a complete line of Televac precision instruments. Precision Scientific Co., 1750 N. Springfield Ave., Chicago 47, Ill.

### Recording Galvanometer

THIS GALVANOMETER utilizes a 3-in. long tapered recording pen which is actuated by a permanent magnet penmotor. The pen is Pyrex tipped and records directly in ink (on a moving paper chart) the pressures, vibrations, strains, currents and voltages of frequencies from d.c. to 120 cps. It has no overshoot up to 70 cps at a maximum swing amplitude of 20 mm each side of center line. Frequency response is flat to 70 cps, accurate to 120 cps. The pen can be centered, or raised from



August 1945 — ELECTRONICS

Obtaining the characteristics of aluminum foil samples in order to insure uniform Aerovox quality of each unit throughout production.



An Aerovox capacitance bridge for measuring capacitance, equivalent series resistance, leakage and other electrical characteristics of electrolytics.

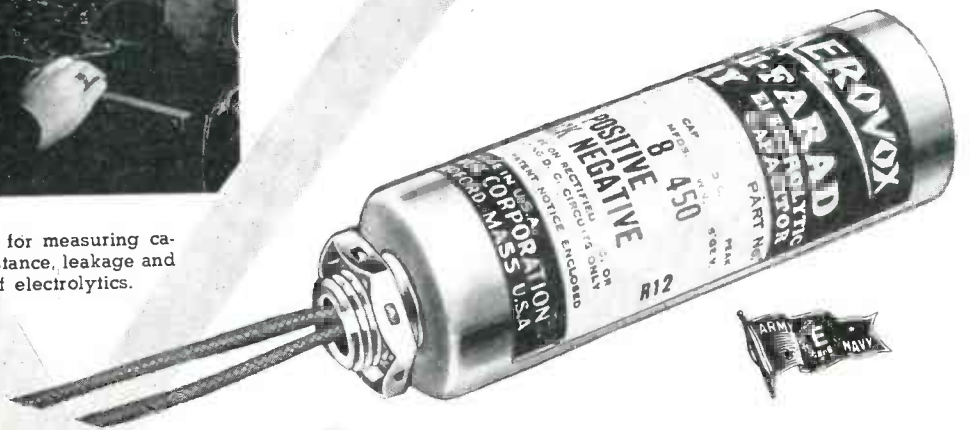
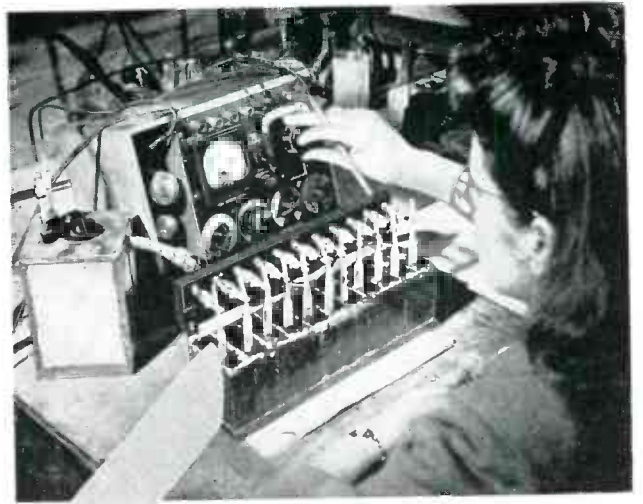

✓✓✓✓✓ from **START to FINISH** insures **AEROVOX**  
*Craftsmanship*  
**CAPACITOR**

● Inspection—especially when backed by critical instrumentation—insures Aerovox Capacitor Craftsmanship.

With Aerovox electrolytics, for example, production is checked from *start to finish*—from the pre-checking of each constituent material used in the production of electrolytics, to the checking of completed units for their electrical and physical characteristics.

Because of the extra-critical inspection standards, most of the test equipment is designed by Aerovox

engineers and built in their own engineering laboratories. Hundreds of such exclusive Aerovox instruments are in daily use on the production line— instruments seldom seen outside a laboratory— mounting guard at every step from raw material to finished product.

It is such outstanding inspection routine, along with skilled and conscientious workmanship, plus engineering judgment, that accounts for that widely recognized Aerovox Capacitor Craftsmanship.

● Literature on request.



*Capacitors*

**INDIVIDUALLY TESTED**

AEROVOX CORPORATION, NEW BEDFORD, MASS., U. S. A.

SALES OFFICES IN ALL PRINCIPAL CITIES

Export: 13 E. 40 St., NEW YORK 16, N. Y. • Cable: 'ARLAB' • In Canada: AEROVOX CANADA LTD., HAMILTON, ONT.

# SUPER ELECTRIC



Producing Quality Components  
on a Mass Basis

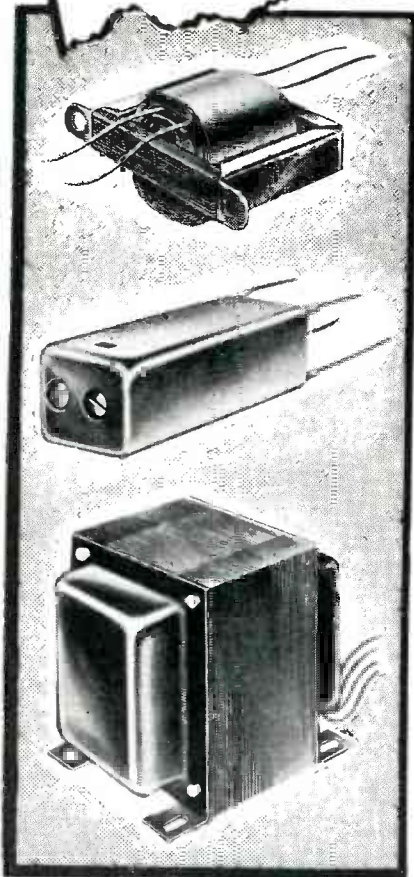

Seasoned people — not "Pearl Harbor babies" — are in our production army. For war or peace, Super Electric transformers and radio coils are controlled by the same high quality standards.

## Super Electric Products Corp.

1057 Summit Av., Jersey City, N. J.

Transformers for: Power · Audio Frequency · Luminous Tubes

the chart. Impedance of penmotor is 1500 ohms. Maximum sensitivity is 1.1 mm per volt, 1.6 mm per ma, 21 volts full scale. Overall dimensions of the unit are 5 x 4 x 1 1/2 in. The Brush Development Co., 3405 Perkins Ave., Cleveland 14, Ohio.

### Volume Level Indicator

ALTHOUGH DESIGNED primarily for use across balanced lines, this instrument (designated as Type 920 for low-level indication) will also permit either side of bridged lines to be grounded. The unit utilizes a copper-oxide type indicating meter adjusted for deliberate pointer action, a meter zero-adjusting control and a heavy-duty meter range control variable in steps of 2 vu, 100 to 130 volt, 60-cycle a-c



power supply with voltage regulator to adjust for normal supply variations. Specifications are: range -20 to +20 vu meter reading; extreme range -40 to +23 vu, including full meter scale; standard reference level 1 mw into 600 ohms; variation with frequency is rated less than 0.2 db between 30 and 15,000 cycles. The unit is mounted on a panel for use in standard relay rack. The Daven Co., 191 Central Ave., Newark, N. J.

### Component Aid

FOR MANUFACTURERS of capacitors, can liners are available which are fabricated with scores, punches and slits to the exact specifications of the manufacturer. Liners are avail-

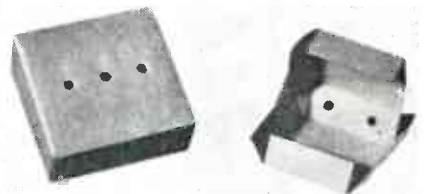

able in various insulating papers including drawtex, hitex, beaming kraft, kraftage, fish papers, etc. Howard J. Moore Co., 108 Park Row, New York 7, N. Y.



**DEPENDABLE  
TROUBLE-FREE  
OPERATION**

**The new post-victory  
line of**

**SEEBURG  
RECORD CHANGERS**

**will have**

**FEWER MOVING PARTS**

**BUY WAR BONDS** →

Awarded to the J. P. Seeburg Corporation for outstanding production of war materials in each of its four plants

**Seeburg**

**J. P. SEEBURG CORPORATION · CHICAGO**

FINE MUSICAL INSTRUMENTS SINCE 1902

**FOR POST-WAR REQUIREMENTS**  
**40 YEARS OF EXPERIENCE AT YOUR SERVICE**

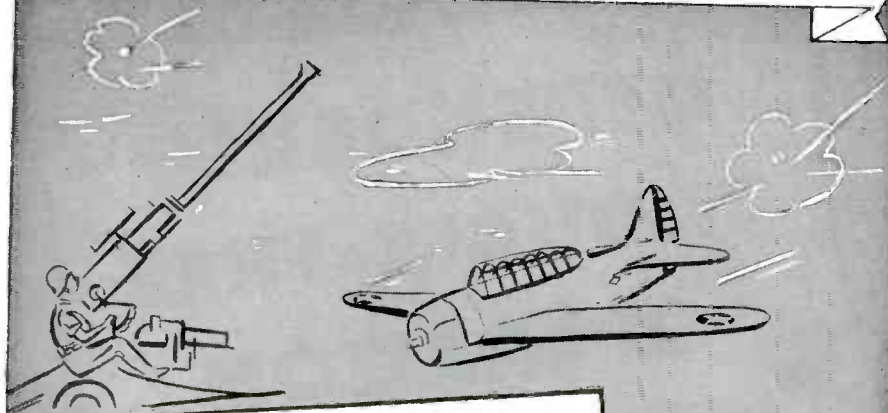

*Willor Makes It!*

... and makes it with a high degree of precision and cooperation born of our concentrated experience in meeting wartime's rigid requirements and schedules. From raw stock to completed items... Willor service embraces every facility for planned production.

*We Invite Inquiries and Blueprints*

- METAL STAMPINGS
- MACHINE WORK
- LAMINATIONS
- TOOLS AND DIES
- PANEL BOARDS
- PLASTIC PARTS
- MECHANICAL AND ELECTRICAL INSTRUMENTS

**WILLOR**  
**MANUFACTURING CORP.**

794 E. 140th St., New York (54) N. Y.

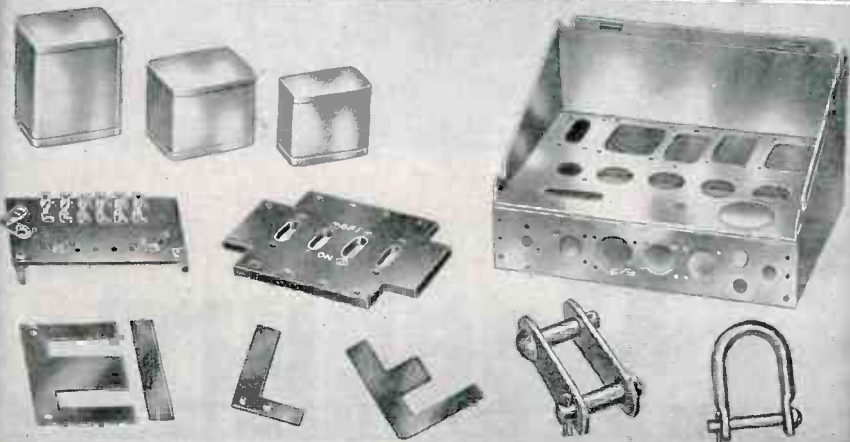
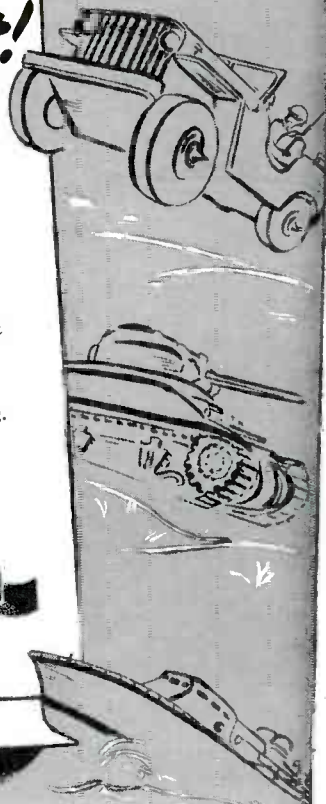

**BACK THE ATTACK -- BUY MORE WAR BONDS**

**Rectifiers for Magnetic Chucks**

IN INDUSTRIAL electronic control applications these magnetic chuck rectifiers convert 110-volt ac to 110-volt dc. Units embody full-wave rectification (by electron tubes mounted on shock-proof bases, precision-built transformers, capacitors and easily-replaced protection fuses.) Model No. 2 delivers 2 amp (approximately 250 watts) at 110-volt dc, and Model No. 6 delivers 6 amp. Two No. 6 units can be used to obtain 12-amp output. Davis & Murphy, 5252 Broadway, Chicago 40, Ill.

**Directional Loudspeaker**

MODEL B-6 IS a high-powered directional loudspeaker which has a range of approximately 1 mile over open country and 2 miles over water. It is primarily for use in speech reproduction. It has a fre-



quency range of 300 to 5000 cps and handles 150 watts of audio power. Six driver units power the speaker. The unit is waterproof and is available from University Laboratories, 225 Varick St., New York 14, N. Y.

**Thermo-Plastic Tape**

FIBRON TAPE (No. 3) is a transparent, flexible thermo-plastic tape which can be used as electrical insulation or to protect wiring, cables and other equipment against abrasion. The tape is heat sealing, flame resistant, flexible at low temperatures, and resists attack by acids, alkalis, moisture, oil, grease and corrosive fumes. With proper adhesives, it can be bonded to fabrics, metal, ceramics, wood, and other materials. Irvington Varnish and Insulator Co., 6 Argyle Terrace, Irvington, N. J.

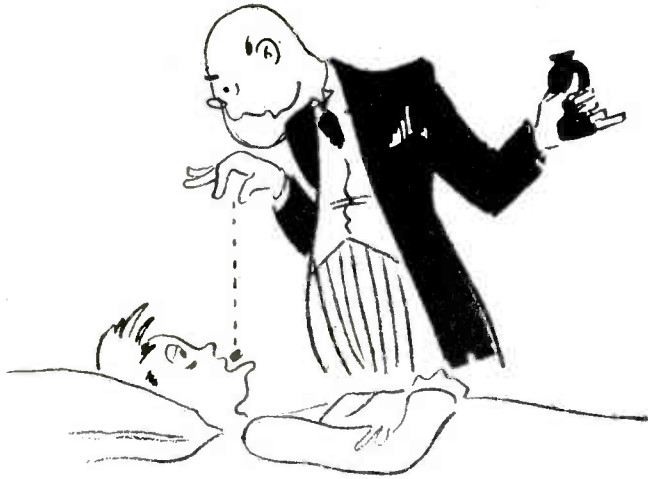

**GOOD MEDICINE**  
for your control or protection problems

## KLIXON Snap-Acting CONTROLS

A quick, clean "break" or a solid "make" . . . that's what you get when you use Klixon Snap-Acting Controls in such applications as motor and transformer overheat protection, electrical circuit overload protection, thermal time delays or temperature control for radio equipment. These small, compact, lightweight controls operate surely and accurately no matter how often they operate. Because they have no toggles, or other complicated parts, they give foolproof control or protection even under vibration, shock, motion or altitude. They are available in a wide range of standard types with ratings to meet practically all requirements . . . and in sizes that can easily be incorporated into most mechanical design plans.

Our engineers will gladly help you with your control or protection problems. Write for their services today.

**SPENCER THERMOSTAT COMPANY • ATTLEBORO, MASSACHUSETTS**

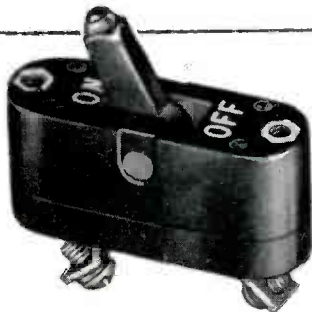

Type C-6363  
Switch Circuit Breaker

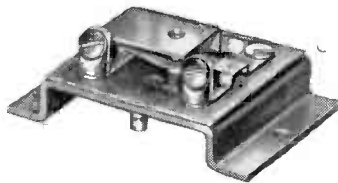

Type C-4351 Thermostat. Used for Tube Warming, Tube Cooling, High Limit Controls, etc.



Type RT Thermostat. Adjustable Temperature Control.



Type C-7220 Precision Snap Switch 12 amps, 30 Volts D. C., 125 Volts A. C.



Type C-2851 Thermostat. For such use as Roughing Controls on Outer Crystal Ovens.



Type ER Series. Ambient Compensated Time Delay Relays.

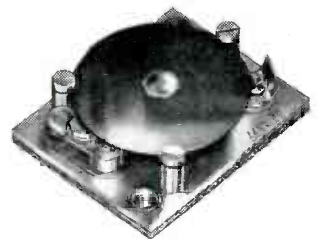

Type B-3120 Thermostat and Heater, Crystal Dew Point Control.

*"More than Satisfactory"*

is the verdict of radio engineers who have specified Blaw-Knox Vertical Radiators and Antennas for an imposing number of important stations employing AM, FM and VHF.

**A**LSO, Blaw-Knox has supplied Towers for Directional Radio Beacons to guide all air transport service in the United States, as well as military electronic developments still on the restricted lists . . . For strict adherence to your specifications plus wide experience in structural design and fabrication, you can count on Blaw-Knox to complete a contract which will prove "more than satisfactory."

## BLAW-KNOX DIVISION

of Blaw-Knox Company  
2077 FARMERS BANK BLDG.  
PITTSBURGH PENNA.

**BLAW-KNOX VERTICAL RADIATORS**

## Dual Channel Oscilloscope

ONE OF THE features of this oscilloscope is that it is possible to observe two separate phenomena on the same cathode-ray tube screen simultaneously without the use of an electronic switch. Two separate channels feed into a single 5-in. cathode-ray tube. Both beams on 100 per cent of the time result in a maximum brightness of trace.



Intermodulation is minimized by the use of two channels which are isolated from each other. The instrument (Model E-2G) can be supplied with a cathode-ray tube having screens of medium persistence green (P1), long persistence green (P2), white (P4), and short persistence blue (P5 or P11). Electronic Tube Corp., 1200 E. Mermaid Ave., Philadelphia 18, Pa.

## New Tubes

THREE MANUFACTURERS announce tubes as follows:

Chatham Electronics, 475 Washington St., Newark 2, N. J. Type 3B28 inert gas-filled rectifier tube is rugged and is designed to operate over wide variations of ambient temperature without the use of temperature control devices. Ratings

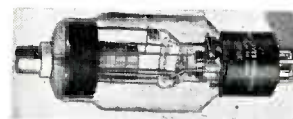

are: Peak inverse voltage 10,000 volts, peak plate current 1.0 amp; average plate current 0.250 amp; tube voltage drop 10 volts. Filament current is 5.0 amp at 2.5 volts. At 500 cycles or less, the peak inverse voltage rating is 6,500 volts at 2 amp peak plate current, 0.5 amp average plate current. Base is



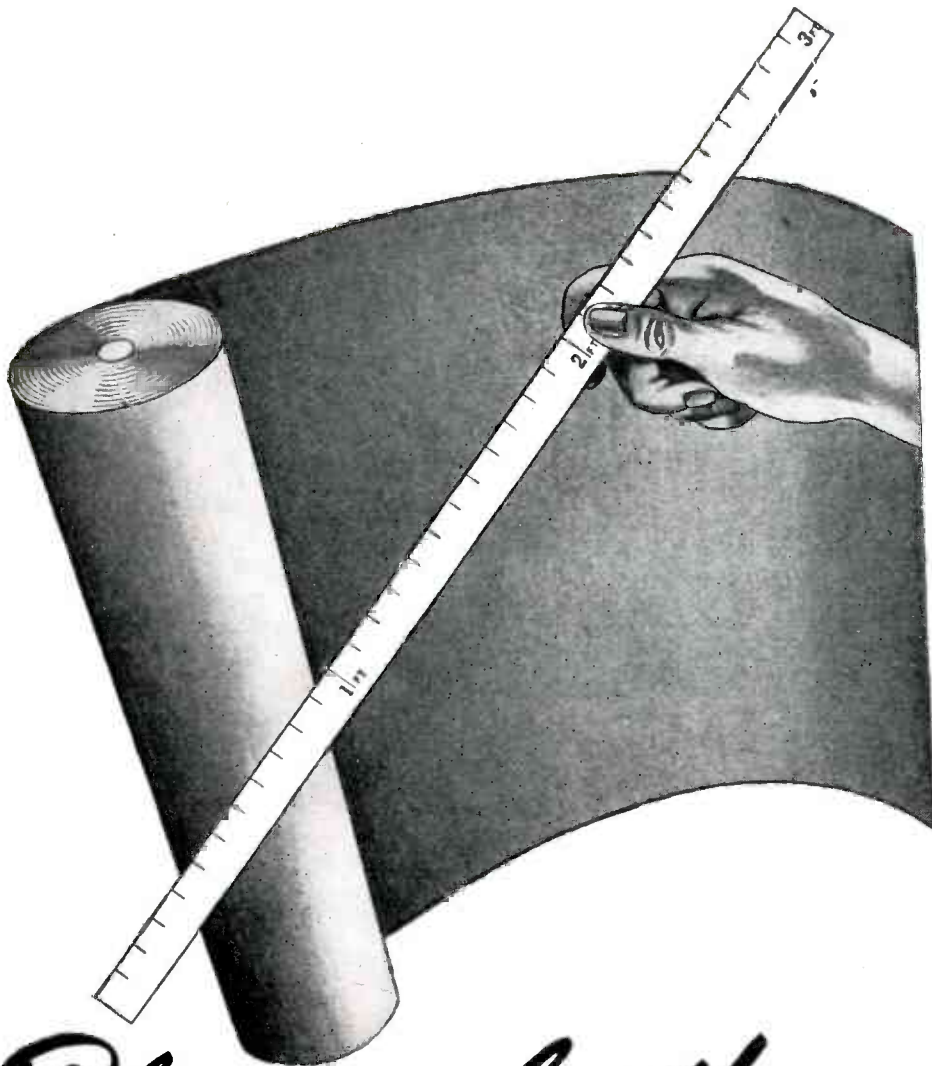

# Plastics by the yard

Many types of reinforced plastics are called plastics because the plastic coating or covering bulks larger than the base. Holliston Processed Cloths differ from the usual conception of plastics because the base usually bulks larger than the resin and because the plastic and structural materials are not laminated or combined, but are made integral through impregnating or inter-mesh filling. However, in modernity, utility and effect, Holliston Processed Cloths are special purpose plastics and should be valued as such, even though bought by the yard instead of by the piece or pound.

Think of Holliston Processed Cloths as "flexible plastics" They range in weight from tissue-thin cambrics to coarse, rugged burlap; and possess special functional and or decorative characteristics. They may be folded, creased, sewn or cemented. Consider them as a possible solution of materials problems in postwar planning.

Consult our Research Department.

## The HOLLISTON MILLS, Inc.

Processors of Cloth for Special Purposes

NORWOOD, MASSACHUSETTS

Sales Agents in Principal Cities

### Cloth Bound

A cloth bound book is bound to be kept — bind your

CATALOG — SALES MANUAL — INSTRUCTION BOOK, ETC.

in HOLLISTON Book Cloth — durable, impressive, hard-to-soil, easy-to-clean.

Write for samples.

Consult your printer.

### SPECIAL FINISH

HOLLISTON special finish cloths meet special needs —

TRACING CLOTH — PHOTO CLOTH — RUBBER (PROCESSING) CLOTH — BOOK CLOTH — SHADE CLOTH — SIGN CLOTH — TAG CLOTH.

Cloth combined with special compounds, filled, impregnated, coated — to form a material with characteristics of a plastic and the flexible strength of a woven fabric.



**KEEPING PACE WITH**

*Jet Propulsion...*

★ Jet propulsion promises great things for aviation—today and tomorrow. Years of research and experimentation are behind jet planes, which embody the latest advancements in aircraft engines.



Naturally, only materials with the demonstrated ability to meet the rigorous demands of modern aircraft applications are used. We take pride in the fact that C.M.H. Stainless Steel Bellows, both small and extra large, are being used in jet propulsion engines. For C.M.H. is making sure that its products are keeping pace with the changing needs of aviation . . . and other industries as well. Write the Chicago Metal Hose Corporation today for Form SS B 2 on which to submit your bellows requirements. It will save you time . . . assure more accurate transmittal of essential data.

**OUTSTANDING FEATURES OF C.M.H. STAINLESS STEEL BELLOWS**

- Highly resistant to heat.
- Corrosion resistance of 18-8 Austenitic Stainless Steel.
- Pressure-tight for searching liquids and gases.
- Have the strength for high-pressure service.
- Uni-metal assemblies . . . do away with the hazards of solder.

**Flexible Metal Hose for Every Industrial Use**



**CHICAGO METAL HOSE CORPORATION**  
MAYWOOD, ILLINOIS

Plants: Maywood and Elgin, Ill.

medium 4-pin bayonet type. Top cap.

Amperex Electronic Corp., 79 Washington St., Erocklyn 1, N. Y. Type 233 transmitting tube designed for use as class C oscillator or amplifier or for generating r-f power at frequencies up to 30 Mc. Filament voltage is rated 24 volts;

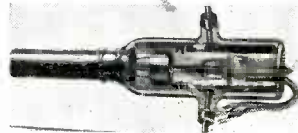

current 70 amp; thermionic emission 16 amp; amplification factor 52; direct interelectrode capacitance: grid to plate 24  $\mu\mu\text{f}$ , grid to filament 22  $\mu\mu\text{f}$ , plate to filament 1.5  $\mu\mu\text{f}$ .

Taylor Tubes, Inc., 2312 Wabansia Ave., Chicago, Ill. Type 822-S high-power triode with a frequency application limitation of 30 Mc. The tube is designed for peak performance in all r-f services, diathermy and class B audio. It may also be used in induction-heating applications. Electrical characteristics are:



Filament 10 volts at 4 amp; amplification factor 30; plate dissipation 200 watts. Interelectrode capacities: grid to plate 13.5  $\mu\mu\text{f}$ , grid to filament 8.4  $\mu\mu\text{f}$ ; plate to filament 2.1  $\mu\mu\text{f}$ . Maximum overall length is 9 in. Plate dissipation 150 watts, power output 600 watts, driving power 17 watts.

**Multi-band Cathode-Ray Tube**

TYPE 5RP (designation assigned by RMA) multi-band cathode-ray tube is of the hot-cathode, permanently-sealed, high-vacuum type and is for use in ultra-rapid writing rates. Subdivision of the intensifier element provides a controlled gradient allowing a total accelerating potential of 17,500 volts to be employed with only slightly reduced deflection sensitivity. The tube permits recording at writing rates in excess of 2500 km/sec (using a 35-mm camera with an f 1.9 lens) corresponding to sine-wave transients at 40 Mc. Allen B. DuMont Labs., Inc., 2 Main Ave., Passaic, N. J.

# The Complete Line OF RECTIFIERS AND PHOTOTUBES CETRON



Particularly sensitive to blue and violet light. RMA spectral sensitivity designation S-4. 5-Pin base interchangeable with other similar tubes.

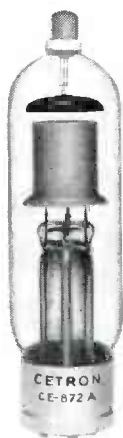

Rectifier designed to meet rigid Army and Navy specifications. Incorporates numerous improvements insuring efficiency, ruggedness and long-life.



Grid control Rectifier (Thyratron) especially suited for industrial use, such as handling primary currents of small resistance welders—motor control, etc.

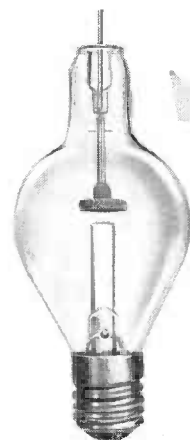

CE-235 is a half wave Argon-filled Rectifier with screw base, sturdily constructed for long, dependable service.

Cetron Rectifiers are available in gas and mercury filled, both full and half wave types in a wide range of ratings.

Cetron Phototubes are produced by us to take care of almost every situation . . . over 50 types, both blue and red sensitivity.

Continental's long experience and careful production methods insure you the utmost in satisfaction from all the many types of tubes we make. Write for complete catalog.



**CONTINENTAL  
ELECTRIC COMPANY GENEVA, ILL.**

★ CHICAGO OFFICE, 188 W. Randolph Street  
NEW YORK OFFICE, 265 West 14th Street



*Origin of a hurricane-*

## CANNON PLUGS IN ALL CIRCUITS OF THE CALTECH WIND TUNNEL

One of the fans in the cooperative wind tunnel—owned by Consolidated Vultee, Douglas, Lockheed and North American—operated by the California Institute of Technology.

Two fans, each 21 feet 9½ inches in diameter, with a main drive of 12,000 hp. maximum, develop an air speed of over 700 m. p. h. in this new aircraft testing machine. Models are tested under air pressures ranging from one-quarter atmosphere to four atmospheres. Aerodynamic forces and moments are measured accurately, readings automatically recorded.

More than a thousand Cannon Connectors are employed in the electric circuits of the installation. Their use makes possible the quick and easy interchange of equipment, eliminates the duplication of costly instruments, increases the accuracy of the records taken.

Cannon Connectors, available in many thousands of standard capacities, sizes and types, may serve well in the circuits of the instruments you use or the products you manufacture. Write for a Condensed Catalog. Cannon Electric Development Co., Dept. A-120, 3209 Humboldt St., Los Angeles 31, California.

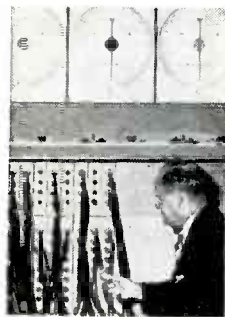

*Above:* Measuring dials recording forces and moments through control panel of Cannon Connectors. *Left:* Special Cannon Connector for portable control and recording unit. *Below:* Cannon Plugs used on measuring and recording machines designed and installed by International Business Machines Corporation.



## Coaxial Cable Grooving Tool

ILLUSTRATED IS a coaxial cable grooving tool which is designed to expedite the work of radio engineers and maintenance men. It makes better soldered splices in ¼-in. coaxial cable and can also be used to make strong soldered joints on ⅜-in. diameter tubes used in plumbing, heating and refrigera-

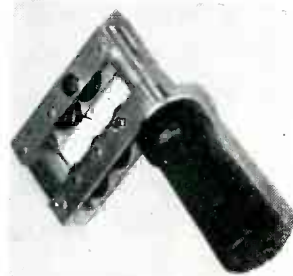

tion. Easy and fast to operate, the tool makes spun-in grooves in the splicing sleeve that grip the outer conductor firmly. This operation makes a secure joint and prevents the solder from entering the cable. Easily replaceable cutting wheels are used to cut the outer conductor. Andrew Co., 363 East 75th St., Chicago 19, Ill.

## Selenium Rectifiers

TYPE K SELENIUM rectifiers which do not show any effects of salt spray after 100 hours of operation at 50 deg C are announced by Selenium Corp. of America, 1719 W. Pico Blvd., Los Angeles 15, Calif. The manufacturer has used a new method of assembly and coating technique. The new coating protects the selenium barrier layer from within and preserves its rectifying properties indefinitely. It also protects the barrier layer from exterior attacks by salt spray, fungi, mercury vapor and other



## CANNON ELECTRIC

Cannon Electric Development Company, Los Angeles 31, California

Canadian Factory and Engineering Office:  
Cannon Electric Company, Limited, Toronto

Representatives in Principal Cities—Consult Your Local Telephone Book



*Someday, when you need  
coordinated facilities for  
stamping, welding,  
fabricating, machining—  
think of*



**POLLAK MANUFACTURING COMPANY**

**Arlington, New Jersey**

**DEVELOPING • DESIGNING • MACHINE WORK • SPINNING  
GAS AND RESISTANCE WELDING • STAMPING • ELECTRICAL WORK**

# WAR RESTRICTED DEVELOPMENTS

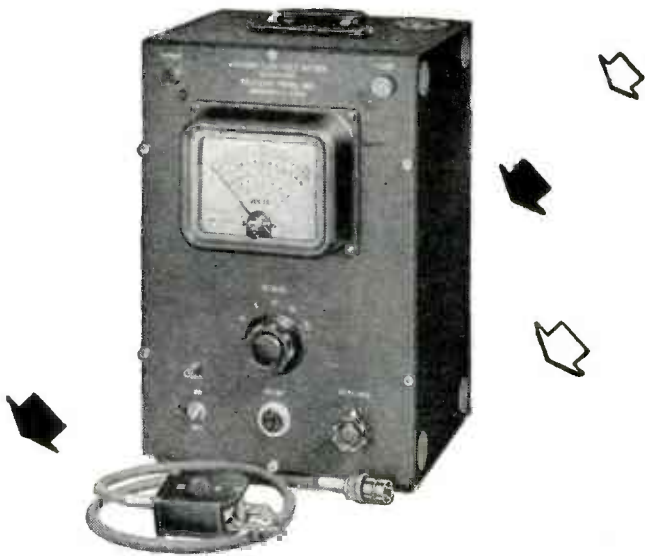

## Now Available

in TELEVISO Series 200A  
Vacuum Tube Voltmeter

TELEVISO, pioneering in the production of measuring apparatus for the SONIC to UHF SPECTRUM, has specialized in building dependable Vacuum Tube Voltmeters.

A necessity wherever dependable voltage measurements within the range of 7 cps to 500 megacycles are required—the Televiso Series 200A VT Voltmeter is highly accurate and stable.

### FEATURES:

**SUPERSENSITIVE RANGE**—the lowest readable voltage is .05 volts on a maximum scale range of .5 volt.

**FIVE VOLTAGE RANGES**—.5, 2, 15, 50, 150—spread full scale on a 4½" meter dial for easy reading. Accuracy of readings are 2% full scale; middle scale accuracy is 5% or better.

**PROBE CONSTRUCTION**—detachable probe to eliminate cable wear; easily dismantled for tube replacement or for soldering to tube terminals for measurements in the 250-500 MC region; flat ½" wide brass terminals connect to input to make easy soldering to test or work piece; for low frequency work up to 100 MC, removable banana plugs are spaced ¾" center to center for use with standard jacks.

**MECHANICAL CONSTRUCTION**—of aluminum throughout; panel and cabinet are ¼" thick (cabinet is dural.); sub-chassis is ⅛" and spaced off the panel by studs to simplify servicing; all components are fastened to sub-chassis.

**ELECTRICAL CONSTRUCTION AND CIRCUIT**—Series 200A utilizes the finest components throughout and carries a two year guarantee. The circuit is a stable plate circuit rectifier. No diode input tube is used. The plate circuit rectifier type makes available higher input impedance at all frequencies. No shortening of input probe is required for zero adjustments. All zero adjustments are made once and remain constant. A panel adjuster is available to make the unit usable without heating up time. All filament and plate voltages are transformer and tube regulated.

**BUILT-IN CALIBRATION VOLTAGE**—All units have a jack which produces a constant 6.3 volts for standardizing. This is the regulated filament voltage. The sensitivity can be adjusted without tools in the event tubes are replaced in the field. The Series 200A will operate satisfactorily from any source of voltage from 95 to 130 volts ac. Line voltage surges are not observable during use.

**SIZE**—14"H x 9½"W x 7½"D. Guaranteed 2 years. Price \$170.00 F.O.B. Chicago.

## Televiso Products Inc.

7466 IRVING PARK ROAD

CHICAGO 34, ILLINOIS

corrosive fumes. Recent tests by the manufacturer consisted of a 3-min spraying of the selenium rectifiers with a 20 percent salt solution at 55 deg C, followed by a 3-min air blast at 55 deg C, the cycle being repeated continuously throughout the entire 100-hr test. A strong ultra violet light was continuously played on the rectifiers during the length of the test. Results showed no corrosion nor variation in electrical characteristics. The illustration shows the rectifiers suspended in a salt-spray testing tank.

### Medium-Duty Power Switches

CENTRALAB'S new "J" switch series for power applications for transmitters are in production and will be available from stock, in one to five sections, with shorting or non-shortening type contacts. In addition to complete units, sections and indexes will be available separately for individual assembly in any de-

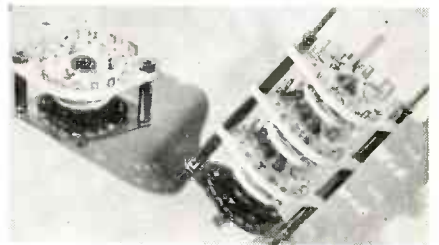

sired combination. All units will be furnished with adjustable stops for limiting the desired number of positions. Switches will have single-hole bushing mounting, with tie-rod extensions to act as locating keys and for additional support in mounting. Bulletin No. 185 is available. 900 E. Keefe Ave., Milwaukee 1, Wis.

### Vacuum Tube Voltmeter

A NEW, COMPLETELY universal vacuum-tube volt-ohm-milliammeter is announced by McMurdo Silver Co., 1240 Main St., Hatford, Conn. The instrument is called "Vomax" and has 12 d-c voltage ranges (0.05 through 3000 volts) at input resistances of 50 and 125 megohms. Six a-c voltage ranges cover 0.05 through 1200 volts, all at 6.6 megohms and 8µmf input loading. Three of these ranges are calibrated -10

# Specify C-D MICABOND



The power that drives a Diesel Locomotive is Electricity! Electricity generated by huge Diesel Driven Generators . . . generators that depend on C-D MICABOND insulation to stand the high heat and vibration of continuous operation. The small armature illustrated separately is used in your automobile generator . . . it too must give long dependable service . . . furthermore it must also be economical to produce so it is built on a fast moving assembly line. Accuracy in dimensions is essential in both these uses of C-D MICABOND insulating rings and segments . . . first to insure unflinching service; secondly to facilitate fast economical assembly.

KW-45

**F**OR dielectric properties and heat resistance that will provide the stamina needed to drive giant locomotives . . . for accuracy in dimensions that expedite production on fast moving assembly lines . . . specify C-D MICABOND rings and segments.

C-D MICABOND is Mica in usable forms. MICA splittings bonded together in sheets and tubes from which segments, rings and other shapes are readily and accurately fabricated. Into every shipment of C-D MICABOND goes a half century of C-D "know-how" . . . your assurance that C-D MICABOND is engineered to do the job for which it is specified.

## C-D PRODUCTS

### The Plastics

**DILECTO**—A Laminated Phenolic.  
**DILORON**—A Molded Phenolic.  
**DILECTENE**—A Pure Resin Plastic Especially Suited to U-H-F Insulation.  
**HAVEG**—Plastic Chemical Equipment, Pipe, Valves and Fittings.

### The NON-Metallics

**DIAMOND** Vulcanized FIBRE  
**VULCOID**—Resin Impregnated Vulcanized Fibre.

**MICABOND**—Built-Up Mica Electrical Insulation.

**Standard and Special Forms**  
 Available in Standard Sheets, Rods and Tubes; and Parts Fabricated, Formed or Molded to Specifications.

### Descriptive Literature

Bulletin GF gives Comprehensive Data on all C-D Products. Individual Catalogs are also Available.

### DISTRICT OFFICES

NEW YORK 17 • CLEVELAND 14 • CHICAGO 11  
 SPARTANBURG, S. C. • SALES OFFICES IN PRINCIPAL CITIES

WEST COAST REPRESENTATIVES  
 MARWOOD LTD., SAN FRANCISCO 3

### IN CANADA:

DIAMOND STATE FIBRE CO. CF CANADA, LTD., TORONTO 8

# Continental - Diamond FIBRE COMPANY

Established 1895..Manufacturers of Laminated Plastics since 1911—NEWARK 16 • DELAWARE

MODEL 200-B

# POWER SUPPLY

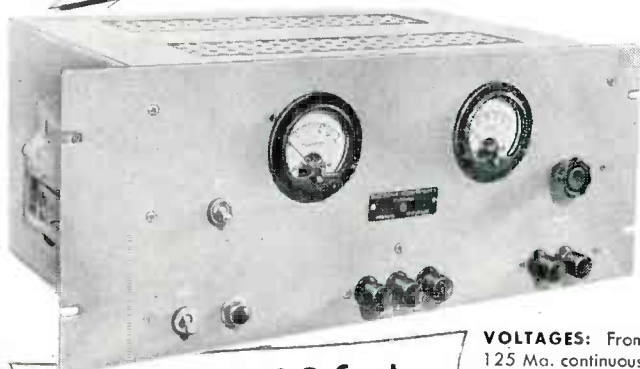

continuously  
variable  
voltage  
plus  
regulation

**0-325 VOLTS D.C. at  
125 MA. Without Switching**

Due to its flexibility and ease of operation the Model 200-B Power Supply has a wide variety of applications in the laboratory and on the production line. Write for descriptive technical bulletin.

**VOLTAGES:** From 0-325 Volts D.C. at 125 Ma. continuously variable. 6.3 Volts A.C. at 6 Amps. center tapped

**REGULATION:** Within 1% for voltages between 20-325 volts from no load to full load.

Within 2% at 10 volts from no load to full load.

**HUM VOLTAGE:** Less than 10 millivolts including noise.

**METERED OUTPUT:** Voltmeter and Milliammeter included to read output voltage and current.



**ELECTRONIC MEASUREMENTS COMPANY**

RED BANK • NEW JERSEY

QUALITY  
CONTROL

# of MICA



FOR  
EVERY  
RADIO  
ELECTRICAL  
AND  
ELECTRONIC  
USE

For nearly 30 years we have consistently maintained Quality Control over production of fabricated mica parts, including those for the exacting requirements of radio and electronic fields. Close tolerances on dimensional measurements are attained by our use of the most advanced equipment in optical magnification and contour measurement. The raw mica is continuously inspected to assure high dielectric value.

Our entire personnel is trained to be quality-minded, which means ingrained accuracy and integrity. By use of our Incentive System, employees have much to gain by conscientious work. Our thorough Training Program makes it easy for employees to adhere closely to the high standards we demand. We invite discussion of your particular needs.

**FORD RADIO  
& MICA CORP.**

Joseph J. Long, President

538 63rd St.,  
Brooklyn 20, N. Y.

Telephone:  
Windsor 9-8300

Established  
1917

## IN-RES-CO RESISTORS

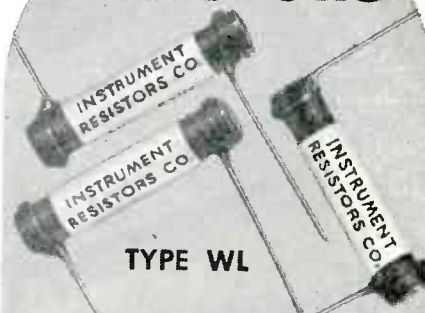

TYPE WL

are specialist-  
wound to  
solve your

# APPLICATION PROBLEMS



Analysis of peace-time requirements indicates a tremendous field for electronic products—and a comparable multitude of production and assembly problems.

The numerous engineering refinements of IN-RES-CO resistors—products of specialized, automatic high-speed winding—are attested to be their wide adoption in communication and control equipment of every description. Type WL, for example, has standard tolerance of 1%, 1 watt rating and a maximum resistance of 15,000 ohms—yet measures only 1" long and 3/16" in diameter.

IN-RES-CO resistor components—meter shunts, multipliers, chokes and solenoids—represent an all-inclusive line. The new 18-page catalog will be sent to you free on request on company letterhead; write today.

## INSTRUMENT RESISTORS CO.



25 AMITY STREET  
LITTLE FALLS, N. J.



through +50 db for power output measurements. Six d-c ranges facilitate measurements from 50 mi-

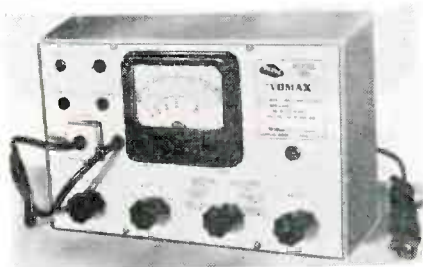

croamperes through 12 amperes. Six zero-left resistances ranges cover 0.2 ohms through 2000 megohms. The a-c response is flat to 5 per cent over the range of 20 cycles to above 100 Mc. One zero-set knob serves for all ranges and need be set but once for all 39 ranges. The instrument has only five different scales on the 4½-in. meter. All circuits are dual-tube, automatically balanced against line voltage variation and tube aging. A removable diode r-f probe is used in the instrument.

### Limits Bridge

MODEL 81 LOW-RANGE limits bridge is self-contained and is one of a series of units for the rapid comparison of large quantities of resistors having comparable values. It is manufactured by Associated Research, Inc., 231 S. Green St., Chicago 7, Ill. The unit is capable of testing resistance values up to



2000 pieces an hour, and any item that offers ohmic resistance to flow of current can be tested. The instrument is battery operated and extremely flexible. The overall adjustable range is from ¼ ohm to 10,000 ohms. Sensitivity control range is from plus or minus ¼ per cent to plus or minus 10 per cent. The unit measures 8x8x12 in. and weighs 18 lb.

# SPECIALLY DESIGNED POWER TRANSFORMERS

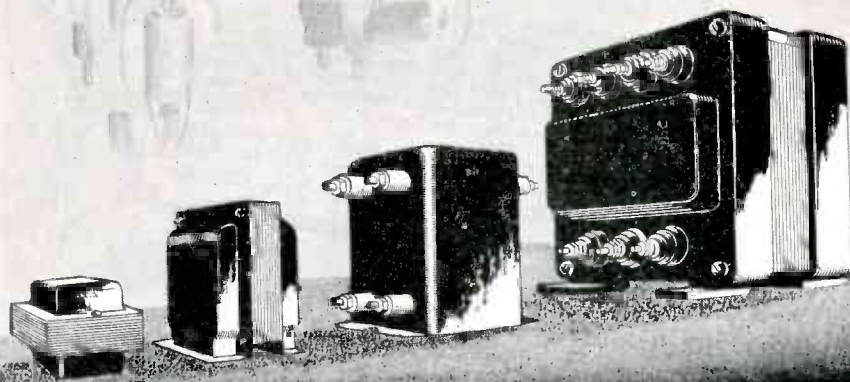

## FOR THE ELECTRONIC INDUSTRY

AUDIO INPUT  
VIBRATOR POW  
CHOKES - AUDI  
INSTRUMENT TR  
CONTROL TRANS  
FLUORESCENT BA

Chicago Transformer has always devoted its engineering and manufacturing facilities primarily to the design and production of Power and Audio Transformers, Filters and Chokes, to fill the specialized needs of the Electronic Industry. If you have a particular problem, let us be of service.

FORMERS  
FORMERS  
FACTORS  
UTO &  
FILTERS  
COILS

## CHICAGO TRANSFORMER

DIVISION OF ESSEX WIRE CORPORATION

3501 WEST ADDISON STREET

CHICAGO, 18



TRADE MARK REG.



ANOTHER  
SPECIAL BY  
PROGRESSIVE



ACTUAL  
SIZE

ENLARGED FOR DETAIL

**CATALOG SHOWS DOZENS MORE**

Special heads, threads and finishes on any metal or alloy adapted to cold upset. Weekly output: 25,000,000 pieces. Many specials, suggesting production savings for you, illustrated in latest catalog. Includes weights per 1M standard pieces, dec. equivs. of fractions, other purchasing and engineering helps. Write for Catalog 18.

**The PROGRESSIVE MFG. CO.**  
50 NORWOOD ST. TORRINGTON, CONN.

★ BUY MORE WAR BONDS ★

Engineered and built by

*Doolittle*



**FM and AM  
FREQUENCY  
MONITORS**

*Direct reading. No charts or complicated calculations necessary. Models available for 110 volt A.C. or battery operated portable use. Meet FCC requirements.*



**DISTORTION  
METER**

*Direct reading device which indicates as a percentage of the fundamental frequency, the square root of the sum of the squares of the harmonic components. It is used for audio frequency measurements in any audio device in the usual range of voice or musical notes from 150 to 15,000 cycles.*

• Utilize the many advantages of these units now. They are sturdily built, self-contained, moderately priced. Remember . . . equipment pioneered by DOOLITTLE years ago, *still serves efficiently today!*

SEND FOR FULL DETAILS

*Doolittle*

**RADIO, INC.**

7421 SOUTH LOOMIS BOULEVARD  
CHICAGO 36, ILLINOIS

**BUILDERS OF PRECISION  
RADIO EQUIPMENT**

**AMPERITE**

THERMOSTATIC METAL TYPE  
**DELAY RELAYS**  
PROVIDE DELAYS RANGING  
FROM 1 TO 120 SECONDS

**Other important features include:—**

1. Compensated for ambient temperature changes from  $-40^{\circ}$  to  $110^{\circ}$ F.
2. Contact ratings up to 115V-10a AC.
3. Hermetically sealed — not affected by altitude, moisture or other climate changes . . . Explosion-proof.
4. Octal radio base for easy replacement.
5. Compact, light, rugged, inexpensive.
6. Circuits available: SPST Normally Open; SPST Normally Closed.

**WHAT'S YOUR PROBLEM?** Send for "Special Problem Sheet" and Descriptive Bulletin.

**AMPERITE CO.** 561 BROADWAY  
NEW YORK 12, N. Y.

In Canada: Atlas Radio Corp., Ltd.  
560 King St. W., Toronto



with  
porcelain  
heater

with heater wound  
directly on blade

## Fluorescent Tube Achievement

LAMP ENGINEERS who developed the circle of light known as the circline fluorescent tube topped off their achievement by making both ends meet with a 4-pin plastic base (at top of lamp.) The new base is

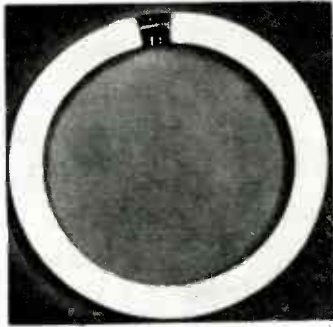

shown on the 12-in. ring, the medium-sized member of the family of three circlines which the Westinghouse Lamp Div., Bloomfield, N. J. will offer as soon as wartime manufacturing conditions permit. This base, about 1 in. in diameter, contains two pins from each of the two connecting ends of the lamp. For convenience in installation the pins are mounted at a 45-deg angle to the plane of the circle.

## Recording Densitometer

DESIGNED TO READ densities from zero to 4.0, this instrument is particularly useful for speedily detecting variations in photographic or radiographic film. However, the principle of operation can be utilized in any field where variations in the subject can be detected by elec-



tronic apparatus. The densitometer computes a true logarithmic graph of its findings. The instrument was designed and built by the Electrical Research Div. of Western Electric Co. and Leeds and Northrup Co. to meet specification requirements developed by Triplet and Barton, Inc., Burbank, Calif.

ELECTRONICS — August 1945

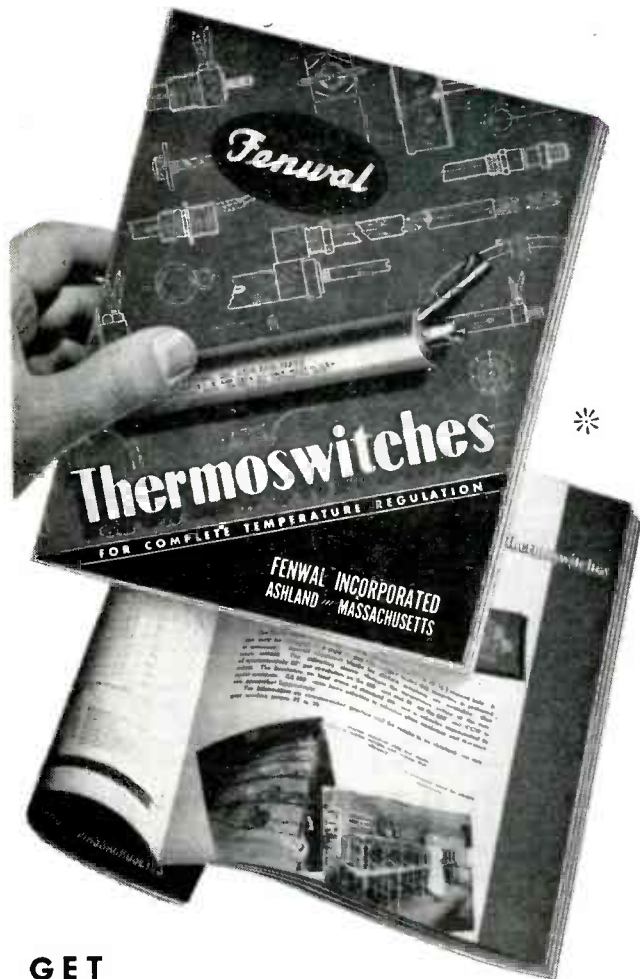

GET  
THIS VALUABLE BOOK  
On Temperature Control

**FREE**

### TO AIRCRAFT DEVELOPMENT ENGINEERS

Before deciding on temperature regulating devices for your products, be sure to investigate Fenwal Thermoswitches. They operate on an unusual principle, and offer many advantages not found in other types of switches. The Fenwal Engineering Data Book contains detailed drawings of construction of various models and typical installations.

"IF IT'S A FENWAL — IT'S THE BEST OF ALL"

- Compact construction permits installation in tight places.
- Make and break unaffected by external vibration.
- Readily adjustable for wide range of temperature control.
- Minutely accurate.
- Adaptable for all types of media.
- Inexpensive.

• A 44-page treatise on Thermal Control including installation drawings, photographs, blueprints and descriptive suggestions for future planning with basic principles involved in temperature regulation and control. . . . Just write for your free copy on your business letterhead.

THERMOSWITCHES  
**Fenwal**, Inc.  
FOR COMPLETE TEMPERATURE CONTROL  
43 Pleasant Street, Ashland, Massachusetts

"KURMAN SENSITIVE" OF 1930 - STILL THE BEST

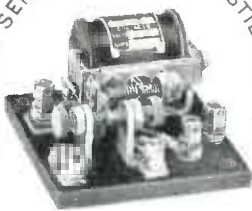

## New Features added to KURMAN RELAYS

Microphone  
Hummer  
Type Z-7200

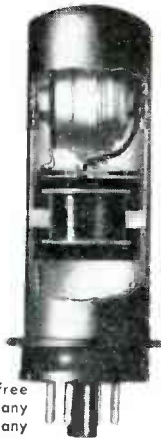

### The Well-Known KURMAN SENSITIVE RELAY

the first to demonstrate the superior magnetic properties of hydrogen-annealed nickel alloy 15 years ago — again introduces an outstanding new feature:—

#### CHATTERLESS OPERATION

— obtained through cushioning of contacts in an energy absorbing material. This feature enables keying up to 150 words p. m. Mica insulation of the armature makes the relay suitable for keying 50 m. c. RF signals.

#### 25 YEARS' EXPERIENCE.

a thoroughly competent staff of Development and Design Engineers, and complete manufacturing facilities are at your service when you submit your Relay problems to us.

Write for details on:

- KURMAN LINE OF RELAYS
- KURMAN VIBRATOR CONVERTERS
- KURMAN MICROPHONE HUMMERS

For trouble-free operation in any climate and at any desired altitude,

#### HERMETICALLY SEALED

relays are available, either of plug-in type or equipped with solder lugs. Some of these relays take as little space as 2" x 1 1/4" dia., and have up to 10 amps current capacity due to the special atmosphere introduced into the container under pressure.

**KURMAN ELECTRIC CO.**



35-18 37th STREET • LONG ISLAND CITY I, N. Y.

**INVESTIGATE**

*Franklin's* **39**

**RADIO SOCKET**

The favorite yesterday, the favorite for tomorrow

**NORMAN H.**

**LAWTON**

Engineering • Sales • Service  
1775 Broadway, New York City, 19  
Phone Circle 6-0867

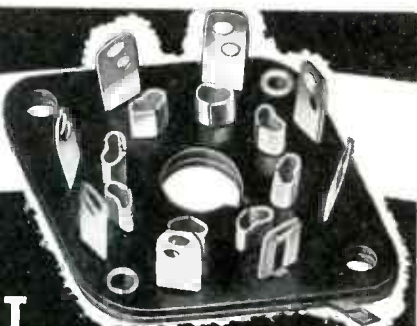

Note—Ground Tab

Illustrating the "U" shaped bow spring action contacts...39H and 39G...used in Franklin's series 39 Sockets.

Raw spring action maintains resistance even after installation of oversize pins

Directional metal grain prevents breaking of soldering tool and permits rough handling in production



"U" shaped contact provides separate soldering tool which prevents solder from flowing into contact body



The 39G contact has a soldering tab to eliminate wiring to ground...can be inserted in any position where grounding is desired.

- A W FRANKLIN MANUFACTURING CORPORATION Sockets... Terminal Strips... Plugs... Assemblies
- F W SICKLES COMPANY Coils... I. F. Transformers... Antenna Loops... Trimmer Condensers, mica and air dielectric... Tuning Units
- ELECTRO MOTIVE MANUFACTURING COMPANY Molded Mica Capacitors... Mica Trimmer Capacitors

**Hard to Get? HARRISON has it!**

Harrison usually has for immediate delivery, appropriate stocks of critical Electronic Parts and Equipment

### RACK CABINETS

8 3/4 to 77" panel space. Also a complete stock of chassis, panels, rack accessories and smaller steel cabinets.



### HALLICRAFTERS S-39 PORTABLE RECEIVER

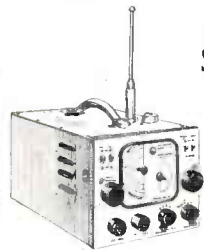

AC—DC—Battery  
9 tubes, 540  
KC to 30.5 MC  
\$110 complete.

### MULTIMETERS

Triplet 1200-E  
SUPREME 542  
TRIPLER 666-H  
RCA 195 Volt Ohmyst.



### FUSES

8AG — 3AG — 4AG



Moderate quantities of all stock current ratings. Also Holders and Extractor Posts.

### CONDENSERS MICA — PAPER — OIL ELECTROLYTIC

1 MMF to  
4000 MFD  
6 Volt to  
25 kilovolt



A copy of our  
**MASTER  
BUYERS  
GUIDE**

FREE to those associated with priority purchasing.

Harrison service is the byword of the Electronic Industry — Serving faithfully since 1925

**HARRISON**  
RADIO CORPORATION  
12 WEST BROADWAY • NEW YORK CITY 7  
BARCLAY 7-9854  
JAMAICA BRANCH — 172-31 Hillside Ave. — KENYON 9-4102

## Transformer Cases

A NEW LINE of standard size transformer cases is available in quantity. Sizes range from  $1\frac{1}{2} \times 1\frac{1}{2} \times 2\frac{1}{2}$  to  $5\frac{1}{2} \times 4\frac{1}{2} \times 6\frac{1}{2}$  in. They can be furnished with or without studs,

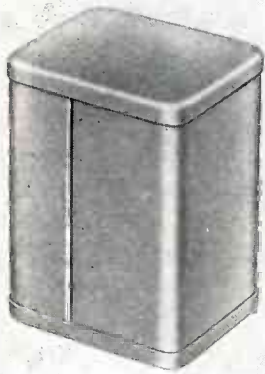

pierced covers, brackets or channels. Olympic Tool & Mfg. Co., Inc., 39 Chambers St., New York 7, N. Y.

## Portable Kilovoltmeter

A NEW ADDITION to the line of portable kilovoltmeter made by the Shallcross Mfg. Co., Collingdale, Pa., is known as No. 759. This instrument has 5 ranges that provide 1, 2, 5, 10 and 20 kilovolts d.c. at full scale. The accuracy of the built-in meter is plus or minus 2 percent. Several new features are incorporated in this instrument.

## Vacuum Tube Voltmeter

SERIES NO. 200-A vacuum-tube voltmeters for voltage measurements are accurate and stable within the range of 7 cps to 500 Mc. The lowest readable voltage is 0.05 volt on a



maximum scale range of 0.5 volt. Five voltage ranges (0.5, 2, 15, 50 and 150) are spread full scale on a  $4\frac{1}{2}$ -in. meter dial. Accuracy of readings are 2 percent full scale; middle scale accuracy is rated 5

*A New Impregnating Service*

Which... **PROTECTS STEATITE CERAMIC PARTS AGAINST MOISTURE ABSORPTION AND FUNGUS ATTACK . . . . .**

by the use of  
**DOW-CORNING FLUID #200**

This new method for waterproofing ceramic surfaces results in increased electrical resistance and improved performance of equipment under conditions of high humidity and condensation. Application of Dow-Corning Fluid No. 200 to ceramic bodies coats them with an extremely thin film of silicone. It will adhere effectively even when immersed for days in sea water and does not collect dust or corrode metals; nor will it react with organic materials. It has a power factor of the order of .005% and is effective up to 150°C. It also acts as a neutral flux for soldering, and is not removed by contact with organic solvents. For further applications and engineering data write or phone.

*Other Services:*

- DEHYDRATING
- DIPPING
- IMPREGNATING
- CENTRIFUGING
- SPRAYING
- POLISHING

**PRODUCTION ENGINEERING CORP.**

666 VAN HOUTEN AVENUE, CLIFTON, N. J. • TEL. PASSAIC 2-5161

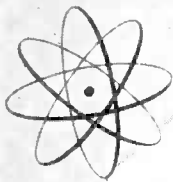

## REGULATED POWER SUPPLY

180-300 volts Type PS-2

For a simple, efficient, economical power supply to replace messy, space-consuming, expensive batteries install a modern G-E Regulated Power Supply. Extremely useful where d-c power is required to operate electronic devices in research or industry. Provides a stable d-c voltage regardless of moderately large or rapid changes in the a-c supply voltage. Other regulated power supplies available in various ranges. Write today: *Electronics Department, General Electric, Syracuse, New York.*

**Electronic Measuring Instruments**

**GENERAL ELECTRIC**

164-D6



NOS. 0000, 000, 00 AND 0

ARE *Big* PRODUCTS

— big in their importance to the manufacture of precision instruments, for they are the *almost infinitesimal* screws that are used in the assemblies of many of the world's finest mechanical masterpieces.

# PyroFerric

## IRON CORES



Pyroferric powdered metal cores have kept apace the vital precision instrument development. They are manufactured to specification:

"Q"

HIGH  
as desired FREQUENCY  
LOW

HIGH  
MEDIUM  
LOW

Consult Pyroferric on your Powder Metallurgy requirements

# PYROFERRIC Co.

175 VARICK STREET NEW YORK, 14, N.Y.

For more than half a century Waltham has specialized in the production of *precision* screws. Its plant and equipment have steadily modernized and expanded to meet the demands of every period of business development and the exacting needs of three wars.

Waltham is tooled to produce fine screw machine products *for a million uses* — any thread, material or finish — any type head, from 1/64" to 1 1/2" diameter.

America's Outstanding Producers of Fine Instrument Screws

Send for catalogue for complete data

## WALTHAM SCREW

COMPANY  
75 Rumford Ave.  
Waltham, Mass.

percent or better. The voltmeter has a detachable probe and built-in calibration voltage. The instrument measures 14 x 9½ x 7½ in. Televiso Products, Inc., 7466 Irving Park Rd., Chicago 34, Ill.

### Radio and Wire Recorder Combination

A COMPLETE RECORD of a concert presented in Carnegie Hall, New York City, was recorded on wire by a demonstration model of a Lear home radio and wire recorder combination. Lear states that the recording of this concert required no special apparatus or arrangements. The music was picked up by regular microphones and readily recorded. The recorder is designed to overcome difficulties of continuous recordings, need for technical training or adjustments for purposes of recording. Lear Inc., 230 E. Ohio St., Chicago 11, Ill.



### Snap Switch

ROBERT HETHERINGTON & Son, Inc., Sharon Hill, Pa., have available a snap switch which they call "Junior" and which measures ½ x ¾ in. overall. Though complete in itself, it can be furnished with special over-travel adapters and special mounting sockets. A pressure of 4 lb is required to operate Junior. It comes supplied normally open, normally closed, 2 circuits or spdt.

### Velocity Microphone

TYPE 808 is an improved microphone and is rated 40,000 ohms impedance, for operation direct to grid of tube; frequency response 40-10,000 cps; output level 63 db

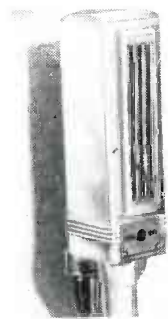

below 1 volt per bar. It weighs about 2 lb. The sensitive element consists of a thin 5-millimeter rib-

## How to Keep a Signal... *"BUSY"*

"Land here!" "Patrol there!" "Base deflection—Right 321!" These are the "busy" signals of warfare. And it's the job of the Signal Corps to keep these vital communications crackling back and forth with a minimum of delay.

Their task is made easier because of the design and manufacturing skill behind the equipment in use today. Look at the receiver cases of INSUROK, molded to close tolerances by Richardson for the Rola Company, Inc., Cleveland, Ohio. These cases contain the delicate hearing mechanism of headsets made by Rola for use by our armed forces everywhere.

Notice the inserts, threads and holes in the cases illustrated. This is precision molding... all done in one operation... and is typical of the work we do daily with INSUROK for a wide variety of intricate industrial applications. If your product... present or planned... calls for the use of a moisture-resistant, lightweight, dielectrically and mechanically strong plastic part—write Richardson Plastics today for the full story about INSUROK—Molded and Laminated!

# INSUROK *Precision Plastics*

## The RICHARDSON COMPANY

MELROSE PARK, ILL. NEW BRUNSWICK, N. J. FOUNDED 1888 INDIANAPOLIS 1, IND. LOCKLAND, CINCINNATI 15, OHIO  
 DETROIT OFFICE: 6-252 G. M. BUILDING, DETROIT 2, MICHIGAN NEW YORK OFFICE: 75 WEST STREET, NEW YORK 6, N. Y.  
 CLEVELAND OFFICE: 326-7 PLYMOUTH BLDG., CLEVELAND 15, OHIO

Laboratory Standards



# PULSE GENERATOR

MODEL 79-3

**SPECIFICATIONS:**

- FREQUENCY:** continuously variable 60 to 100,000 cycles.
- PULSE WIDTH:** continuously variable 0.5 to 40 microseconds.
- OUTPUT VOLTAGE:** Approximately 150 volts positive
- OUTPUT IMPEDANCE:** 6Y6G cathode follower with 1000 ohm load.
- R. F. MODULATOR:** Built-in carrier modulator applies pulse modulation to any r.f. carrier below 100 mc.
- MISCELLANEOUS:** Displaced sync output, individually calibrated frequency and pulse width dials, 117 volt, 40-60 cycles operation, size 14"x10"x10", wt. 31 lbs

Price: \$275.00 F.C.B. BOONTON

Immediate Delivery



Master some new uses of electronics in:

- transmission lines
- antennas
- wave guides

A working reference on some of the latest uses of electronics to be released from necessary wartime restrictions—an expert guide to the newest uses of electronics in transmission lines, antennas and wave guides, with a special section on wave propagation, which covers the basic principles of radio transmission. Definitions, formulas, diagrams, equations, tables, practical working facts—here are all the data and explanations you need to make full use in your work of the latest information available.

**Just Published!**

## TRANSMISSION LINES ANTENNAS AND WAVE GUIDES

By **Ronald W. P. King**

Associate Professor of Physics and Communication Engineering, Harvard University

**Harry Rowe Mimmo**

Associate Professor of Physics and Communication Engineering, Harvard University

and **Alexander H. Wing**

Lecturer on Electronics, Harvard University; on leave from the School of Technology of the College of the City of New York

347 pages, 6 x 9, 134 figures, \$3.50

With an intensive review of theory and applied use, the book presents transmission lines from the high-frequency point of view, and antennas from the point of view of electromagnetic theory. All explanations are based on the fundamental laws of general electro-dynamics.

Look over these sections:—

### TRANSMISSION LINES

Nonresonant Lines. Transmission-Line Constants. Dissipationless Transmission Lines. Impedance Matching. Impedance Matching by Means of Stubs. Circle Diagram. General Transmission-Line Equations.

### ANTENNAS

A Qualitative Introduction to General Electromagnetic Theory. The Driven Antenna as a Circuit Element. Coupled Antennas and Transmission Lines. The Receiving Antenna as a Circuit Element. Electromagnetic Field of Antennas and Arrays. Closed Circuits as Antennas.

### ULTRA-HIGH-FREQUENCY CIRCUITS

Classification of Circuits. Transmission Circuits. Transmitting and Receiving Systems Using Nonresonant Circuits. Resonant Circuits.

### WAVE PROPAGATION

**See it 10 days • Send coupon**

McGraw-Hill Book Co., 330 W. 42nd St., N. Y. C. 18  
Send me King, Mimmo and Wing's TRANSMISSION LINES, ANTENNAS AND WAVE GUIDES for 10 days examination on approval. In 10 days I will send \$3.50, plus few cents postage, or return book postpaid. (Postage paid on cash orders.)

Name .....  
Address .....  
City and State.....  
Company .....  
Position ..... L. 8-45

**Carter**

## FIRST TO POWER 100 WATT MOBILE TRANSMITTER

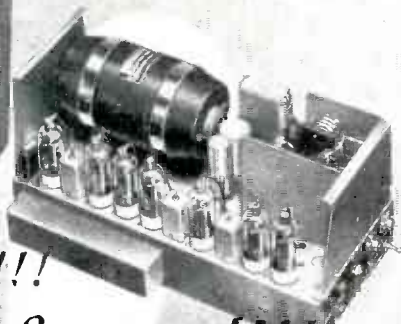

*It's New!*

*It's Powerful!!*

*It's Carter Equipped!!!*

That's the Kaar Engineering Company's recently developed 100 Watt FM Mobile Transmitter.

CARTER Rotary Products provide unequalled performance and dependability for all types of mobile communication equipment.

Latest catalog and trade bulletin sent upon request.



**Carter Motor Co.**  
*Chicago, Illinois*

1606 Milwaukee Ave. Carter, a well known name in radio for over twenty years. Cable: Genemoter



bon, powered by 4 rugged magnets for added field strength and dependability. Sound pickup at the sides of the mike is negligible. Its bi-directional response makes the unit suitable for use with stage presentations, orchestras, recording purposes and indoor p-a systems. Universal Microphone Co., Inglewood, Calif.

### Surface Analyzer Accessory

THIS ACCESSORY, designated Rough-Finish Measuring Head, makes a perfect complement for the original Brush surface analyzer. It checks the rougher surface finishes and waviness in metals, glass, plastics, plated and painted materials and is particularly useful on turned sur-

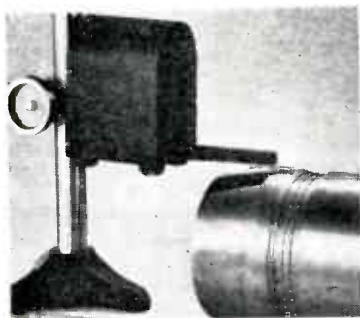

faces. The pickup and drive head accurately measures irregularities from 100 to 3,000 microinches, peak to valley. The accessory extends the use and range of the original surface analyzer from 1 to 3,000 microinches. The Brush Development Co., Cleveland, Ohio.

### Capacitors

CENTRALAB (900 E. Keefe Ave., Milwaukee, Wis.) announces controlled-temperature capacitors which are available in any desired temperature coefficient between  $-120$  and  $-4000$  parts per million per deg C. The range from  $-750$  to  $-4000$  parts per million is new and has the same accuracy of temperature compensation curve and uniform electrical characteristics as present standard ranges, though the new ceramic bodies have somewhat higher dielectric constants and thus provide higher values of capacitance in the same size tube.

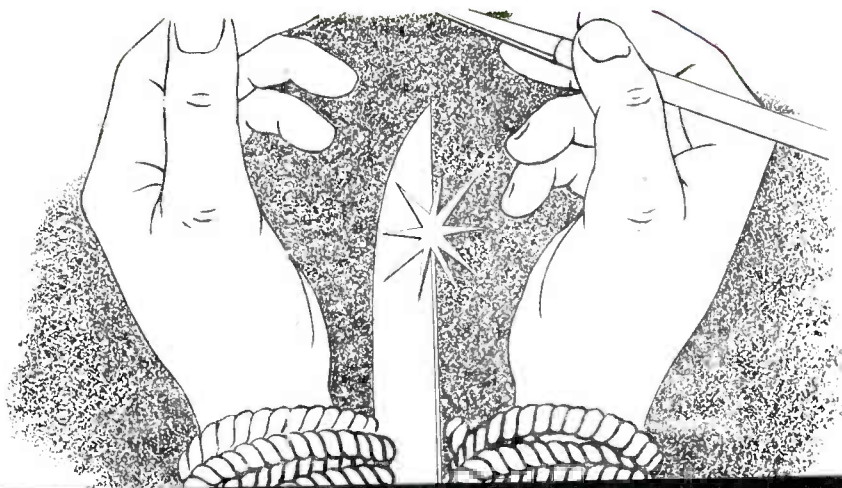

## WALKER-TURNER FLEXIBLE SHAFTING

*Gives Your Designers a Free Hand*

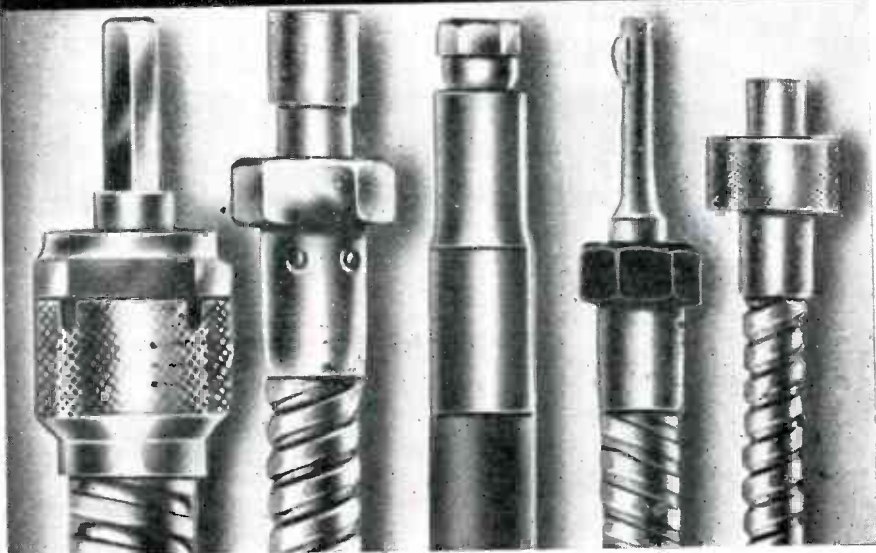

Complicated gear systems often cramp a designer's style. Frequently, it is practicable to replace them with Walker-Turner Flexible Shafting in applications involving remote control or the transmission of light power loads. Result: lighter, simpler, more compact assemblies!

Every step in the design and manufacture of Walker-Turner Flexible Shafting is directed toward producing smoother power flow and more sensitive control. And we have been doing it for many years—in manufacturing our own flexible shaft machines and in helping other manufacturers solve their flexible shafting problems.

*Write today for our latest catalog.*

**WALKER-TURNER COMPANY, Inc. Plainfield, New Jersey**



## FLEXIBLE SHAFTING

FOR REMOTE CONTROL AND POWER TRANSMISSION

# EISLER EQUIPMENT

..complete and diversified for every phase of electronic\* manufacture!

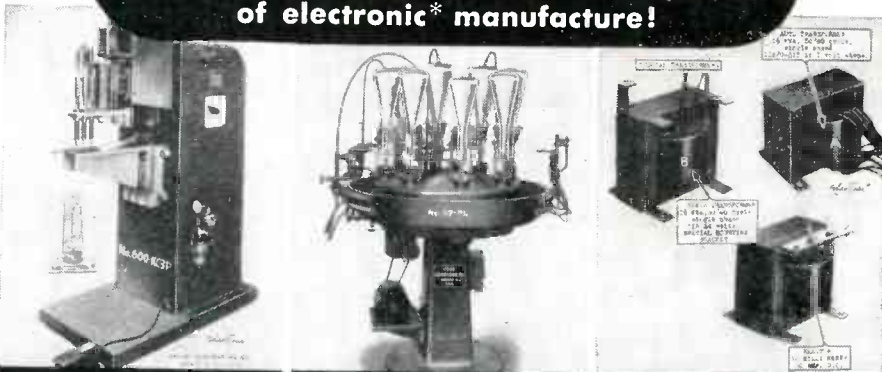

(A) No. 600-KC3P, 50 KVA Press Type Spot Welder, 3 Spots, Air Operated, 18" Throat—a high production unit.

(B) No. 57-8L New Eisler 8 head type Tipless Sealing Machine. Adaptable for all types and sizes of bulbs.

(C) EISLER Special Transformers and Reactors—high or low voltage; air cooled, oil immersed or uncased.

The CHAS. EISLER line of specialized electronic tools, machines and devices is complete and diversified. Included are innumerable types of welders—spot, seam, butt, rocker, arm, pneumatic and special types. Also included are hundreds

of devices for vacuum tube manufacture—glass tube cutters, slicers, stem and sealing machines as well as an all-inclusive line of transformers for every industrial and general need.

\* EISLER serves 99% of American vacuum tube producers today. Write for completely illustrated catalog.

## CHAS. EISLER EISLER ENGINEERING CO.

751 SO. 13th STREET (Near Avon Ave.) NEWARK, NEW JERSEY



Consumers don't want  
"PLUG-UGLY" appliances

... use

**ELECTRIX**  
SOFT-RUBBER PLUGS

**ELECTRIX**

Corporation

140-158 MIDDLE STREET  
PAWTUCKET, RHODE ISLAND

UNITED STATES RUBBER COMPANY  
Exclusive Selling Agents



# SPECIAL PRECISION FRACTIONAL HORSE-POWER MOTORS AND GENERATORS

## HOW THEY ARE USED

It was our plan to publish a booklet showing many of the interesting uses for fractional horse-power motors and generators, complete with photographs and schematic drawings—thought-provoking information for engineers planning their post-war products. So, we wrote our many customers and asked for information along those lines. Here is a typical reply:

"I have your letter in which you requested information regarding the use of "ELINCO" products. While I can attest to the excellence and reliability of your products, unfortunately I cannot at this time describe any specific application of such units because of the nature of my work. During the past several years all the work I have done has been of a confidential nature, and one cannot easily describe the application of your products without revealing the nature of the device."

Obviously, we have had to postpone our booklet. However, as soon as official release can be obtained to describe the many fascinating applications of our products, we will publish our booklet, a copy of which will be yours for the asking.

In the meantime, we will welcome descriptions of uses of fractional horse-power motors and generators, if they can be released, and will be delighted to place your name on our mailing list for "Fractional H.P. Motors and Generators . . . and How They Are Used" when we are able to publish it.

the  
electric  
indicator  
co.

109 Parker Ave. Glenbrook, Conn.

SPECIALISTS IN THE DESIGN AND PRODUCTION OF SPECIAL PRECISION FRACTIONAL HORSE-POWER MOTORS AND GENERATORS

## Literature

**Indicating Instruments.** Marion Electrical Instrument Co., Manchester, N. H. have issued a 12-page brochure which explains the history, uses and advantages of their glass-to-metal hermetically-sealed 2½ and 3½-in. electrical indicating instruments.

**Quartz Crystals.** The technical and manufacturing resources of Beaumont Electric Supply Company (1319 S. Michigan, Chicago, Ill.) in the manufacture of piezo-electric quartz crystals are illustrated and described in a 16-page brochure entitled "Quartz Crystals for Frequency Control."

**Radiator Performance.** "Amperex Radiator Performance" is the title of a short informative article which provides comprehensive data on the actual cooling performance of Amperex radiators which are used on forced air-cooled copper anode tubes employed in radio transmitters and industrial electronic heaters. Amperex Electronic Corp., 25 Washington St., Brooklyn 1, N. Y.

**Capacitor Nomograph.** This pulse service capacitor nomograph (Technical Bulletin No. 11) is primarily designed for determining the volt-amperes through a capacitor used in rectangular pulse service, but as an intermediate step it finds the d-c (unit pulse) energy content, which may be sufficient. Sprague Electric Co., Engineering Dept., North Adams, Mass.

**Insulation Tester.** The Midget "Megger" for testing insulation resistance is now being manufactured in the United States by James G. Biddle Company, 1211 Arch St., Philadelphia 7, Pa. Bulletin No. 1785 describes the instrument.

**Electrical Components.** "Alden's Blue Book of Electrical Components" consists of loose-leaf sheets which inform the reader about electrical components, facsimile equipment and services and facilities of Alden Products Co., 117 N. Main St., Brockton 64, Mass.



### MAKE A TEST...

for transparency and surface qualities, and to prove perfection in the base fabric. No pinholes, weaver's marks or variations in density!

### SET MIND AT REST...

about whether your drawings will blueprint clear and sharp in every detail . . . whether they'll defy time and handling. They will!



### THERE'S JUST ONE "BEST"...

We put superior quality into Arkwright Tracing Cloths years ago. We've maintained uniformity in this superior quality ever since. Arkwright Finishing Company, Providence, Rhode Island.



Sold by leading drawing material dealers everywhere



# Arkwright

## TRACING CLOTHS

AMERICA'S STANDARD FOR OVER 20 YEARS

# E-I HERMETICALLY-SEALED MULTIPLE HEADERS

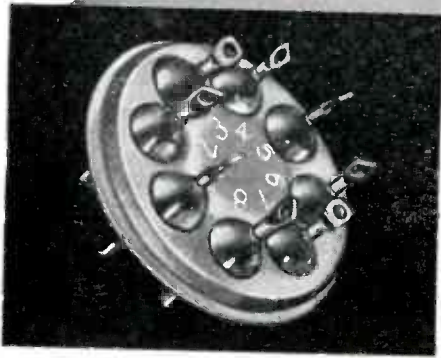

- ★ VACUUM TIGHT SEAL
- ★ KOVAR METAL ELECTRODES
- ★ PYREX GLASS BEAD
- ★ MANY STANDARD TYPES
- ★ ANY TYPE TO SPECIFICATIONS
- ★ SOLDER OR WELD EASILY

A complete and diversified line of E-I 4, 5, 6, 7 and 8 electrode hermetically sealed Multiple Headers are now available as standard stock items. All are supplied at mass production prices—no special tool or die costs involved. Individual sealed terminals are also included in a wide variety of standardized types. All special shapes or forms can be supplied to exact specifications at slightly higher cost.

All include Pyrex glass bead—immune to thermal or electrical shock. Pyrex annealed to eliminate strain. Kovar electrode and shell solders and welds easily and forms absolute vacuum tight chemical bond with glass—lead becomes integral part of housing. Multiple Headers can be fabricated in any form to specification—write today.

**E-I INC.**  
**ELECTRICAL INDUSTRIES · INC.**  
42 SUMMER AVENUE, NEWARK 4, N. J.

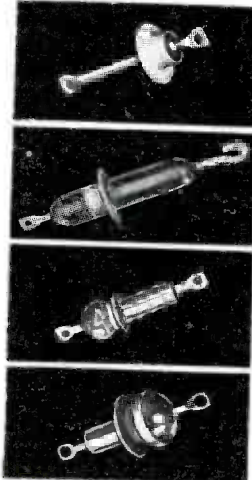

Particular **WASHERS**  
FOR ELECTRONIC PRODUCTS

## Quadriga Quality WASHERS

Precision engineered for standard or special requirements. Flat, Irregular Contour. Finishing, Tension, Cupped and Drawn, Friction, Dished Blanks, etc. Wire terminals.

Prompt delivery any quantity.

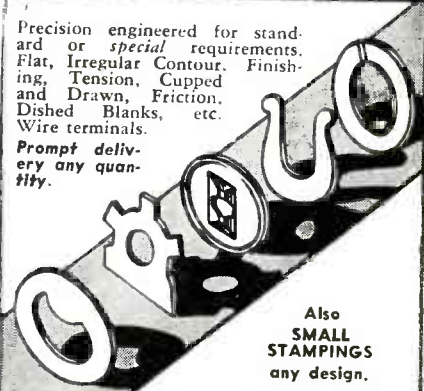

Also  
**SMALL STAMPINGS**  
any design.

Ask for Quadriga Catalog, Photos and valuable washer data. Send specifications for quotation.

The **QUADRIGA MFG. CO.**

Incorporated 1894 "Half a Century"  
221A West Grand Ave.,  
CHICAGO 10, ILL.



## Draftsmen Wanted

Also

## Designers, Detailers, Tracers and Engineers

We are one of the largest manufacturers of a wide variety of communication and electronic equipment in the world, fully prepared and ready to go ahead with a very ambitious, expansion program as quickly as we are permitted. There will be unlimited possibilities for creative, ambitious men to advance to key positions both in research development and production field. At present, we are producing vital equipment for our fighting forces.

**Good Starting Salaries—Exceptionally fine working conditions**

Apply Personnel Office 8 A. M. to 5 P. M.

**FEDERAL TELEPHONE & RADIO CORP.**

The Mfg. unit of the International Tel. & Tel. Corp.

591 Broad St., Newark, N. J.

W M C Rules Observed

## JONES TERMINAL PANELS

Our large variety of Terminals plus special equipment enable us to give unusual service on special Terminal Panels.

Send us a print or description of your requirements and we will promptly submit prices and deliveries. Hundreds of standard Terminal Strips listed in Catalog No. 14. Send for your copy today.

**HOWARD B. JONES CO.**  
2460 W. GEORGE STREET  
CHICAGO 18, ILLINOIS

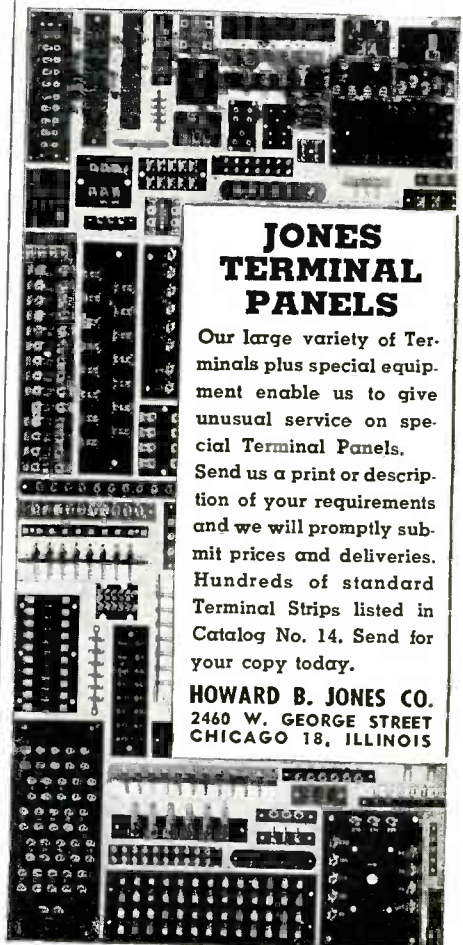

**Electrical Contacts.** A review of basic contact functions, variables and metals and their alloys is contained in a bulletin issued by Callite Tungsten Corp., Union City, N. J. This is a reprint of an article by J. Kurtz, Director of Research, which appeared in an issue of *Electrical Manufacturing*, entitled "Electrical Contacts Based on Many Alloys."

**The Lighthouse Tube.** The theory and development of the Lighthouse tube (disk-seal electronic tube) is contained in publication No. ETR-7. The pamphlet describes the basic principles of design and operation of the tube and its advantages in television, f-m and other fields in the u-h-f spectrum. General Electric Co. Tube Div., Schenectady, N. Y.

**Relays.** Catalog No. 10 gives illustrations, fully detailed specifications, suggested applications and operating data of the most widely used relays, solenoids, magnetic contacts and switch parts manufactured by Guardian Electric Mfg. Co., 1400 W. Washington Blvd., Chicago 7, Ill.

**Recording Apparatus.** The several types of recording apparatus for the recording of pressure, temperature, time (on-off) or any process or reaction is contained in a 28-page booklet released by Gorrell & Gorrell, Chicago Heights, Ill., manufacturers of "Electrix" recording paper.

**Vacuum-Tube and Crystal Rectifiers in UHF.** A recent copy of *The Experimenter*, published by General Radio Co., 275 Massachusetts Ave., Cambridge 39, Mass., contains an article entitled "Vacuum-Tube and Crystal Rectifiers as Galvanometers and Voltmeters at Ultra-High Frequencies."

**Capacitors.** The background, uses and types of capacitors is contained in a 40-page brochure which also has color illustrations depicting the uses of capacitors in war equipment. The brochure is entitled "Solar Capacitors in the War and in the Peace." Solar Mfg. Corp., 285 Madison Ave., New York 17, N. Y.

# AMPLIFIERS INTERCOMMS RECORDERS

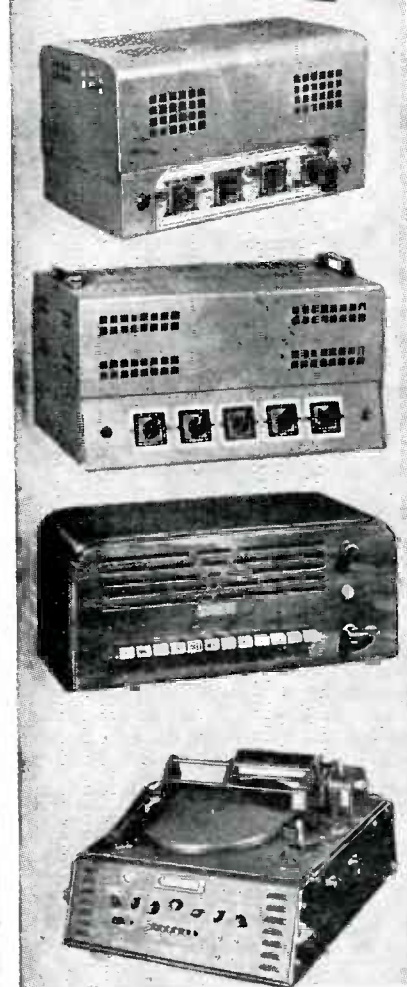

## Write for This Important New CONCORD Presentation

"Sound Equipment"—ready now—a new up-to-the-minute Concord folder illustrating and describing our complete line of Amplifiers, Intercomms and Recorders AVAILABLE FOR IMMEDIATE SHIPMENT.

**Amplifiers**—ranging in output ratings of 17 watts to 75 watts A.C.—also 6-volt units with and without built-in phonograph. Complete listing of speakers, microphones and essential equipment also included.

**Intercommunication Systems**—master and sub-station combinations for every purpose from 2 to 100 stations. Push button control, universal operation, "busy signal" and "call waiting light" features.

**Recording Equipment**—professional type for microphone recording, radio recording, transcriptions, public address.

**Engineering Service**—Our engineering service is at your command, without charge, to answer any and all "Sound Equipment" questions.

Mail the coupon below for your copy of "Sound Equipment" now.

**CONCORD**  
**RADIO CORPORATION**  
*Lafayette Radio Corporation*  
CHICAGO 7, ILL. ATLANTA 3, GA.  
901 W. Jackson Blvd. 265 Peachtree Street

CONCORD RADIO CORP.

901 W. Jackson Blvd., Dept. G-85

Chicago 7, Illinois

Please send me at once copy of your new "Sound Equipment" folder.

Name.....

Address.....

City.....State.....

## ON TOP OF YOUR NEEDS for radio and electronic equipment

Continuous engineering enables BUD to provide you with the latest in radio and electronic equipment. You can fill all your needs for chokes, cabinets, condensers and a multitude of accessory parts . . . save yourself time and trouble . . . by standardizing on BUD completely. See the complete display of hundreds of new items in the NEW Bud Catalog. Write for free copy!



# Star Steatite

has a very desirable low loss factor, making it particularly well suited for radio and television equipment, in addition to which its strength and density make it ideal for many mechanical uses.



## The **STAR** **PORCELAIN CO.**

Electronics Dept.

Trenton 9, N. J.

## KIRKLAND Pioneer INDICATING LAMPS

WHERE QUALITY IS THE  
FOREMOST CONSIDERATION



### THE #659 D/E DELUXE-UNIT OF SUPERIOR DESIGN AND CONSTRUCTION

*Extremely Shallow in Depth  
1 1/4" Behind Front of Panel*

Heavy walled glass lens in a screw type lens-cap, 1/8" thickness hex holding lip, 1 3/8" mounting hole, molded socket with 6/32 screw terminals. For S6 lamps up to 120 volts, lamp easily removed from the front without tool. List Price (less bulb) \$2.20.

WRITE FOR CATALOGUE

**THE H. R. KIRKLAND CO.**  
MORRISTOWN, N. J.

## CUT HOLES FAST



### in radio chassis

No tedious drilling... no reaming... no filing! Saves hours of work. Cuts clean, accurate holes for sockets, plugs, other receptacles. Tool has three parts: punch cuts through chassis, die supports metal and prevents distortion, cap screw is turned with wrench to cut hole. Sizes for holes 3/4" to 3 1/2". For complete information write Greenlee Tool Company, 1928 Columbia Ave., Rockford, Illinois.

WRITE FOR FREE FOLDER S-119 ▶



**GREENLEE**  
FOR THE CRAFTSMAN

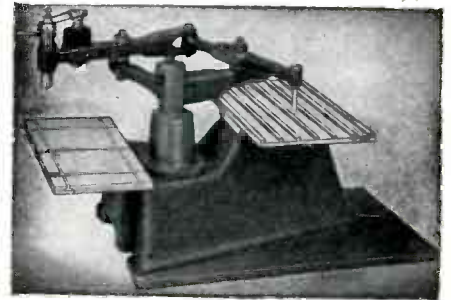

## DUPLICATING and PROFILING AUTO ENGRAVER

*Accurate Engraving  
with Unskilled Operators*

Unskilled operators will profile or accurately reproduce in smooth lines any design, number, letter, emblem, signature; on iron, brass, copper, aluminum, soft steels and all plastics. Here are some of its other uses . . .

- Drills a series of holes, or profiles small parts.
- Cuts an even channel for wiring on panels. Increases accuracy and production.
- Works from original drawing or templates.
- Etches glass and similar items.
- Will not cause distortion.

For complete information on this and other models and prices write Dept. K.

**AUTO ENGRAVER CO.**  
1776 BROADWAY, NEW YORK 19

**Control Devices.** Illustrated and described in a 10-page catalog are control devices for electronic, electrical and mechanical applications. Eastern Air Devices, Inc., 585 Dean St., Brooklyn, N. Y.

**Electric Plants.** A recent issue of Power Points is devoted to worldwide news of engine-generator sets manufactured by D. W. Onan & Sons, Minneapolis 5, Minn. One of the articles contained in the house organ is entitled "Rio Grande Runs Successful Tests on Train-Radio Communications."

**Solder, Tubing.** "Silver Solders and Gold Solders" is the title of a bulletin which tells about precious metal solders developed by D. E. Makepeace Co., 30 Church St., New York, N. Y. Another 4-page bulletin from Makepeace tells about sheet and wire tubing and assemblies of laminated or solid precious metals.

**Complex Wave Forms.** "Magnification of Details in a Complex Wave Form" is the title of an article by Rudolf Feldt, Tube Engineering Section, contained in Oscillographer, a publication of DuMont Laboratories, 2 Main Ave., Passaic, N. J.

**Resistor Selection.** A 28-page Engineering bulletin, No. R, by Shallcross Mfg. Co., Collingdale, Pa., is intended as a complete guide to accurate fixed wire-wound resistor selection and use of Shallcross types designed to meet JAN-R-93 specifications.

**Vibration Fatigue Testing.** Bulletin No. 425 describes Models 25-HA and 25-H vibration fatigue testing machines manufactured by All American Tool & Mfg. Co., 1014 Fullerton Ave., Chicago, Ill. Also available is Bulletin F which shows the complete All American line of automatic and manually controlled testing machines.

**Resistors.** A new resistor catalog of 32 pages describes and illustrates various types of units, gives sizes, resistance values, mounting and enclosures. Ward Leonard Electric Co., Mount Vernon, N. Y.

# New Amphenol Socket Puts Acorn Tubes into Wide Practical Use

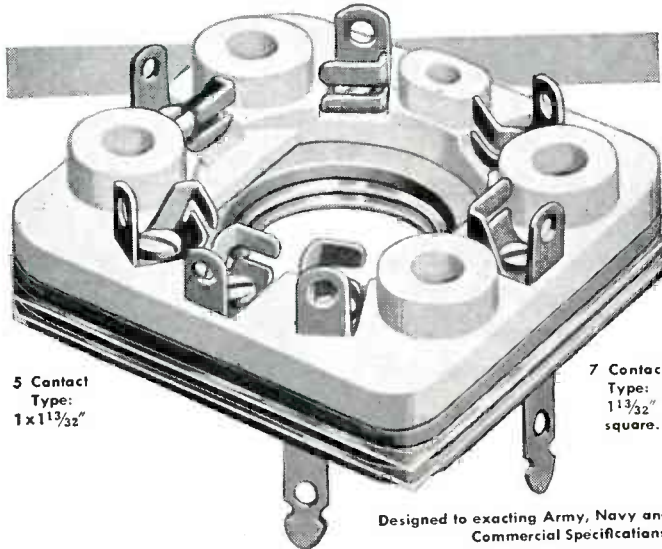

5 Contact  
Type:  
1 x 1 1/2"

7 Contact  
Type:  
1 1/2" square.

Designed to exacting Army, Navy and Commercial Specifications.

- New unglazed ceramic, all-over silicone treated to eliminate dielectric loss from moisture.
- New exclusively designed contacts for insertion and withdrawal without tube damage.
- New rotary connection insures centering (regardless of misaligned pins).
- Removal and replacement makes contact in same groove, eliminating change in external capacitance.
- Built-in bypass condensers for cathode and screen, keep lead inductance low.

The development of the acorn tube is now matched by Amphenol's development of a socket which will permit widespread applications. The design employs a gentle rotary action in making the connections without threat to the glass tube flange and pin leads. Get all data for future planning by writing at once.

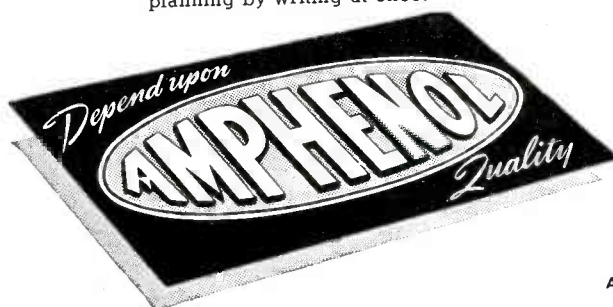

**AMERICAN  
PHENOLIC  
CORPORATION**

CHICAGO 50, ILLINOIS  
In Canada  
Amphenol Limited — Toronto

# PLASTICON\* CAPACITORS

Can you use a 10,000 VOLT PLASTICON  
1/8 the size of a corresponding paper capacitor?

Because of the 4400 volt per mil breakdown voltage of the Plasticon film dielectric, high voltage Plasticons are smaller, lighter and more economical than paper capacitors.

\*Plasticons—plastic film dielectric capacitors

**Condenser  
Products  
Company**

1375 NORTH BRANCH STREET  
CHICAGO 22, ILLINOIS

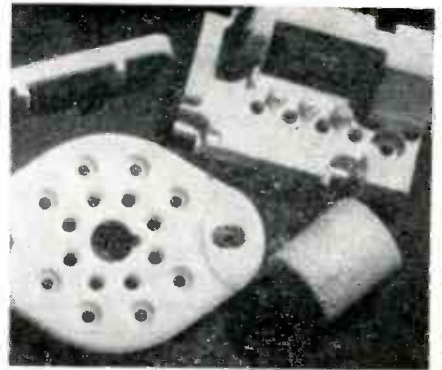

## Lavite STEATITE CERAMIC

Properties and Characteristics of Our  
LAVITE SI-5 Steatite Ceramic Body

Compressive Strength	96,000 lbs. per square inch	
Tensile Strength	7,200 lbs. per square inch	
Flexural Strength	10,500 lbs. per square inch	
Modulus of Rupture	20,000 lbs. per square inch	
Dielectric Strength	235 volts per mil	
Dielectric Constant	6.42	Frequency of
Loss Factor	2.90	1 megacycle
Power Factor	4.46	
Bulk Specific Gravity		2.664%
Density (from above gravity)	0.096 lbs. per cubic inch	
Hardness (Mohr scale)		7.0
Softening Temperature		2,350°F.
Linear Coefficient of Expansion		8.13x10 <sup>-6</sup>
Moisture Absorption (ASTM D-116-42-A)		0.009%

Makers of electrical and radio apparatus destined for war service are finding in LAVITE the precise qualities called for in their specifications . . . high compressive and dielectric strength, low moisture absorption and resistance to rot, fumes, acids, and high heat. The exceedingly low loss-factor of LAVITE plus its excellent workability makes it ideal for all high frequency applications.

We will gladly supply samples for testing.

### D. M. STEWARD MFG. COMPANY

Main Office & Works: Chattanooga, Tenn.  
Neehham, Mass. Chicago Los Angeles

## PERMANENT MAGNETS

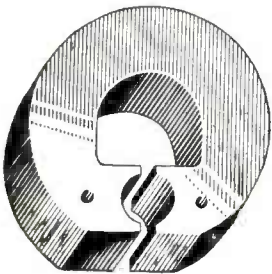

All Shapes—All Sizes—for All Purposes  
COBALT—CHROME—TUNGSTEN  
Stamped, formed and cast

**Alnico** (Cast or Sintered)  
under G. E. License

Also: Laminations for Radio Transformers  
TOOLS—DIES—STAMPINGS

Heat Treating of Metals and Alloys

**THOMAS & SKINNER STEEL PRODUCTS COMPANY**

1116 EAST 23RD STREET • INDIANAPOLIS 5, INDIANA



*For Radio  
at its Best*

Again, when the war is won, we will be on call

To DESIGN, DEVELOP  
and MANUFACTURE . . .

Radio Receivers and Transmitters  
Industrial Electronic Equipment  
Airport Radio Control Equipment  
Marine Radio Telephone Equipment

Your inquiries will receive immediate action

**ISLIP RADIO MFG. CORPORATION**

ISLIP, L. I., NEW YORK

*for Results*



**Mc GRAW-HILL**  
DIRECT MAIL LIST SERVICE

## If You Are Having Difficulty Maintaining Your Mailing Lists . . .

Probably no other organization is as well equipped as McGraw-Hill to solve the complicated problem of list maintenance during this period of unparalleled change in industrial personnel.

McGraw-Hill Mailing Lists cover most major industries. They are compiled from exclusive sources, and are based on hundreds of thousands of mail questionnaires and the reports of a nation-wide field staff. All names are guaranteed accurate within 2%.

When planning your direct mail advertising and sales promotion, consider this unique and economical service in relation to your product. Details on request.

**McGraw-Hill Publishing Co., Inc.**  
DIRECT MAIL DIVISION

330 West 42nd Street

New York, 18, New York



## NEW BOOKS

### Introduction to Practical Radio

By DURWARD J. TUCKER, *Chief Radio Engineer, WRR, KVP, KVPA, The Macmillan Co., New York, 322 pages, \$3.00.*

ELEMENTARY CIRCUIT components and circuit calculations are described for the beginner. The physical foundations for electricity and for magnetism are presented. Characteristics of the usually encountered radio resistors, inductors and capacitors are mentioned. The basic operations of arithmetic and algebra are introduced as needed. Ohm's and Kirchhoff's laws are applied to circuits composed of the elements being discussed and solutions for voltage and current are obtained by means of the accompanying mathematics. D-c and a-c power, equipment wiring, and instruments are also described.

Compared to Cooke's "Mathematics for Electricians and Radiomen," this new text has the advantage of including descriptions of electrical components and quantities, making it more self contained; also, it goes further into the use of trigonometric functions and vectors for solving a-c circuit problems, a *must* for today's radio technicians. However, this combination of practical circuit considerations and mathematical circuit solutions is poorly coordinated. For example, on page 116 a discussion of hysteresis heating of magnetics is dropped suddenly and, without any reason being given to the reader, logarithms are introduced. Nor is there much assistance given to the reader in understanding the significance of the assertions, as on page 55 where it is stated that the current-carrying capacity of conductors increases with size. There is no explanation about conductor rise in temperature, heat dissipation and insulation thermal conductivity that would indicate why there is a relationship between conductor size and current capacity.

Chapter VII on Kirchhoff's laws is a model on which the whole book could well have been patterned. In it the author, in giving illustrative algebra problems, has labeled terms and identified steps of the solution

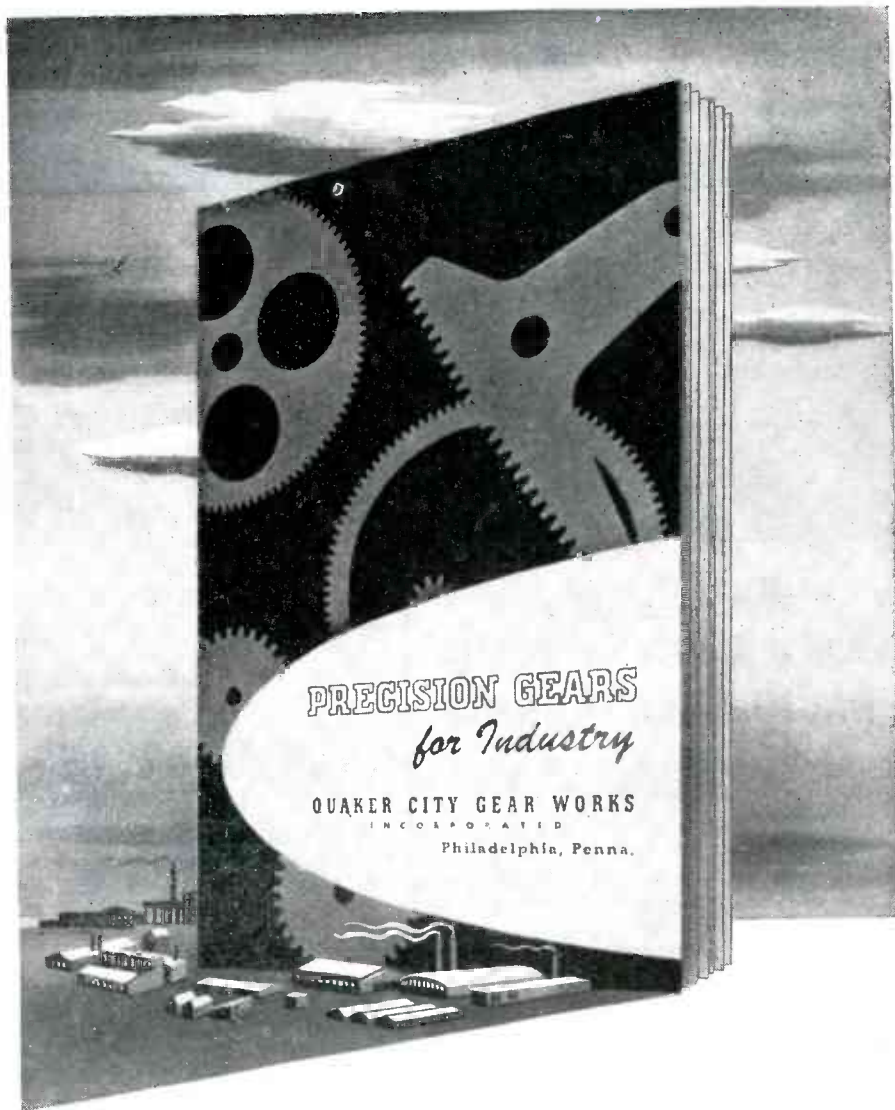

## Yours for the asking

A new informative booklet on gears.

It has illustrated sections  on practically every known form of gearing,

together with  many reference tables and formulas. Write for your copy

today on your company stationery. 

 **Quaker City Gear Works**  
INCORPORATED

1910 N. Front Street, Philadelphia 22, Pa.

# HERE'S HOW YOU CAN FIGURE

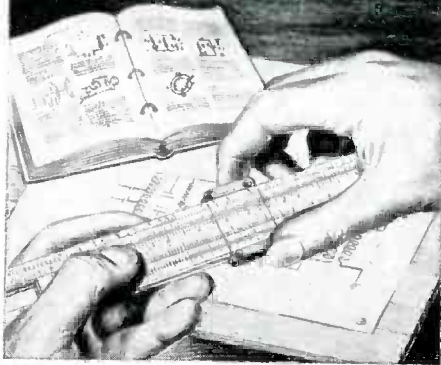

## —On a Better Job and a Secure Career in RADIO-ELECTRONICS

Add technical training to your practical experience . . . then get that *better* job you want!

CREI home study training in Practical Radio-Electronics Engineering equips you with the ability to go after—and get—a better, secure, engineering job.

After the war, will come the period of the "survival of the fittest." Employers can then once again afford to be "choosey" in selecting the best-trained men for the best jobs.

In our proved courses of training, you learn not only *how* . . . but *why*! Your ability to solve tough problems on paper, and then follow up with the necessary mechanical operation is a true indication that you have the *confidence* born of *knowledge* . . . confidence in your ability to get and *hold* an important job with a secure, promising future. . . . These jobs are waiting today for radiomen with up-to-date technical training.

Investigate CREI home study training now . . . and prepare for security and happiness in the coming New World of Electronics!

### • WRITE FOR NEW, FREE 36-PAGE BOOKLET

If you have had professional or amateur radio experience and want to make more money—let us prove to you we have something you need to qualify for a better radio job. To help us answer intelligently your inquiry — **PLEASE STATE BRIEFLY YOUR BACKGROUND OF EXPERIENCE, EDUCATION AND PRESENT POSITION.**



## CAPITOL RADIO ENGINEERING INSTITUTE

Home Study Courses in Practical Radio-Electronics Engineering for Professional Self-Improvement  
Dept. E-8, 3224 — 16th Street, N. W.  
WASHINGTON 10, D. C.

Contractors to U.S. Navy—U.S. Coast Guard—Canadian Broadcasting Corp. Producers of Well-trained Technical Radiomen for Industry

## TRANSFORMERS for ELECTRONIC APPLICATIONS

We are completely equipped for volume production. Write us concerning your requirements.



DONGAN ELECTRIC MFG. CO.

2977 Franklin

Detroit 7, Mich.

# DONGAN TRANSFORMERS

The Dongan Line Since Nineteen-Nine

We Invite Inquiries

### • INSTRUMENT HOUSINGS

### • PANELS

### • CHASSIS

### • METAL AND PLASTIC SPECIALTIES

### SCREW MACHINE PARTS AND STAMPINGS

*Manufactured to your Requirements*

Experienced fabrication and dependable service for all types of radio and electronic parts. Send us your drawings and specifications for quotation.

STAMFORD METAL SPECIALTY CO., 428 BROADWAY, N. Y. 13

*Metal Work of Every Description*

## GASES

## HYDROGEN NITROGEN-OXYGEN

ARGON-NEON  
HELIUM-KRYPTON  
XENON

COMPLETE GAS PRODUCTION PLANTS INSTALLED FOR LOWEST COST OPERATION . . .

FORMING MIXTURES  
CARBON DIOXIDE  
ACETYLENE

HIGHEST QUALITIES • ANY QUANTITY DELIVERED ANYWHERE

## AMERICAN GAS & CHEMICAL CO.

HARRISON, NEW JERSEY • Contracted Complete Service on All Gases



C & D

with their mathematical name so that the reader can readily follow what is being done, and has associated the text description with the analytical work.

In general, however, the mathematical discussions suffer from looseness. Arithmetic, it is explained on page 15, deals with digits, and with the operations of addition, subtraction, multiplication, and division, and does not deal with negative numbers (this latter in italics). To the technician the inconsistency of dealing only with digits and yet using division (from which fractions will rise) and of not dealing with negative numbers yet using subtraction (which in itself deals with negative numbers and frequently produces negative numbers) will not be apparent until he continues his studies in more precisely written texts.

The overall presentation is that of arbitrary statement. There is little or no causal explanation of the whys and wherefores of electrical behavior, component characteristics and mathematical processes. As an illustration of this didactic style, the entire section purporting to describe capacitance consists of the statement that "The capacitance of a condenser depends on a number of factors. The capacitance of a simple two-plate condenser whose plates are relatively large and closely spaced is given by the equation:

$$C = \frac{.0885 KA}{10^6 \times t}$$

where

$C$  = capacitance in microfarads

$K$  = dielectric constant of dielectric

$A$  = area of the dielectric in square centimeters

$t$  = thickness of the dielectric in centimeter (1 inch = 2.54 centimeters)"

Such arbitrary information is useless. The educational value of a book written along such lines is nil. Handbooks, intended for reference, are the only books that need not explain clearly why the facts presented are so.

This book is suggested for home study. If the reader learns only by rote he will obtain a rudimentary knowledge of components and arith-

# CML 1420

## ELECTRONIC GENERATOR

Frequency stability of the CML 1420 is better than 2% after initial warm-up.

Maximum distortion at full output into resistive load is 10%. Regulation no-load to full load within 4%. Nominal regulated voltage output 80-120-135-215-255 or 270 volts. Power input 115 volts 60 cycles 1200 watts single phase.

# TEST POWER for Continuous Duty

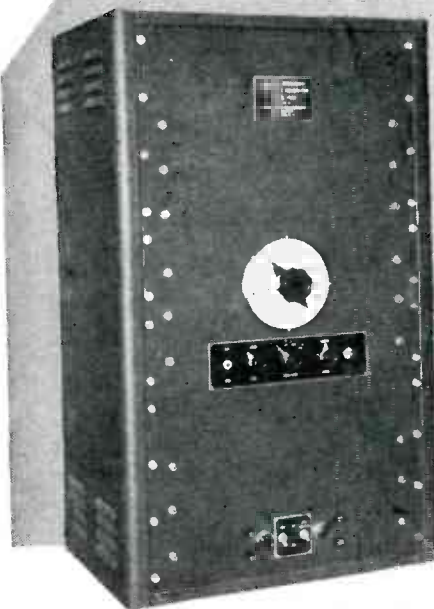

FREQUENCY RANGE:

50 to 6,000 Cycles in 4 bands

POWER OUTPUT:

250 Watts Continuous Duty

FREQUENCY CONTROL

Single dial, direct reading, linear scale in 4 ranges—50-180; 170-600; 500-1800; 1700-6000 cycles.

Send For Descriptive Bulletin

# COMMUNICATION MEASUREMENTS LABORATORY

120 Greenwich St., New York 6, N. Y.

Rotobridge • Electronic Generators • Power Supply Units

# DESIGN COUNTS



## COMPARE

a modern sewing machine with the old-time model shown here. The difference is an example of how careful attention to design brings about a high level of efficiency.

Realizing this, design is one of the most carefully considered factors in the production of antennas at THE WARD PRODUCTS CORPORATION. It is only through superior design that the benefits of experience and the finest production facilities can be best brought to the user.

For the finest antennas for all applications... for home and automobile use... look to WARD.

# WARD

Antennas  
 BUY WAR BONDS  
 THE WARD PRODUCTS CORPORATION  
 1523 EAST 45TH STREET • CLEVELAND 3, OHIO

Export Dept. C. O. BRANDES, Mgr.  
 4900 Euclid Avenue  
 Cleveland 3, Ohio  
 Canadian Office: ATLAS RADIO CORP.  
 560 King Street, W.  
 Toronto 1, Ont., Can.

metic from this book, but if he hopes to learn through *understanding* he had best look elsewhere for an introductory work. This criticism is not directed solely at this book. Altogether too many books are being published today on technical subjects that do not explain; they merely describe. A 300-page list of arbitrarily stated facts, useful as they may be if understood, does not constitute an introduction to radio.

What is needed in this and other growing technical fields is not technicians who do thus and so because they are told to, but young men who can be given the responsibility to do the job because they understand the fundamentals. It is the function of an introductory book to explain those fundamentals; there is plenty of space in service manuals for dictatorial instructions.

Nor need it be feared that technicians cannot learn by explanatory treatment. Rather—and this has been the experience of this reviewer in teaching technicians at night school—they do not want the *what* without the *why*; they retain the information longer if they have a sound understanding of why it is so. They can—and would rather—learn the right reason instead of some simplified but false or incomplete explanation.

The book is well edited and adequately illustrated. The clear typography and pleasing type face make it readily readable. Boldface paragraph headings, and italic key words and important statements assist greatly in orienting the reader and emphasizing the material.—F.R.



A **WEB-LIKE PATTERN** of 650 loudspeakers carries news broadcasts from WADC to workers in the plant of Goodyear Aircraft Corp. at Akron, O.



**WHEN THE WAR ENDS**, an estimated three billion dollars worth of radio equipment and two billion dollars of radar apparatus will be declared surplus by the Army.



**DIAMOND DIES** for drawing wire have been made by drilling the minute hole with an electric spark from a platinum needle while both are immersed in a chemical solution.



## Sherman Offers QUICK DELIVERY On Hundreds Of Styles of ELECTRICAL TERMINALS

One of the largest, most complete lines of Electrical Terminals available anywhere, is offered you by Sherman. Hundreds of styles are available, and others are constantly being added. Most of these are kept in stock, ready for quick shipment.

Sherman probably has a stock terminal exactly suited to your own particular requirements. If not, we would be happy to have you submit your specifications to our engineering departments.

Sherman also makes many other high quality electrical fittings, such as soldering and solderless lugs, fuse clips, etc. Write today for Sherman catalog.

**H. B. SHERMAN**  
 Mfg. Company  
 Battle Creek  
 Michigan



# Sherman



**LUGS,  
TERMINALS, FUSE CLIPS**

## AIRCO GAS PROPORTIONER

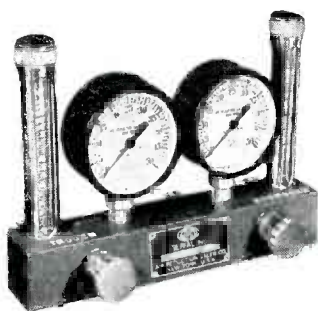

### CONVENIENT — ACCURATE GAS MIXING DEVICE

Designed to meet the needs of electronic tube manufacturers using gas mixtures for protective atmospheres, this new Airco development produces an accurately proportioned mixture at a pressure not in excess of 5 psi. A complete line of flowmeters is available to permit flows of hydrogen from about 2 to 200 cfh. and of nitrogen from about 6 to 140 cfh.

For full details, write today for a descriptive folder (ADI-892). Address:

## AIR REDUCTION

60 East 42nd Street  
New York 17, N. Y.



OFFICES IN  
PRINCIPAL CITIES

In Texas: Magnolia Airco Gas Products Company

## ENGINEERS WANTED

Here's an opportunity to join one of America's largest manufacturers of electronic and communications equipment.

**Radio**  
• **Electrical**  
• **Electronic**  
• **Industrial**  
(Job evaluation)  
• **Mechanical**  
• **Factory Planning**  
• **Materials Handling**  
• **Manufacturing Planning**

Work in connection with the manufacture of a wide variety of new and advanced types of communications equipment and special electronic products.

Write giving full qualifications,  
or apply to:

R. L. D., EMPLOYMENT DEPT.

### Western Electric Co.

100 CENTRAL AV. KEARNY, N. J.

• Also: C. A. L.

Locust St. Haverhill, Mass.

Applicants must comply with WMC regulations

# HEXACON *is helping to do* *the job at* CONSOLIDATED VULTEE AIRCRAFT CORPORATION

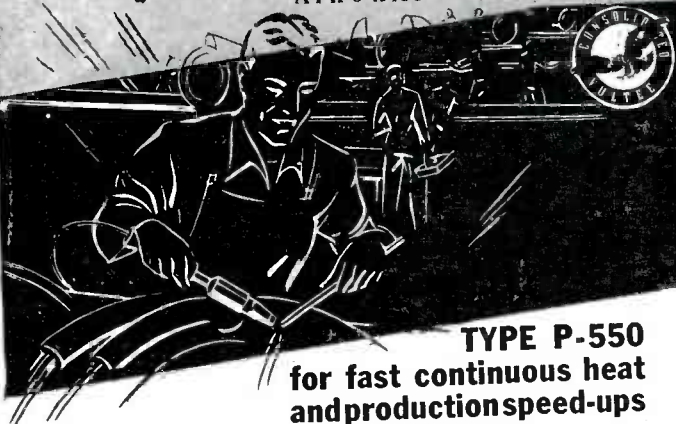

### TYPE P-550 for fast continuous heat and production speed-ups

Heavy-duty work requires a soldering iron with heat reserve sufficient for continuous use. The ability of HEXACON irons to cope with these essentials is attested to in their adoption by Consolidated-Vultee in vital plane production. Design and construction is an important factor in HEXACON performance.

Write for literature describing the complete HEXACON line of screw tip and plug tip irons, from 40 to 700 watts, and with tip diameters ranging from 1/4" to 1 3/4". No obligation.

**HEXACON ELECTRIC COMPANY**  
130 WEST CLAY AVE., ROSELLE PARK, NEW JERSEY



## HEXACON



CUP WASHERS  
for Binding Screws



**WHITEHEAD STAMPING CO.**  
1691 W. Lafayette Blvd. Detroit 16, Michigan

*Preferred*

as a source of precision-made  
**WASHERS and STAMPINGS**  
manufactured to  
your specifications.



## INDICATOR LAMPS

Indicate and identify circuit operations on radio transmitters and electronic devices. Lock-on caps, available in five different colors, cannot shake loose. Caps and bases of sturdily constructed molded plastic. Easy to mount. With or without "dim-out" feature. For further details write

Electronics Department, General Electric, Schenectady 5, N.Y.

**GENERAL ELECTRIC**

177-DL-1

# HARVEY

is taking orders for the newly improved

## REK-O-KUT

### RKD-16

DUAL SPEED 16-INCH RECORDING MOTOR ASSEMBLY



To essential users\*, HARVEY can now supply the famous RKD-16, with new features that materially increase the life and performance of the unit. Its rugged construction and precise assembly have made this REK-O-KUT instrument generally preferred by major broadcasting stations and recording studios. A heavier turntable, closer machining tolerances and an improved lubrication system now add to its efficiency.

Three week delivery.....\$148.38

### Features of the REK-O-KUT RKD-16

- Latho turned, 25 lb. cast iron turntable, balanced, with disappearing drive pin and rubber turntable pad.
- Turntable fitted with one inch diameter polished steel shaft, with special oil grooves for force feed lubrication when operating. Rotates on a single ball bearing at the bottom of the turntable well.
- 1/20 H. P. General Electric constant speed motor.
- A positive repeat speed change at all times.
- The turntable attains full speed in less than one revolution.
- Easy alignment of the REK-O-KUT overhead mechanism with the turntable.
- Improved lubrication system.

\*AA-5 Priority or Better!

NOTE: Since our monthly allotment is subject to WPB regulations, we suggest that you send your order without delay.

Telephone: LOnacre 3-1800

# HARVEY

103 WEST 43rd ST., NEW YORK 18, N. Y.

## Backtalk

This department is operated as an open forum where our readers may discuss problems of the electronics industry or comment upon articles which **ELECTRONICS** has published

### On Mitogenetic Radiation

Dear Sir:

I HAVE JUST come across O. C. Gruner's (**ELECTRONICS**, Dec. 1944,) paper on A Neon-counter for Medical Research and feel obliged to address one or two remarks to you on the subject.

The author states that "Hollaender and other physicists decided that mitogenetic radiation does not exist at all." This is not so. Hollaender examined the problem fairly and came to the conclusion that the evidence for the existence of mitogenetic radiation is not sufficiently convincing at present to be generally acceptable. This is a conclusion which, as far as I know, has not been challenged by any responsible authority. A recent survey made by Moiseeva, has led to the same conclusion.

The author states that "the Geiger counter failed to reveal conclusive evidence of these radiations, but it was thought that a neon counter might serve the purpose." Since a Geiger counter, properly used, will permit the detection of a single ionized particle, it has a very much greater sensitivity than any other device in the ultra-violet region, where most of the mitogenetic radiation is supposed to occur.

The author states that "If the material to be studied emits a radiation which adds to the potential (of the neon lamp), the beats of discharge will become more frequent; if the material interferes with the accumulation of potential, the beats will slow down." This statement reveals a curious ignorance as to the operation of the neon-tube relaxation oscillator. If ionizing radiation passes through the space between the electrodes of the tube, the ions produced may cause the capacitor to discharge more quickly, but no amount of radiation could possibly increase the potential of either electrode. It is, however, well known that



## BE WITH YOU IN A MINUTE—

The Insuline Corporation is still 80% in war production. In fact, it has received its third Army-Navy Award, and is out to earn a fourth. Still the ICA Plant is geared to swing into full peace-time production almost instantly

The radio industry, planning for the post-war market, will want to investigate the now-famous line of battle-tested ICA Auto Antennas. Careful engineering makes them rattle-proof; all-brass construction makes them rust proof.

A catalog, detailing everything that's news in antennas designed for the post-war market, is available. Ask for Catalog No. AA-216.

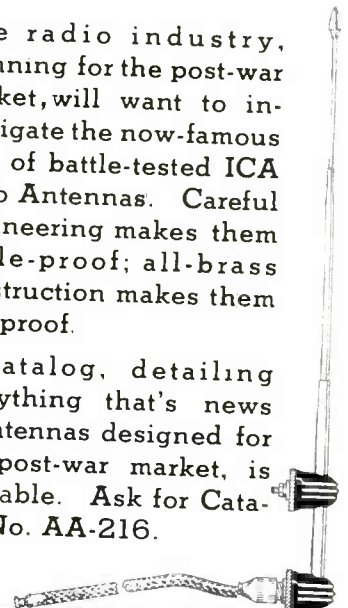

# INSULINE

CORPORATION OF AMERICA

Quality Products Since 1921

INSULINE BUILDING  
LONG ISLAND CITY, N. Y.

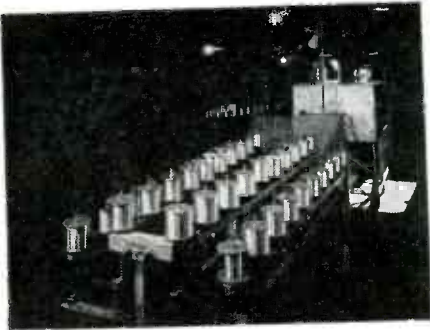

## RESISTANCE WIRE

### ALLOYS FOR EVERY PURPOSE

**ALLOY "A"** — Nickel - chromium; non-magnetic; spec. resistance 650 ohms/CMF.

**ALLOY "C"** — High resistance to oxidation and corrosion; for electronics and industrial equipment.

**ALLOY "D"** — Nominally 30% nickel, 15% chromium, balance iron. Specific resistance 600 ohms/CMF.

**ALLOY "45"** — Copper-nickel for winding precision resistors. Constant resistance over wide range of temperatures.

**KANTHAI** — Unavailable for duration; we will be pleased to supply data for your post-war requirements.

The **C. O. JELLIFF MFG. CORP.**  
123 Pequot Rd. Southport, Conn.

## TEST YOUR MAGNETIC CIRCUITS



RAWSON FLUXMETER TYPE 504

The only portable fluxmeter available which returns rapidly to zero when a single button is depressed. Simple and fast in operation. Convenient and light in weight.

Not limited to a single type of measurement. Has universal application for laboratories or production. Measures strength of magnets and electromagnets, permeability and hysteresis loops for iron and steel, total flux lines in circuit, flux lines developed in air gap, etc.

Has a mechanical clamp to protect the pivots and jewels when in transit.

Low price \$125 net FOB Cambridge, Mass.

### RAWSON ELECTRICAL INSTRUMENT COMPANY

110 Potter Street, Cambridge 42, Mass.  
Representatives  
CHICAGO NEW YORK CITY

#### EXACT Q VALUES:

Precision manufacture assures exact Q values. Resulting uniform tuning and gain helps speed equipment production.

#### UNIFORM COMPOSITION:

Core compositions — accurately controlled — permit uniform control of core loss, to exact predetermined level.

#### MECHANICAL STRENGTH:

Modern metallurgical and plastic molding techniques assure permanent retention of characteristics.

#### SIZES AND SHAPES:

Screw cores, cup cores, tuning slugs are produced in any desired type, with uniform quality and accuracy.

#### THREADED RODS AND INSERTS:

These are incorporated when required. Precision machining permits fast assembly and accurate tuning.

#### FREQUENCIES:

Iron cores manufactured exactly to meet your specifications in both high and low frequencies.

★ ★ ★

National MOLDITE can be produced to fit any coil requirements for either present or post-war needs. Inquiries will be treated in confidence, and given prompt attention.



**NATIONAL MOLDITE COMPANY**  
25 MONTGOMERY STREET, HILLSIDE 5, NEW JERSEY

# NATIONAL MOLDITE IRON CORES



## NORCO

### COAXIAL TRANSMISSION LINES AND FITTINGS

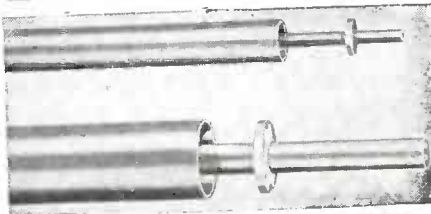

NORCO coaxial cables, of the rigid gas filled type, for radio communication, radar, television, and FM. A complete line of fittings, both solder, and improved solderless types can be supplied for NORCO Transmission Lines, including improved End Seals and Junction Boxes, Your inquiry invited.

**NORTHERN COMMUNICATIONS MANUFACTURING CO.**  
210 EAST 40th STREET NEW YORK 16, N. Y.  
Manufacturers of Transformers • Special Coils • Reactors • Sound Systems  
Recorders • Equalizers • Full Range Phonograph • Coaxial Transmission Lines

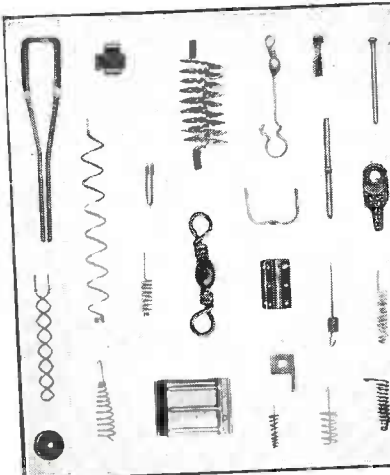

## SMALL PARTS

Filaments, anodes, supports, springs, etc. for electronic tubes. Small wire and flat metal formed parts to your prints for your assemblies. LUXON fishing tackle accessories, double pointed pins, fine sizes wire straightened. Inquiries will receive prompt attention.

### ART WIRE AND STAMPING CO.

227 High St. Newark 2, N. J.



## WALDEN WORCESTER WRENCH SETS

Engineered for Strength and to fit the mechanics need. Thousands of these sets have been sold here and abroad.

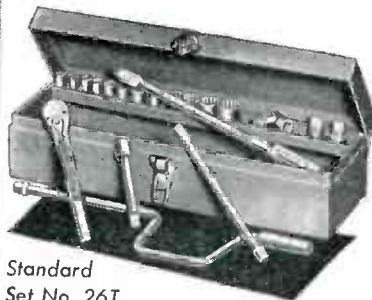

Standard  
Set No. 26T

The Mechanics Favorite. Wide range of Sockets, Special Handles, Reversible Ratchet Wrench. 22 pieces in a Steel Box.

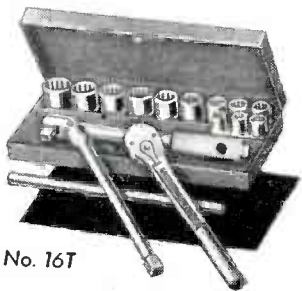

Set No. 16T

A very handy set of 17 pieces in a Steel Box.

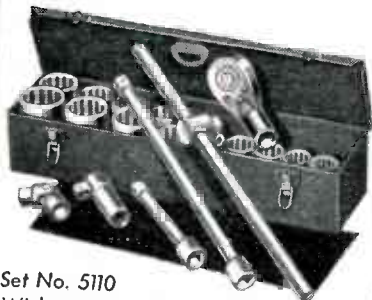

Set No. 5110

Wide range of Sockets, Special Handle, Reversible Ratchet Wrench. 21 pieces in a Steel Box.

Send for Catalog No. 141 picturing a full line of Automobile, Aircraft and Radio Tools.

**WALDEN  
WORCESTER  
WRENCHES**

**STEVENS WALDEN, INC.**  
468 SHREWSBURY STREET  
WORCESTER, MASSACHUSETTS

random variations in the frequency of this type of oscillator are caused by small variations in the illumination of the lamp, in the surrounding temperature, and in the supply voltage. Since Mr. Gruner quotes no numerical results in support of the observations he claims to have made, it is difficult to avoid the suspicion that what he has found is no more than fluctuation of this kind.

J. M. A. LENIHAN

Newcastle upon Tyne 2  
England

(1) Moiseeva, Comptes Rendus Acad. Sci., USSR, 30, p. 356, 1941.

Dear Mr. Henney:  
THANK YOU very much for showing me Mr. Lenihan's letter commenting on the subject of the neon-counter.

As regards Item 1, in which Mr. Lenihan says my remark about Hollaender is at fault, his answer is that Hollaender considered "the evidence for the existence of mitogenetics rays not sufficiently convincing"—surely is only using different, if more exact, words to say the same thing. However, the physicists here were more sceptical about these rays.

As regards Item 2, the wording might also be improved by "such radiations" instead of "these radiations," because the impression derived from researches here indicated that a radiation of some kind might be emitted both from cancerous blood and tissue which is not mitogenetic (because the blood should not react like tissue) yet equally difficult to demonstrate. The idea of constructing a neon counter for the work was not discouraged by the physicists consulted here.

As to Item 3, Mr. Lenihan implies that the random fluctuations in frequency entirely rule out the propriety of using the oscillator for the work in question. Experience showed a consistent difference under controlled conditions between cancer blood and normal blood, if examined fresh. The data would only be suitable for a medical journal, and for that—as for all medical statistics—at least two series of 1000 tests each should be completed, unless definite failures were encountered sooner.

Acquaintance with the criticisms of Items 1 and 2 was already provided by Rahn's monograph (Pro-

## PROFESSIONAL SERVICES

Research      Production  
Design        Management  
Development   Sales  
Publications

## ASSOCIATED ELECTRONICS CORPORATION

CONSULTING ENGINEERS  
Complete Engineering Service for all Industries  
RESEARCH      MANAGEMENT  
DEVELOPMENT      PRODUCTION  
DESIGN              PUBLICATIONS  
132 Nassau Street,      New York, 7, N. Y.  
251 Kearney Street,      San Francisco, 8, Cal.

## MICHAEL BOZOIAN

Consulting Service in Electronics  
Instrumentation & Controls Design—Development—Models Literature & Patent Surveys  
Recommendations for New Laboratories.  
Telephone 8521  
702 Fifth Street      Ann Arbor, Mich.

## STANLEY D. EILENBERGER

Consulting Engineer  
INDUSTRIAL ELECTRONICS  
Design—Development—Models  
Complete Laboratory and Shop Facilities  
6309-13—27th Ave.  
Kenosha, Wis.      Telephone 2-4213

## ELECTRONIC ENGINEERS

Designers and Consultants  
Design for Manufacture—Radio and Electronic products designed to your specifications.  
Engineering models      Production drawings  
Consulting—Radio and Electronic Problems  
Complete Development and Research Laboratories  
Branch Office Near Chicago  
611 E. Garfield Ave.      Glendale, California

## DON FOSTER

Engineering Consultant

Electrical      Specialist in      Mechanical  
Analysis      Sound and Electronics      Development

30 Burns Ave., Wyoming 15, Ohio

## PAUL E. GERST & CO.

CONSULTING ENGINEERS

Specialists in

Electrical Product Design  
El. Machinery, Apparatus & Applications  
El. Appliances, Hi-Frequency Apparatus  
Electronics, Radio Communication.

205 W. Wacker Dr.

Chicago 6, Ill.

## HODGSON & ASSOCIATES

Physics, Mathematics, Research, Development & Patent Consultants.

Satisfaction guaranteed. Submit your problem for a preliminary survey without cost.

Box 874

Sherman Oaks, California

## JOSEPH RAZEK, Ph.D.

Consulting Physicist

Electrical and Mechanical Engineering Problems  
Instruments and Control Devices      Electronics  
Specialists in Colorimetry, Spectrophotometry and  
Industrial Color Control  
Laboratory and Shop Facilities

202 Darby Road

Phone Hilltop 6910

Lianerch, Pa.



# CONTACTS

FOR THE FIELD OF ELECTRONICS

**SOMETHING NEW!**  
Sleeveless type

## TUNGSTEN LEADS

PRODUCED FROM CONTINUOUS SPOOLS OF WIRE EITHER STRANDED OR SOLID ASSURING OVERALL UNIFORMITY. EACH TINY WIRE OF THE STRANDED CABLE IS POSITIVELY FUSED TO THE TUNGSTEN

Write for details & Samples

GLENDALE VACUUM PRODUCTS CO.  
8816-77th Ave. Brooklyn 27, N. Y.



FINE RIBBONS OF  
**TUNGSTEN and MOLYBDENUM**

Quality and accuracy in our fabrication of Tungsten & Molybdenum Ribbons have characterized our service to the Electronic Industry.

A development of  
**H. CROSS CO.**  
Beekman St., New York 7, N. Y.

## Electron Tube Machinery

of every type,—standard, and special design

Specialists in Equipment for the manufacture of Radio Tubes, Cathode Ray Tubes, Fluorescent Lamps, Incandescent Lamps, Neon Tubes, Photo Cells, X-ray Tubes and other glass or electronic products, on production or laboratory basis.

**Kable**  
**ENGINEERING COMPANY**

1307-1309 Seventh St., North Bergen, N. J.

We manufacture a complete line of equipment



SPOT WELDERS, electric from ¼ to 50 KVA  
TRANSFORMERS, special and standard types  
INCANDESCENT LAMP manufacturing equipment  
FLUORESCENT TUBE MAKING EQUIPMENT  
ELECTRONIC EQUIPMENT, vacuum pumps, etc.  
WET GLASS slicing and cutting machines for laboratory use  
GENERAL GLASS working machines and burners  
COLLEGE GLASS working units for students and laboratory

AC ARC WELDERS from 100 to 400 Amps



EISLER ENGINEERING CO.  
731 So. 13th St. (near Avon Ave.) Newark, New Jersey

**Precision Cut Electronic Specialties**  
Die Cut To Your Individual Specifications

SHIMS WASHERS  
GASKETS INSULATORS  
**CONDENSER LINERS**

Made from kraft paper, fishpaper, drawtex, hitex or any other types of electrical insulation papers.

FAST ACCURATE SERVICE  
PHONE—WRITE or WIRE  
**HOWARD J. MOORE COMPANY**  
108 Park Row N. Y. 7, N. Y.  
COrtlandt 7-6799

**YOUR NEW FREE CATALOG IS READY FOR YOU!**

Radionic's Catalog No. 26 lists hard-to-get radio parts! • Helps you fill your radio and electronic needs. • All parts are available for immediate shipment • All are highest quality. • All are exceptional values.

SEND TODAY FOR YOUR FREE COPY TO  
Dept. 8A

**RADIONIC EQUIPMENT CO.,**  
"CHANCELLOR" PRODUCTS  
170 NASSAU STREET, NEW YORK 7, N. Y.

**Strip Insulated Wires**  
QUICKER... BETTER

with "Speedex"  
AUTOMATIC WIRE STRIPPER  
...Speeds Production

Strips insulation from all types of wire—Instantly, easily, perfectly. Just press the handles and the job is done. Cuts wire too. Strips 800 to 1000 wires per hour. Available for all size solid or stranded wires—No. 8 to No. 30. List Price \$6.00. Write Dept. E for Full Particulars



**GENERAL CEMENT MFG. CO.**  
Rockford, Illinois, U.S.A.

**MICROMETER FREQUENCY METER**

for checking Transmitters from 1.5 to 56 mc., within 0.01 per cent

**LAMPKIN LABORATORIES**  
Bradenton, Fla., U. S. A.

**Burned Out or Broken Electric Heating Elements**



repaired with NICHRO-CITE PASTE. Simply overlap ends, apply paste, turn on current. Used by utility companies, etc. Family size, \$1.00, 4 oz. size \$2.50. Satisfaction guaranteed.

Armstrong Mfg. Co., Box 861G Minneapolis, Minn.

**BRAZILIAN QUARTZ CRYSTALS**

**CRYSTAL TRADING COMPANY**

Importers  
118 Liberty St. New York 6, N. Y.

If this or other advertising does not supply the information concerning products or services wanted, please write:

**ELECTRONICS,**  
New York City

**MORE RF KILOWATT HOURS PER DOLLAR WITH**

**F & O TRANSMITTING TUBES**

Inquiries Invited—Let us explain how Savings are effected and the F & O greater guarantee.

**FREELAND & OLSCHNER PRODUCTS Inc.**

611 Baronne St., New Orleans 13, La.  
Raymond 4756

High Power Tube Specialists Exclusively  
(5 KW To 100 KW)



**MINIATURE BALL BEARINGS**  
for precision instruments, electronic devices  
RADIAL SERIES (see left) 1/8" to 5/16" outside diameter  
PIVOT SERIES 2 to 10 mm. outside diameter  
For complete specifications, prices—write for catalog 431-82

**MINIATURE Precision BEARINGS**  
KEENE, NEW HAMPSHIRE, U. S. A.

**FREE TO RADIO MEN**

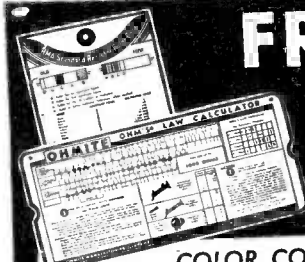

**COLOR CODE and OHMS LAW CALCULATOR**

Burstein-Applebee of Kansas City offers you this great convenience FREE. Easy to work. Solves many problems in a jiffy. FREE to radio men, electronic engineers and others in the business. Attach coupon to your letterhead.

MAIL COUPON NOW

**BURSTEIN-APPLEBEE CO.**  
1012 MCGEE, KANSAS CITY 6, MO.  
Send me FREE Color Code and Ohms Law Calculator along with latest catalog.

I am \_\_\_\_\_ STATE CONNECTION IN INDUSTRY

NAME \_\_\_\_\_

ADDRESS \_\_\_\_\_

TOWN \_\_\_\_\_

STATE \_\_\_\_\_

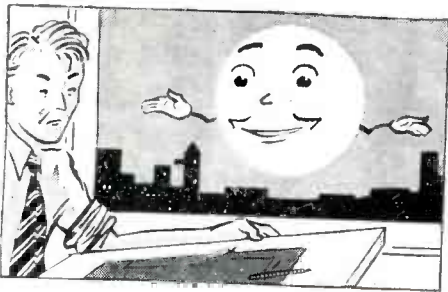

Wait, pal . . .  
don't get the  
blueprint blues!

I know your blueprints are so blurred you couldn't read 'em with a magnifying glass. Same old trouble — soft, crumbling leads, smudged drawings, bad blueprints.

Get yourself the drawing pencils that never crumble; that produce clean, dense, opaque lines; that are unerringly uniform in every degree. Get Typhonite Eldorado! Eldorado drawings result in blueprints as clear as a bell and a pleasure to read.

For anybody's money, Typhonite Eldorado is the world's finest drawing pencil. Try it! Send for a free Comparison Sample. Request it on your business or professional stationery, specifying degree.

**DIXON'S  
TYPHONITE**

**ELDORADO**

Pencil Sales Dept. 59-J8

JOSEPH DIXON CRUCIBLE CO., Jersey City 3, N. J.

toplasma Monographien, 1936, vol. ix), especially pages 91 and 92. As to the last paragraph of Mr. Lenihan's comments, one may mention the work done at the Roffo Institute at Buenos Aires (details of which were published since the experiments were made here). A very close study of the carcinogenetic radiation from sterols in cancer was made by undoubted experts, and besides other methods of investigation, a neon counter was devised for the purpose.

Maybe the object of the work is misunderstood. There was no idea that this counter refutes Hollaender's conclusions, or challenges them or any responsible authority. Its construction originated in the desire to arouse the interest of electronic experts in an important field of clinical investigation, aware that an actual instrument provides a preliminary demonstration, from which they might proceed to something of wider scope in this branch of medical research.

O. CAMERON GRUNER  
*McGill University  
Montreal, P.Q., Canada*

#### Audionics

My dear Henney:  
I HAVE BEEN very remiss in not having long ago expressed to you my natural and very deep gratification over the cover of *ELECTRONICS* in April.

There indeed is a notable example of the truth of the old Chinese adage: "A Picture Is Worth 10,000 Words."

Your photographer selected for this picture a beautiful sample of one of the early Audions, I think of the 1909 vintage. Earlier types included only a single plate and grid.

With best wishes to *ELECTRONICS*, and regards to its editor.

LEE DE FOREST  
*Experimental Laboratory and Inventory  
Los Angeles, Calif.*

#### About Turnovers

Dear Sirs:  
CONGRATULATIONS on the new arrangement of editorial matter in June 1945 issue. Having all of the article appear consecutively makes reading much easier, and is a tremendous help when it comes to binding *ELECTRONICS*.

RICHARD P. KREBS  
*Cleveland, Ohio*

# FREE! NEW 11th EDITION RADIO'S MASTER

The only official  
Radio and Electronic  
equipment source-book

Tells you:

#### WHAT

the product does, its specifications, comparable and competing items . . . Thousands of illustrations . . . Data covers 90% of all products in the industry, each item indexed and cross indexed.

#### WHO

makes it. Directory of manufacturers alphabetically listed, with page numbers for instant reference.

#### HOW MUCH

Prices on thousands of items, all clearly catalogued for easy buying.

#### WHERE

you can get it. Your nearest sources that can supply your radio and electronic requirements. Saves time . . . Eliminates bulky files.

**IMPORTANT**

Distributors  
from coast to  
coast have just  
bought quantities  
of this 800  
Page, hard-covered  
encyclopedia ready for free  
distribution.

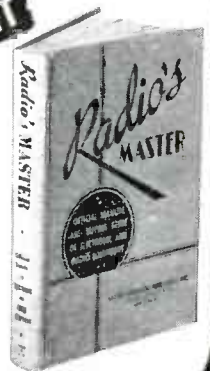

If you are an Engineer or Purchasing Agent WRITE FOR FREE COPY NOW.

★ Write us on your company letterhead and we'll put you in touch with the jobber nearest you who has your FREE Copy. No obligations.

Address Dept. FEP

**UNITED CATALOG**  
PUBLISHERS, INC.  
110 Lafayette St., New York 13, N. Y.



## POSITIONS VACANT

**MALE HELP** wanted. Manufacturer of dental, electrical and mechanical equipment needs services of a design engineer of experience with reasonable knowledge of electrical and mechanical appliances. Good position. Permanent for right person. Factory located in Ohio. Give full particulars in your application. P-885, Electronics, 520 N. Michigan Ave., Chicago 11, Ill.

**POSITIONS AVAILABLE**—Design, Development, and Research Engineers. Mechanical of electrical for work for one of the largest Resistance Welder Manufacturers. Salary open. Located eastern Ohio. Our employees notified of this ad. Reply giving qualifications. P-886, Electronics, 520 N. Michigan Ave., Chicago 11, Ill.

**MAN OF** formanship caliber. Capable of setting up and running Waterbury Farrell Tubular, Hi-pro, and standard two-stroke Headers, producing rivet blanks of steel, copper and nickel to close tolerances. Must also be able to make or design own header dies. Currently running 54 hours per week. The man selected will be placed in charge of header department of our Tungsten Division. Established industry with no reconversion problem. All applications will be treated confidentially and should be as detailed as possible. Phone, write or wire to H. A. Wilson Co., Personnel Dept., 105 Chestnut St., Newark 5, N. J. Telephone Ma-2-5561.

(Additional Positions Vacant ads on pages 416, 425, 432, 433, 434, & 435)

## EMPLOYMENT SERVICE

**SALARIED POSITIONS**—This advertising service of 35 years recognized standing negotiates for high salaried supervisory technical and executive positions. Procedure will be individualized to your personal requirements and will not conflict with Manpower Commission's. Retaining fee protected by refund provision. Identity covered and present position protected. Send for details. R. W. Bixby, Inc., 278 Delward Bldg., Buffalo 2, N. Y.

## POSITION WANTED

**INDUSTRIAL PHYSICIST:** With 10 years experience in electronic research and development and 4 years manager of cathode ray tube manufacturing plant desires situation in enterprising organization. PW-867, Electronics, 330 W. 42nd St., New York 18, N. Y.

## SALESMAN AVAILABLE

**SALES ENGINEER**—Available for postwar position for Boston or N. E. area. Young, aggressive. Electronics Production Engineer with thorough knowledge of machine shop practice. Prewar motor sales and office management experience. Graduate B.E. SA-834, Electronics, 330 W. 42nd St., New York 18, N. Y.

Technical writer of wide experience, now in electronics, wishes position with progressive manufacturer, preferably in Middle West. Release promised when desired.

## H. H. KETCHAM

Box 221 Piqua, Ohio

## Curt E. Patton Personnel Engineers

53 W. Jackson Blvd. Chicago 4

offer industry a confidential Personnel Service, selecting and presenting men for positions open—on either a fee or retainer basis.

Outstanding men in electronic and allied fields, with legitimate reasons for seeking a change, are invited to file applications at **NO CHARGE**, in confidence, so we may present their qualifications to our clients.

## FOR SALE

## TRANSFORMER FACTORY

In large eastern market—Wonderful opportunity to buy completely equipped going concern, doing \$350,000. yearly business. \$85,000. cash required.

BO-876, Electronics  
330 W. 42nd St., New York City.

## EQUIPMENT FOR SALE

See page 432

## WANTED

## SALES MANAGER

Somewhere there is a Radio Parts Salesman or Sales Engineer now working for a manufacturer's agent, Jobber, or manufacturer of radio parts who has cut his eye teeth and is ready for a bigger job.

To such a man we offer a Real Postwar opportunity, with a hard hitting aggressive organization located in N. Y. Metropolitan area. This Company will have a quality line of Transformers and test equipment to be merchandised and sold thro' the Electronic jobber. Salary and participating basis. If you have the necessary qualifications we want to hear from you. Write fully, in confidence—

SW-851, Electronics  
330 West 42nd St., New York 18, N. Y.

## SALES MANAGER

Capable of taking complete charge of Sales Department of medium size manufacturing concern. Must have a working knowledge of either condensers, resistors or transformers. Should be familiar with the electronic manufacturing or jobbing industries. Unusual postwar opportunity. Write stating age, education, salary and previous connections.

SW-856, Electronics  
520 North Michigan Ave., Chicago 11, Ill.

## SALES MANAGER

Well established firm in East desires sales ability in field of Industrial Electronics as well as general sales for other Electronic Products. Post-war program offers unusual opportunity.

SW-828, Electronics  
330 West 42nd St., New York 18, N. Y.

## SALES ENGINEER WANTED

Should be a recent graduate in electrical engineering, interested in electronics for sales development, work on metals with many established electrical and electronic uses. Write history, experience, draft status, salary. Good postwar future with large company, New York.

SW-883, Electronics  
330 West 42nd St., New York 18, N. Y.

## SALES IN CHICAGO

Established Sales and Application Engineering organization in Chicago desires to represent and additional manufacturer. If you make products of merit used by Radio, Electronic and other manufacturers as part of their assemblies our efforts can secure substantial and permanent business for you. Write for details.

RA-782, Electronics  
520 N. Michigan Ave., Chicago 11, Ill.

## SALES ENGINEER

Graduate E. E. Practical and thorough knowledge of Radio, Television, Acoustics and Supersonics. Can set up sales organization, make market analysis, assist and guide development program. Have new product ideas and knowledge of electronics markets. Desire position of responsibility with progressive organization on earning basis. If you need sales-engineering executive with imagination, foresight and planning ability write

SA-888, Electronics  
520 North Michigan Ave., Chicago 11, Ill.

## NATIONAL DISTRIBUTION AVAILABLE

For Manufacturers who make products suitable for sale to radio and electronic jobbers. We have a complete sales staff for national and export distribution. Reply with samples and description of products.

RA-870, Electronics  
330 West 42nd St., New York 18, N. Y.



## Export for Profit

Roburn Agencies, Inc. have represented leading manufacturers of radio and electrical equipment, parts and accessories, in world-wide markets since 1935. Extensive facilities relieve you of all export headaches — correspondence, advertising, sales, finance, packing and shipping. A few additional clients seeking experienced, reliable representation are invited. Write for information on Profits Through Exports.



## Roburn Agencies, Inc.

115M Fulton Street New York 7, N. Y.

## RESALE PRODUCTS

### WANTED

For sale to jobbers, including automotive, oil, hardware and farm cooperatives, by well-rated corporation established 1903, staffed by personnel long experienced in radio and electrical merchandising. Basis, sales agency, or agency doing own billing and carrying accounts, or contract purchase. Can also prepare advertising. Territory, eastern seaboard, or national with west handled thru established affiliates.

## GENERAL PRODUCTS DIVISION

Attention—Julian A. Wesseler, Manager  
Automatic Fire Protection Company  
Englewood, N. J.

## To Electrical and Electronic Manufacturers Seeking

## SALES REPRESENTATION

In the N. Y. Metropolitan Area

An aggressive, hard hitting manufacturers' representative group, traveling three men who still know how to sell, are in position to give excellent representation to one or two additional lines having a real post-war future. Commission basis. Because of engineering background, we can handle items requiring technical skill. Your product will be in the finest company, as we represent two nationally-known quality lines selling to the best outfits. Write us in confidence. We can furnish highest references.

RA-875, Electronics  
330 W. 42nd St., New York 18, N. Y.

(Additional Employment Advertising on pages 416, 425, 432, 433, 434 & 435)

# Wanted....

## DEAN OF ENGINEERING....

For long established midwestern university having a total enrollment of 4,000 but with only 700 students enrolled in Electrical, Mechanical, Chemical, Civil, Aeronautical, and Metallurgical Engineering. The man desired should have experience and ability to administer the activities of about 30 professors.

Research work is also being conducted and that department is likewise under the administration of the Dean.

When replying feel assured that the letter is confidential, to be read only by the President, and your letter will be returned to you if you so request. To facilitate quicker action we will appreciate a rather complete reply stating your degrees, your teaching and administrative experience, scientific papers published and Research projects directed. Naturally we are interested in your personal background and you might state your salary preference.

While this position is open now, it can be held to await a release from military duty of a desirable candidate now so employed.

P-881, Electronics

520 North Michigan Ave., Chicago 11, Ill.

**WANTED**

## Electronic Tube Engineers

We have an opening in our organization with excellent post-war opportunities for capable engineers with experience in development, design or production of radio receiving or transmitting tubes.

*Apply*

**Hytron Radio & Electronics Corp.**  
432 Fourth Ave., New York 16, New York

**FOR SALE**

## 65 RADIO TRANSMITTERS

National-Trademark

**250 WATTS CARRIER**

**ON-PHONE-OR-TELEGRAPH**

Full Specifications Available on  
Written Request

## EMERSON RADIO & PHONOGRAPH CORP.

*Agent of*

**Reconstruction Finance Corp.**

*Handling all Types of*

**Electronic Equipment**

123 Duane Street N.Y. 17, N. Y.

**IMMEDIATE DELIVERY**

## New Laboratory Instruments

*Send for Our Latest Bulletin #101-7 on  
Electrical Control and Testing Apparatus*

## PAIO-MYERS INC.

81 Reade Street New York 7, N. Y.

## BEST QUALITY, USED ELECTRON TUBE MACHINERY

*Equipment for the manufacture of all kinds of  
electron tubes, radio tubes, incandescent lamps,  
neon tubes, photo electric cells, X-ray tubes, etc.*

## AMERICAN ELECTRICAL SALES CO., INC.

65-67 East 8th St. New York, N. Y.

# METERS

VOLTMETERS	BRIDGES (wheatstone)
AMMETERS	MEGOhmmeters
MICRO	RHEOSTATS
AMMETERS	VARIABLE
Ohmmeters	TRANSFORMERS
FREQ. METERS	RELAYS

*Ask for Our Latest Availability List*

## ELECTRO-TECH

EQUIPMENT COMPANY

329 Canal St., New York 13, N. Y.



**HELP WANTED  
TRANSFORMER &  
SMALL ELECTRIC  
MOTOR MEN  
ENGINEERS  
DESIGNERS  
DRAFTSMEN  
& Patent Draftsmen  
TECHNICIANS**

For war time and post-war design and development of intricate, specialized, hermetically sealed transformers, and special purpose fractional h.p. motors.

Write giving details about age, experience, past salaries to

**SPERRY**

**GYROSCOPE COMPANY, INC.**  
Research Laboratories  
Stewart Ave. & Clinton Rd.  
Garden City, New York

*Advancement*  
**For  
Electronics or Radio  
Engineers**

Large well-established organization located in New York City wants graduate Engineers with three or more years experience in

**ELECTRONICS  
RADIO  
RADAR  
SYNCHRO-MECHANISM**

For Present and Post-War research and development on a large variety of electrical products. Give us, in full confidence, your education, resume of experience, and photograph.

P-874, Electronics  
330 West 42nd St., New York 18, N. Y.

**SPEAKER  
LABORATORY  
ASSISTANT**

Eastern manufacturer, many years in business, with fine post-war picture can use young engineer, preferably with some speaker experience, to assist in design and development work. Fine opportunity. Salary open. State age, education and experience.

P-878, Electronics  
330 West 42nd St., New York 18, N. Y.

**ELECTRONIC ENGINEERS!**

**War-Winners Today, Post-War Builders Tomorrow!**

Leaders in NATIONAL UNION RADIO CORPORATION'S staff of engineers, scientists and technicians have brought us far out in front in the electronics industry. We have a research laboratory and two manufacturing plants in Newark, N. J., and a manufacturing plant near Philadelphia, Pa. We invite you to consider your opportunities with us for professional advancement, stimulating, friendly associations, and a future with promise.

**NATIONAL UNION NEEDS:**

**SENIOR TUBE ENGINEERS:** These men **MUST** have actual experience with radio tube manufacture. The pay and opportunities are commensurate with your ability.

**COMMERCIAL ENGINEERS:** Engineers interested in developing electronic tube applications, who may represent us among radio manufacturers upon occasion.

**QUALITY CONTROL MEN AND WOMEN:** Here you need an interest in the practical application of statistical and/or engineering procedures to many factory processes.

**TEST EQUIPMENT ENGINEERS:** Men experienced with meters or electronic test equipment to work either as **TEST EQUIPMENT DESIGN ENGINEERS** or as **MEASUREMENT LABORATORY ENGINEERS**.

**JUNIOR ENGINEERS—MEN AND WOMEN:** Do you have a college degree in Physics, Electrical Engineering, Chemical Engineering, Mechanical Engineering, Mathematics or Chemistry? This company offers an opportunity for young, ambitious graduates to assume responsibilities and to exercise initiative.

**WOMEN!**

*We have a number of fine young women engineers with us now. We need more. If you have a degree in Electrical Engineering, Chemical Engineering, Mechanical Engineering, Physics, Chemistry or Mathematics and are seeking career opportunities, investigate.*

If you have thorough training in your field, as evidenced by job experience in radio or allied industries, or by a college degree—if you have ambition, initiative and resourcefulness—if you have the ability to inspire your co-workers, then . . .

*Telephone or Write*

**DR. L. GRANT HECTOR**

*Director of Engineering*

**NATIONAL UNION RADIO CORPORATION**

Plane St. at Raymond Blvd.

Newark 2, New Jersey

**WMC RULES OBSERVED**

**WANTED**

**SENIOR  
DEVELOPMENT ENGINEER**

Large mid-west manufacturer, now exclusively on war radio and radar work, has immediate openings for post-war radio and television development for three senior radio project engineers, two mechanical engineers and one engineer on specifications and standards. Confidential inquiries respected. Write

P-813, Electronics  
520 N. Michigan Ave., Chicago 11, Ill.

**WANTED**

**RESEARCH ENGINEERS**

Prominent radio and electronics manufacturer located in Midwest has immediate openings for three research men preferably with engineering background, on post-war problems in electrical and electronic fields. Confidential inquiries respected.

P-815, Electronics  
520 N. Michigan Ave., Chicago 11, Ill.



**OPENINGS FOR  
RADIO  
ENGINEERS  
ELECTRICAL  
ENGINEERS  
MECHANICAL  
ENGINEERS**

In the development and production of all types of radio receiving and low-power transmitting tubes. Excellent post-war opportunities with an established company in a field having unlimited post-war possibilities.

Apply in person or in writing to:  
Personnel Manager

**RAYTHEON  
Manufacturing Company**  
Radio Receiving Tube Div.  
55 Chapel St., Newton, Mass.

**LOUD SPEAKER  
ENGINEER**

Large Eastern component parts manufacturer needs graduate engineer with several years design and development experience on loud speakers. Should be capable of handling developments through complete engineering design. Excellent post-war opportunity. Salary open. State full particulars, age, education and experience.

P-879, Electronics  
330 W. 42nd St., New York 18, N. Y.

**Permanent  
Post-War Job  
For  
Technical Writer**

• The man we want has spent the past two or three years writing instruction booklets on radio and radar equipment for some manufacturer. Cut backs soon will eliminate his job. He must be qualified to write at an advanced level instructional material on commercial broadcast receivers, AM and FM, television receivers, test equipment, industrial electronics equipment, service procedure, etc.

• An interview, at our expense, will be arranged for the right man. Job to begin at once or at earliest convenience. Salary depends on the man. Give full particulars of education, technical and writing experience, age, and other information in first letter.

P-880, Electronics,  
330 West 42d St., New York, N. Y.

**CHIEF  
ELECTRONICS  
ENGINEER**

KNOWLEDGE U. H. F.  
and all Military Tactical Equipment.  
Must be Able to Aid Further  
Development of Post War Products

FIRM ESTABLISHED SINCE 1888  
LOCATED IN NEW YORK CITY.  
BOX 7582, 113W42 NY

**MECHANICAL  
ENGINEER**

Experienced on small mechanical devices. Familiar with machine and sheet metal shop practices. For work on mechanical design of electro-mechanical and electronic test equipment.

THE ALLEN D. CARDWELL  
MANUFACTURING CORP.  
81 PROSPECT ST. BROOKLYN 1, N. Y.

**ELECTRONIC  
ENGINEERS**

SENIOR AND JUNIOR ENGINEERS WANTED FOR DESIGN AND DEVELOPMENT OF TEST EQUIPMENT, PRECISION WIRE WOUND RESISTORS, AND RF COILS. SHOULD HAVE PROVEN BACKGROUND IN THESE SUBJECTS.

**EASTERN ELECTRONICS  
CORP.**

41 Chestnut St. New Haven, Conn.

**ELECTRICAL ENGINEER**

Graduate - Technical and Patent Writing experience - Post War Opportunity. Write Background.

YARDENY LABORATORIES, INC.  
105 Chambers St. New York 7, N. Y.

**WANTED  
ASSISTANT  
CHIEF ENGINEER**

Mid-west radio-electronics manufacturer, engaged exclusively on electronic war projects at present, requires experienced engineer to assume complete supervision of post-war development of household and auto radio receivers. Television receiver experience desirable but not essential. All inquiries confidential. Write

P-814, Electronics  
520 N. Michigan Ave., Chicago 11, Ill.

**WANTED  
RADIO ENGINEER DRAFTSMAN**

For Development & Design of  
Electronic Equipment

INDUSTRIAL ELECTRONICS CORP.  
505 Court St., Bklyn., N. Y. Tr. 5-5350

**ELECTRICAL  
ENGINEERS**

Post War development Electronic Field. Degree necessary. Familiar with Micro Wave work. Good salary. Finest Lab equipment and working conditions.

P-887, Electronics  
330 West 42nd St., New York 18, N. Y.

**COMMUNICATION EQUIPMENT**

Technical and Production Engineers Required by midwest Manufacturer Essential War and Peace Product

P-850, Electronics  
520 N. Michigan Ave., Chicago 11, Ill.

**WANTED  
Radio Engineers and Technicians**

National Network in New York City  
Knowledge of Television helpful.

Write full details  
P-877, Electronics  
330 West 42nd St., New York 18, N. Y.

**ELECTRONIC ENGINEER**

As research and design engineer with vacuum tube hearing aid company. Must be graduate E.E. Some electronic and acoustical experience desired. Unusual opportunity to progress with aggressive company. Compensation secondary to provable ability. Permanent position. Describe education, experience, aptitudes and age. State salary desired. Apply in complete confidence.

P-873, Electronics  
330 West 42nd St., New York 18, N. Y.

**PRODUCTION MANAGER  
ALSO**

**TRANSFORMER ENGINEER**  
Experienced in taking charge of production of electrical apparatus. Very good future with growing manufacturing concern.

ADVANCE TRANSFORMER CO.  
1161 W. Madison St. Chicago 7, Ill.



# ENGINEERS

## Post-War Positions Open

A large expansion of our Engineering Division is now under way. We have many openings in many lines of engineering activity for both war and post-war work.

Among the positions open are:

- Senior Radio Engineers
- Electro-Mechanical Engineers
- Physicists
- Acoustic Engineers
- Tube Application Engineers
- Production Engineers
- Specification Engineers
- Aeronautical Radio Engineers

Our fields are Home and Auto Radio Receivers, Television Receivers, Commercial and Aeronautical Radio Receivers and Transmitters, Disc and Wire Recording. We require both design and research engineers in these fields.

Positions are permanent to qualified individuals. Salaries open.

Qualified individuals will be granted appointments for interviews in Buffalo at our expense.

Write stating education, experience and WMC status.

### COLONIAL RADIO CORPORATION

Engineering Division

1280 Main Street

Buffalo 9, New York

#### Chief Engineer or Senior Engineer

Moderate sized New York television & radio manufacturer now busy with war work but expanding very fast, which will do very substantial peacetime sales volume throughout U. S. A. and abroad, requires man with several years thorough experience in design and production of home receivers. Not a temporary, but a lifetime opportunity. To \$12,000 or more for right man.

P-869, Electronics  
330 West 42nd St., New York 18, N. Y.

#### Permanent Employment ELECTRONIC DEVELOPMENT ENGINEERS

Well-established Eastern Massachusetts concern desires graduate electronic engineers with flair for research and eye to future. Permanent position concerned at present with important development work for government with increased opportunities after the war. Unusual openings for men with capacity and initiative. Must be U. S. Citizens.

P-670, Electronics  
330 W. 42nd St., New York 18, N. Y.

#### WANTED TRANSFORMER Design, Research, Production ENGINEER

- Medium sized, progressive mid-west manufacturer has an opening for an unusual man.
- Knowledge of design and production of transformers for use in electronic applications as well as experience in fluorescent lighting transformers is essential. Ability to conduct research in these fields is also desirable.
- An unusual opportunity for a man with ability and initiative.

P-882, Electronics  
520 North Michigan Ave., Chicago 11, Ill.

#### CHIEF ENGINEER

Thoroughly familiar with the manufacture of capacitors, basically trained in the theory of dielectrics. Should be capable of directing the activities in a well equipped laboratory. Electrical Engineering or Electro-Chemical Engineering degree essential. This is an unusual opportunity for a capable engineer interested in his present and postwar future.

P-855, Electronics  
520 North Michigan Ave., Chicago 11, Ill.

#### PATENT ATTORNEY

Electrical Engineer Extensive experience—Post War Opportunity—Write Background.

YARDEN ENGINEERING CO.  
105 Chambers St. New York 7, N. Y.

#### Radio Engineers SEVERAL Electronic Engineers

for  
Research & Design Dept.

EXPERIENCED  
Magnetic Tape Field  
Receivers - Transmitters

Knowledge of Manufacture,  
Methods &  
Procedure Important

A REAL  
Post-War Opportunity

With Fast Growing  
Progressive N. Y. Manufacturer & Engineering Concern

Established over 10 years

Pioneers in  
Magnetic Recording Field

Write resume in detail

P-844, Electronics,  
330 West 42nd St., New York 18, N. Y.

# THE NEW SPEED IRON

Patents Pending

THE SUCCESSOR TO THE  
ELECTRIC SOLDERING IRON

100 WATTS  
115 VOLTS  
60 CYCLE

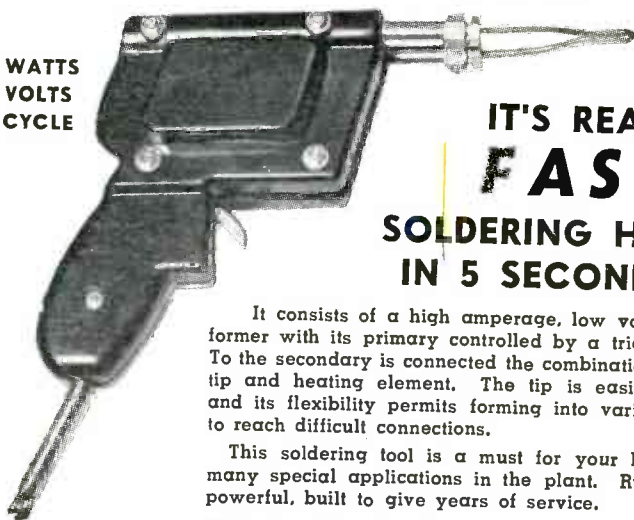

IT'S REALLY  
**FAST!**  
SOLDERING HEAT  
IN 5 SECONDS!

It consists of a high amperage, low voltage transformer with its primary controlled by a trigger switch. To the secondary is connected the combination soldering tip and heating element. The tip is easily replaced and its flexibility permits forming into various shapes to reach difficult connections.

This soldering tool is a must for your lab and for many special applications in the plant. Rugged, fast, powerful, built to give years of service.

Write for descriptive literature  
Prompt shipments being made on rated orders

PRICE \$12.95

If Your Supplier Does Not Yet Have the Speed Iron in Stock  
Send Your Order to

**WELLER MANUFACTURING CO.**  
DEPT E EASTON, PA.

ANNOUNCING  
a New Source for

THE STANDARD  
TELEPHONE TYPE  
**RELAY**

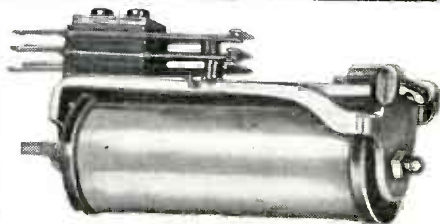

Built by CONTROL CORPORATION, long experienced in the application of Relays.

OPTIONAL FEATURES:

1. Double Arm
2. Delayed Operate or Release
3. Varnish Impregnated Coil
4. Tropicalization Treatment
5. Export Pack
6. Removable Cover
7. Plug and Socket Mounting

Inquiries and orders given prompt, courteous attention.

WRITE — WIRE — PHONE

**CONTROL CORPORATION**  
600 STINSON BLVD.  
Phone Granville 8897  
MINNEAPOLIS 13, MINN.

ARGON HELIUM KRYPTON  
NEON XENON MIXTURES

*Linde*

RARE GASES  
AND MIXTURES



... Spectroscopically Pure  
... Easily removed from bulb  
without contamination

Scientific uses for LINDE rare gases include—

1. The study of electrical discharges.
2. Work with rectifying and stroboscopic devices.
3. Metallurgical research.
4. Work with inert atmospheres, where heat conduction must be increased or decreased.

Many standard mixtures are available. Special mixtures for experimental purposes can be supplied upon request.

The word "Linde" is a trade-mark of

**THE LINDE AIR PRODUCTS COMPANY**  
Unit of Union Carbide and Carbon Corporation  
30 E. 42nd St., New York 17 N.Y. Offices in Principal Cities  
In Canada: Dominion Oxygen Company, Ltd., Toronto

## ALDEN FUSEHOLDER

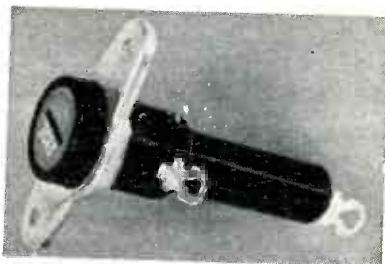

Here is a patented fuseholder that uses the machines and tools in your assembly line. It eyelets or rivets in place, has spring to eject burned out fuse, prevent rattle, and open side contact for easy removal of fuse ends when glass breaks.

NA-ALD

**ALDEN PRODUCTS COMPANY**  
BROCKTON 64E, MASS.

*New England  
Screw Co.*  
KEENE, NEW HAMPSHIRE



**50**  
YEARS OF  
SPECIALIZED EXPERIENCE

MACHINE SCREWS PLASTIC INSETS  
SHEET METAL SCREWS HOLDING PINS  
MACHINE SCREW NUTS SPECIAL RIVETS

ALL TYPES OF HEADS AND THREADS



# INDEX TO ADVERTISERS

	Page		Page
Acheson-Colloids Corporation	73	Continental Electric Co.	399
Acme Electric & Mfg. Co.	376	Control Corporation	436
Acro Electric Co.	196	Cook Electric Company	268
Advance Electric & Relay Co.	232	Cornell-Dubilier Electric Corp.	59
Aerovox Corporation	391	Corning Glass Works	80
Air Reduction	425	Cornish Wire Company, Inc.	316
Aircraft & Diesel Equipment Corp.	372	Coto-Coil Co., Inc.	276
Aircraft-Marine Products, Inc.	369	Cross, H.	429
Aireon Manufacturing Corp.	41	Crystal Research Laboratories, Inc.	256
Albion Coil Co.	341	Crystal Trading Co.	429
Alden Products Co.	436		
Allegheny Ludlum Steel Corp.	17		
Allied Control Co., Inc.	259	Dalis, Inc., H. L.	332
Allied Radio Corp.	168	Daven Company	Inside Back Cover
Allis-Chalmers Mfg. Co.	22, 23	Dayton Rogers Mfg. Co.	376
Altec Lansing Corp.	27	DeJur Amsco Corporation	375
Amalgamated Radio Television Corp.	260	Delco Radio, Div. of General Motors	355
American Condenser Co.	352	Deutschmann Corp., Tobe	6
American Electrical Heater Co.	282	Dial Light Co. of America, Inc.	302
American Gas Accumulator Co.	290	Diamond Instrument Co.	76
American Gas & Chemical Co.	422	Diebel Die & Mfg. Co.	294
American Lava Corporation	363	Dinon Coil Co.	312
American Lens Co., Inc.	269	Dixon's Typhonite ELDORADO Pencils	430
American Phenolic Corp.	229, 419	Dobeckmun Company, The	257
American Platinum Works	356	Dongan Electric Mfg. Co.	422
American Screw Co.	178	Doolittle Radio, Inc.	406
American Time Products, Inc.	274	Dow Chemical Co.	161
American Transformer Co.	185	Dow Corning Corporation	247
Amperex Electronic Corporation	Inside Front Cover	Drake Electric Works, Inc.	368
Amperite Co.	406	Drake Manufacturing Co.	324
Anaconda Wire & Cable Co.	165	Driver-Harris Co.	37
Andrew Co.	188	Dumont Electric Co.	15
Arkwright Finishing Co.	415	DuMont Laboratories, Inc., Allen B.	56
Armstrong Mfg. Co.	429	du Pont de Nemours & Co. (Inc.), E. I.	315
Arnold Engineering Co.	74	Durez Plastics & Chemicals, Inc.	233
Art Wire & Stamping Co.	427	DX Radio Products Co.	348
Associated Research, Inc.	340	Dynamic Air Engineering, Inc.	77
Astatic Corporation	200	Dzus Fastener Co., Inc.	227
Audak Co.	439		
Audio Development Co.	288	Eastern Air Devices, Inc.	10
Audio Devices, Inc.	18	Eastern Amplifier Corporation	313
Auto Engraver Co.	418	Fby, Inc., Hugh H.	344
Automatic Electric Sales Corp.	357	Ecor, Inc.	342
Automatic Mfg. Corporation	162	Eisler Engineering Co.	414, 429
		Eitel-McCullough, Inc.	89
Bakelite Corporation	201	Elastic Stop Nut Corp. of America	275
Ballantine Laboratories, Inc.	354	Elco Resistors Company	224
Barker & Williamson	242	Electric Indicator Co.	414
Belden Mfg. Co.	255	Electrical Industries, Inc.	416
Bell Sound Systems, Inc.	290	Electrical Insulation Co., Inc.	356
Bell Telephone Laboratories	60, 61	Electrical Reactance Corp.	316
Bendix Aviation Corp., Pacific Div.	261	Electrix Corporation	414
Bentley, Harris Mfg. Co.	237	Electronic Engineering Co.	332
Benwood-Linze Co.	210	Electronic Enterprises, Inc.	70
Best Manufacturing Co., Inc.	309	Electronic Measurements Co.	404
Biddle Co., James G.	310	Electronic Mechanics, Inc.	84
Blaw-Knox Company	396	Electronic Winding Co.	346
Boonton Radio Corp.	316	Engineering Co.	368
Bradley Laboratories, Inc.	231	Erco Radio Laboratories, Inc.	388
Brand & Co., William	171	Ericsson Screw Machine Products Co., Inc.	282
Breeze Corporations, Inc.	351	Erie Resistor Corp.	34
Bridgeport Mfg. Co.	194	Espey Manufacturing Co., Inc.	328
Browning Laboratories, Inc.	337	Essex Electronics	437
Bruning Company, Inc., Charles	379	Essex Wire Corporation	339
Brush Development Co.	314		
Bud Radio, Inc.	418	Federal Tel. & Radio Corp.	47, 245, 416
Burgess Battery Co.	296	Fenwal, Inc.	407
Burlington Instrument Co.	350	Ferranti Electric, Inc.	190
Burndy Engineering Co.	72	Finch Telecommunications, Inc.	312
Burstein-Applebee Co.	429	Fisher-Pierce Company	358
		Follansbee Steel Corporation	322
Callite Tungsten Corp.	33	Foot Mineral Co.	225
Cambridge Thermionic Corporation	9	Ford Radio & Mica Corp.	404
Cannon Electric Development Co.	400	Formica Insulating Company	291
Capacitron Company	238	Foster Company, A. P.	220
Capitol Radio Engineering Institute	422	Franklin Mfg. Corp., A. W.	32
Carborundum Company	173	Freeland & Olschner Products, Inc.	429
Cardwell Mfg. Corp., Allen D.	184		
Carter Motor Co.	412	Gates Radio Co.	273
Celanese Corp. of America.	285	Gear Specialties	79
Cellusuede Products, Inc.	348	General Cable Corp.	4, 5
Central Paper Co., Inc.	294	General Cement Mfg. Co.	429
Centralab, Div. of Globe-Union, Inc.	48	General Ceramics & Steatite Corporation	241
Chace Co., W. M.	180	General Control Co.	353
Chatham Electronics	55	General Electric Co., 11, 12, 13, 14, 52, 158, 159, 277, 371, 378, 410,	53, 425
Cherry Rivet Company	287	General Industries Company	249
Chicago Metal Hose Corp.	398	General Instrument Corp.	297
Chicago Telephone Supply Co.	44	General Magnetic Corp.	290
Chicago Transformer Corp.	405	General Plate Div. of Metals & Controls Corp.	335
Cinadagraph Corporation	383	General Radio Company	385
Cinch Mfg. Corp.	145	General Tire & Rubber Co.	295
Cinema Engineering Co.	362	Glaser Lead Co.	376
Clare & Co., C. P.	16	Glendale Vacuum Products Co.	429
Clarostat Mfg. Co., Inc.	330	Goat Metal Stampings, Inc.	372
Cohn & Co., Sigmund	272	Goat Metal Stampings, Co., B. F.	440
Cole Steel Equipment Co.	206	Gnodrich Chemical Co.	286
Collins Radio Co.	169	Gothard Manufacturing Company	380
Columbia Wire & Supply Co.	364	Gould-Moody Co.	320
Communications Company, Inc.	246	Gramer Company	364
Communication Measurements Laboratory	423	Graphite Metallizing Corp.	234
Conant Electrical Laboratories	264	Green Electric Company, Inc., W.	418
Concord Radio Corporation	417	Greenlee Tool Co.	213
Condenser Products Company	420	Guardian Electric Mfg. Co.	332
Connecticut Telephone & Electric Division of G. A. I.	367	Guided Radio Corporation	332
Continental-Diamond Fibre Co.	405		

ONE OF A SERIES...

ESSEX

Showing our complete manufacturing facilities from raw materials to finished product!



MODERN TESTING FACILITIES

for 100% checking "Q" and

inductance to close tolerances.

Each ESSEX product must undergo a series of exacting tests before release for final delivery. Measurements for accuracy and performance are made in a complete and modern testing laboratory under the supervision of veteran radio engineers. Careful attention to details of product design and the use of the ultimate in testing equipment has resulted in the development of electronic components which meet the most rigid requirements.

Precision manufacturers of all types of IF and RF coils, chokes, and transformers.

ESSEX ELECTRONICS  
1060 Broad St., Newark, N. J.



	Page
Spencer Wire Co.	235
Sprague Electric Co.	57
Stackpole Carbon Co.	289
Stamford Metal Specialty Co.	422
Standard Pressed Steel Co.	318
Standard Transformer Corp.	156
Star Expansion Products Co.	364
Star Porcelain Co.	418
Sta-Warm Electric Co.	360
Stevens Walden, Inc.	428
Steward Mfg. Co. D. M.	420
Struthers-Dunn, Inc.	239
Stupakoff Ceramic & Mfg. Co.	36
Super Electric Products Corp.	392
Superior Electric Co.	202
Supreme Instruments Corp.	82
Sylvania Electric Products, Inc.	198
Synthane Corporation	30, 31

Taylor Fibre Co.	181
Tech Laboratories	192
Technical Radio Company	251
Teleso Products, Inc.	402
Telex, Inc.	172
Templone Radio Mfg. Corp.	226
Thermador Electrical Mfg. Co.	215
Thomas & Skinner Steel Products Co.	420
Tinnerman Products, Inc.	189
Transmitter Equipment Mfg. Co., Inc.	19
Traver Corporation	283
Triplet Electrical Instrument Co.	345
Tung-Sol Lamp Works, Inc.	263

Ucinite Company	170
Union Carbide & Carbon Corp.	201, 333, 436
United Catalog Publishers, Inc.	430
United Electronics Co.	38
United Transformer Corp.	2
Utah Radio Products Company	193

Victoreen Instrument Co.	308
Victory Manufacturing Co.	320
Volkel Brothers Machine Works	280

Walker-Jimieson, Inc.	378
Walker-Turner Co., Inc.	413
Wallace Mfg. Co., Wm. T.	320
Wallace & Tiernan Products, Inc.	64
Walcham Screw Co.	410
Ward Leonard Electric Co.	186
Ward Products Corporation	424
Warren Telechron Co.	197
Waugh Laboratories	85
Webster Chicago Corporation	327
Webster Electric Co.	334
Weller Mfg. Co.	436
Western Electric Co.	60, 61, 425
Westinghouse Electric Corporation	43, 177, 267
Weston Electrical Instrument Corp.	321
Whistler & Sons, Inc., S. B.	221
Whitaker Cable Corp.	24
White Dental Mfg. Co., S. S.	347
Whitehead Stamping Co.	425
Willor Manufacturing Corp.	394
Wilson Co., H. A.	78, 254
Wincharger Corporation	302
Workshop Associates, The	317

Zenith Optical Laboratory	256
Zophar Mills, Inc.	328

PROFESSIONAL SERVICES	428
-----------------------	-----

SEARCHLIGHT SECTION  
(Classified Advertising)

EMPLOYMENT	416, 425, 431-435
USED EQUIPMENT	
American Electric Sales Co., Inc.	432
Electro-Tech Equipment Co.	432
Emerson Radio & Phonograph Corp.	432
Palo-Myers Inc.	432

THE IMPORTANCE OF

*Specialization*

IS FORCEFULLY  
DEMONSTRATED BY

**Audax**



Aside from outstanding and long-acknowledged technical skill — our “Specialization Formula” is probably as fully responsible for the world-renowned AUDAX quality as any other single factor.

We proudly concentrate all our energies and resources upon producing the finest pick-ups and cutters. Because we are specialists in this field, much more is expected of us. Because the production of fine instruments like MICRODYNE is a full time job, it stands to reason that we could not afford to jeopardize our reputation—EVER—by making pick-ups a side-line.

After Victory, you may expect further AUDAX improvements, refinements . . . master-touches to heighten the marvelous *fac simile* realism of AUDAX reproduction.

**AUDAX COMPANY**

500E Fifth Avenue, New York 18

“Creators of Fine Electronic-Acoustical Apparatus since 1915”

*“The Standard  
by Which Others  
Are Judged and Valued”*



Send for complimentary copy of our informative  
“PICK-UP FACTS”

What types of wire insulated with Geon should be used in this home?

T HOUSE WIRE TW HOUSE WIRE  
 UNDERGROUND SERVICE ENTRANCE CABLE  
 APPLIANCE CORD LAMP CORD  
 FIXTURE WIRE TELEPHONE WIRE RADIO WIRE

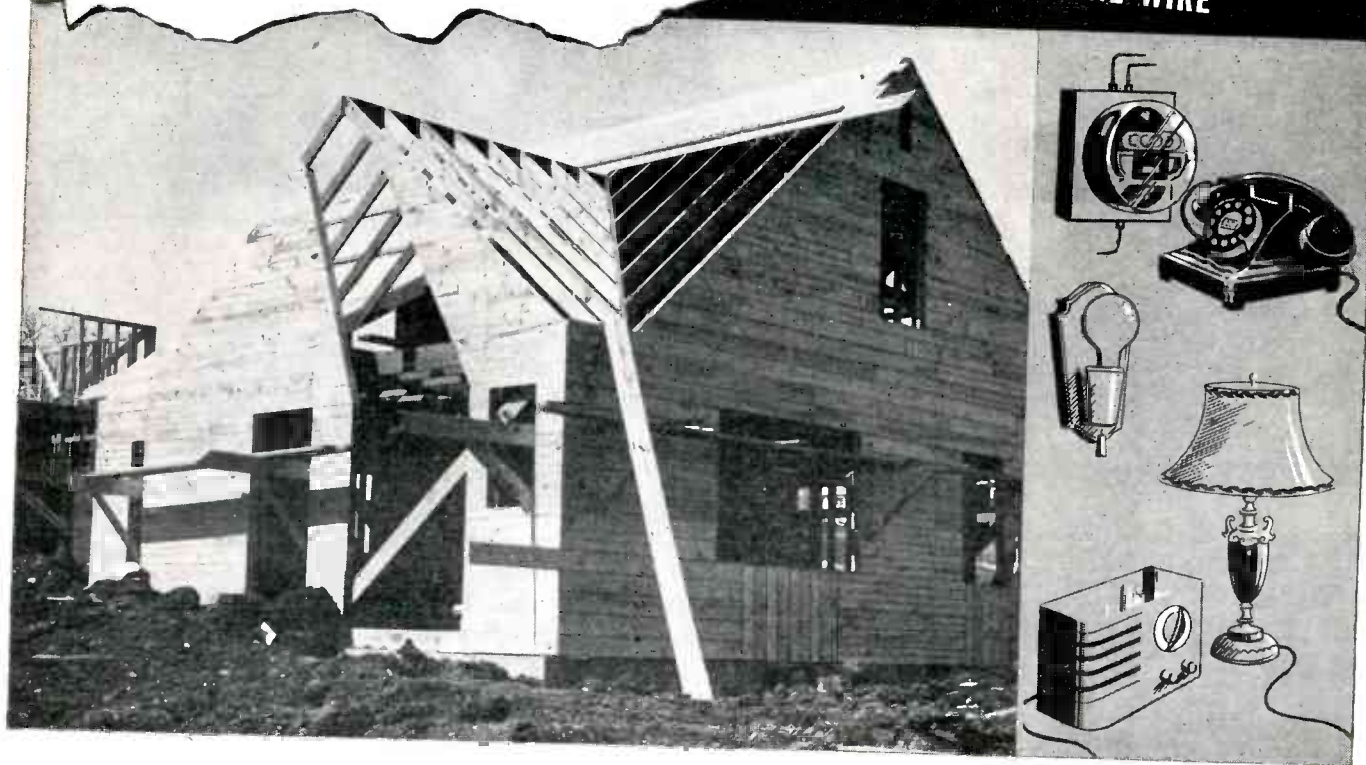

THE coming construction boom will bring with it a boom in the use of wire and cable insulation made from GEON polyvinyl materials. That's because GEON is being used as insulating material for *all* types of domestic wiring with the exception of cord for certain types of heating units such as toasters, roasters, irons or home heaters. And there's reason to believe that these applications may soon be on the list.

The versatility of insulation made from GEON is graphically demonstrated by its use for underground power cable on the one hand and as "spaghetti" for fine radio wire on the other.



The use of wire insulation made from GEON will bring with it many advantages in addition to GEON's excellent electrical properties. Ease of installation, for example, is one; and resistance to water, chemicals, air, aging, ozone, abrasion, heat, cold and many other normally destructive factors. Insulation made from GEON may be colored in the entire NEMA range.

Specify insulation made from GEON when you order from your manufacturer or wholesaler. Or, for information regarding special applications, write Department FF-8, B. F. Goodrich Chemical Company, Rose Building, Cleveland 15, Ohio.

**B. F. Goodrich Chemical Company**

A DIVISION OF  
 THE B. F. GOODRICH COMPANY

August 1945 — ELECTRONICS

Presenting the...

# DAVEN

WIRE-WOUND  
SEALD-OHM

## HERMETICALLY-SEALED PRECISION RESISTOR



Totally unaffected by extremes of humidity and temperature, highly resistant to vibration and shock, with provision for rigid mounting... these were "specs" that could not be met by any resistor on the market. In response to a direct request, DAVEN, applying the know-how of over two decades of precision resistor engineering, carefully designed and built a new, completely hermetically-sealed resistor. DAVEN SEALD-OHMS squarely meet these specifications. This was proven by exhaustive tests conducted by a famous research laboratory.

### ELECTRICAL DATA

**RESISTOR WINDINGS:** Either spool or mica-card type, depending upon engineering requirements. Non-inductively wound and carefully aged to remove strain before final calibration.

**RESISTANCE RANGE:** Any desired value may be had; maximum 1,600,000 ohms depending upon type of resistance wire employed.

**TEMPERATURE CHARACTERISTICS:** Four types of resistance wire of different characteristics are available.

**ACCURACY:** May be had to tolerance as close as  $\pm 0.1\%$ .

**FREQUENCY CHARACTERISTICS:** No appreciable effect over the audio range. This range may be exceeded to meet many other applications.

**CIRCUIT COMBINATIONS:** Resistors available with 2 terminals at one end or 2 terminals at two ends. A single four terminal unit is designed to take up to four separate spool-type resistors of different values and accuracies.

SEALD-OHMS are ruggedly constructed throughout, with special attention given to combining vibration and shock resistance. Their physical design enables the combining of several circuits within a single unit. A unique mounting bracket arrangement adds to the broad adaptability of these resistors. SEALD-OHMS are intended for use in any equipment subjected to humidity and temperature extremes. They fully meet both Army and Navy Specifications. Typical applications include as secondary standards, resistor elements in bridge networks, in voltage divider circuits, in attenuation boxes, etc.

### MECHANICAL DATA

**SHIELDING:** Drawn brass, completely hermetically-sealed. Thermal-shock tested for faulty seals before shipment. Treated to withstand 200 hours salt spray test (f-13 AWS Spec C75.16-1944).

**TERMINALS:** Electrical connections are brought out through fused glass seals which are soldered in the resistor shield.

**MOUNTING:** A specially designed steel bracket with spade lugs welded to the sides is supplied with each unit. Cut-outs on this bracket engage with embossings on the side of the brass shielding to enable firm mounting of the unit in a vertical, inverted or horizontal position.

**DIMENSIONS:** 1-9/16" wide, 1/2" high, 7/8" deep. Add terminal height, 9/16" Studs on mounting bracket, 1-11/16" between centers.

For additional information, write to THE DAVEN CO.,  
191 Central Avenue, Newark 4, New Jersey

DAVEN **pioneer** maker of precision resistors



**For dependability, compactness,  
simplicity, economy—consider  
RCA Beam-Power Tubes  
when designing transmitters**



**Beam-power tubes provide simple, compact equipment —  
a wide range of power output — high power-sensitivity —  
over-all efficiency and economy.**



**IN AM TRANSMITTERS:** Beam-power transmitting tubes provide high output with low driving-power. They enable you to design more compact, simpler, more economical broadcast transmitters than other types of tubes.

**IN TELEVISION TRANSMITTERS:** The high-gain and self-neutralizing properties of beam-power tubes make possible stable, efficient wide-band video and r-f amplifiers, with a minimum of tubes and without neutralizing circuits.



Transmitters designed around beam-power tubes are *more compact* because fewer stages are required and because neutralizing circuits are eliminated; they are *more simple* because the transmitter does not have to be re-neutralized each time tubes are replaced; they are *more economical* because fewer tubes and fewer stages can be used for a given power-output.

**LOOK TO RCA FOR YOUR TUBES:** In beam-power transmitting tubes, RCA has developed a whole family of high-performance champions such as the RCA-807, 813, 814, 815, 828, 829B, and 832A—the *most complete line offered by any manufacturer!*

**IN FM TRANSMITTERS:** The self-neutralizing property of beam-power tubes provides a simple, efficient means of obtaining stable operation in wide-band FM circuits without complex auxiliary circuits.

For complete technical information on RCA beam-power tubes, see the RCA HB-3 Handbook. If you do not have a copy of this handbook, or if you have questions on the application of beam-power tubes, write to RCA, Commercial Engineering Department, Section 62-33E, Harrison, N. J.

The Fountainhead of Modern  
Tube Development is RCA



62-6136-33

*Buy War Bonds!*

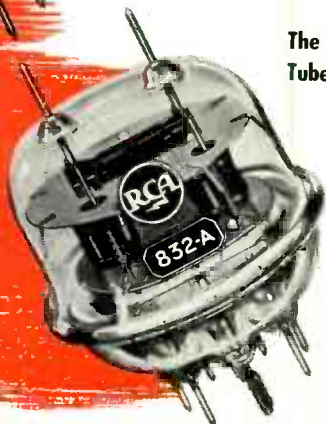

**RADIO CORPORATION OF AMERICA**

RCA VICTOR DIVISION • CAMDEN, N. J.